



Biophysics

An Introduction



Dadan Rosana



UNIVERSITAS NEGERI YOGYAKARTA

2020

Preface

Biophysics is an interdisciplinary science somewhere between biology and physics. The development of biophysics is closely connected with the intensive interpenetration of ideas, theoretical approaches, and methods of modern biology, physics, chemistry, and mathematics. Biophysics is the science that investigates the physical and physicochemical processes taking place in living organisms, and also the ultrastructure of biological systems on all levels of organization of living material, from submolecular and molecular to cells and entire organisms. The subjects of Biophysics are the physical principles underlying all processes of living systems. This also includes environmental biophysics, which represents physical influences on physiological functions.

The term “biophysics” was first used in 1892 by Karl Pearson in his book “The Grammar of Science.” Modern biophysics, according to the classification accepted by the International Union of Pure and Applied Biophysics (1961), includes the following basic branches: molecular biophysics, which consists in the investigation of the physical and physicochemical properties of the macromolecules and molecular complexes that compose living organisms, and also the character of the interactions and the energetics of the processes that take place in them; cellular biophysics, which studies the physicochemical basis of cell function, the connection of the molecular structure of membranes and cell organelles with their functions and mechanical and electrical properties and with the energetics and thermodynamics of cellular processes; and the biophysics of control and regulatory processes, which deals with the investigation and modeling of the internal connections of control systems in the organism, their physical nature, and the physical mechanisms of life at the level of the entire organism. Biophysics may be thought of as the central circle in a two-dimensional array of overlapping circles, which include physics, chemistry, physiology, and general biology. Relations with chemistry are mediated through biochemistry and chemistry; those with physiology, through neurophysiology and sensory physiology. Biology, which may be viewed as a general subject pervading biophysical study, is evolving from a purely descriptive science into a discipline increasingly devoted to understanding the nature of the prime movers of biological events.

This book is written to meet the needs of graduate students studying Biophysics, especially in math and science faculty, so that the depth of this book adapted to the characteristics of the students. Therefore this book is intended as an introduction to further deepen the level of biophysical matter further.

Finally, the authors would like to thank the Office of International Affairs and Partnerships, Yogyakarta State University, to management support and funding. This book of course is far from perfect, as it critiques and suggestions from colleagues and students are expected to improve the quality of this book.

Author

TABLE OF CONTENT

Preface	i
Table of Content	ii
CHAPTER 1 Structure and Function of Cells	1
CHAPTER 2 The Cell Membrane	25
CHAPTER 3 Metabolism and Energy Transformation	52
CHAPTER 4 Protein Structure	73
CHAPTER 5 Protein Function	95
CHAPTER 6 Structure and Function of DNA	116
CHAPTER 7 Structure and Function of RNA	134
CHAPTER 8 Force on Human Body	150
CHAPTER 9 Pressure and Fluid Flow in The Body	178
CHAPTER 10 The Bioelectric Cell	203
CHAPTER 11 The Body Electricity	225
CHAPTER 12 Hearing	247
CHAPTER 13 Vision	267

CHAPTER 1

STRUCTURE AND FUNCTION OF CELLS

The cell (from Latin *cella*, meaning "small room") is the basic structural, functional and biological unit of all known living organisms. Cells are the smallest unit of life that can replicate independently, and are often called the "building blocks of life" (http://en.wikipedia.org/wiki/Cell_biology). The cell is the structural integrity, functional, and hereditary smallest of living creatures in the form of a small space bounded by membranes and contains a concentrated liquid. In Becker. et al (2000:2) mentioned that the cell is the basic unit of biology.

Cells consist of a protoplasm enclosed within a membrane, which contains many biomolecules such as proteins and nucleic acids. Organisms can be classified as unicellular (consisting of a single cell; including most bacteria) or multicellular (including plants and animals). While the number of cells in plants and animals varies from species to species, humans contain about 100 trillion (10^{14}) cells. The cells come from preexisting cells and have a life of their own in addition to their joint role in the multicellular organism. Most living things are composed of single cells. or so-called unicellular organisms. such as bacteria and amoeba. Other living things. including plants. animals. and humans, are multicellular organisms composed of many specialized cell types with their respective functions Most plant and animal cells are visible only under the microscope, with dimensions between 1 and 100 micrometres. The human body is composed of more than 1013 cells. Nevertheless. the whole body of all organisms derived from a single cell division results. For example, the body of bacteria derived from the parent bacterial cell division, while the bodies of mice derived from cell division of the fertilized egg parent.

The cell was discovered by Robert Hooke in 1665. The cell theory, first developed in 1839 by Matthias Jakob Schleiden and Theodor Schwann, states that all organisms are composed of one or more cells, that all cells come from preexisting cells, that vital functions of an organism occur within cells, and that all cells contain the hereditary information necessary for regulating cell functions and for transmitting information to the next generation of cells.^[5] Cells emerged on Earth at least 3.5 billion years ago.

Approximately 200 years later, Dutrochet. von Scheleiden. and Schwaan Hook confirms discovery. In 1824. R.J.H. Dutrochet cells expressed the principle which states that all animals and plants are composed of cells that stick together by the force of the adhesive. Then in 1838. M.J. Scheleiden published a book that includes an understanding of the genesis of plant tissue. Scheleiden finding suggests the presence of nucleoli and cell theory in plants. Meanwhile next year. T. Schwaan put forward the theory in animal cells. Cell theory states that living things are composed of cells. The discovery of the cell theory above Durjadin line with findings in 1835 that found that in the cell there is a viscous substance. which is now known as protoplasm.

In 1839, Theodor Schwann, who after discussing with Schleiden realized that he had observed the nucleus of the animal cell as Schleiden studied in plants, suggesting that all animal parts are also made up of cells. According to him. the universal principle of formation of various body parts of all organisms is the cell formation. In the mid-19th century, in 1958.

R. Virchow put forward the theory that corrects the theory of abiogenesis biogenesis. Biogenesis theory states that all living cells come from cells that already exist. The concept was popular with *Omnis cellula cellulae*. Later in the 20th century that many experts find various types of structures and formations contained within the cell. For example, in 1867, L. ST. George found the cell organelles are now called - Golgi complex. In 1869, F. Meischer find nuclein. and in 1887, van Beneden find centrioles.

The cell is the smallest unit of life. All organisms alive today, derived from a stem cell existing in millions of years ago. These cells undergo a gradual evolution going to adjust to its environment. Based on these changes, it is now the cell can be grouped into two major groups, namely prokaryotic cells (prokaryotic) and eukaryotic cells (eukaryotic). Prokaryotic and eukaryotic term first used by Hans Ris in 1960.

Eukaryotic cells are distinguished from the more primitive **prokaryotic cells** by the presence of **1) cytoplasmic membranous organelles**, **2) a nuclear membrane** (i.e. a true nucleus), and **3) chromosomal proteins**. In this lab we will focus primarily on organelles, their functions within the cell and how they differ between plant and animal cells.

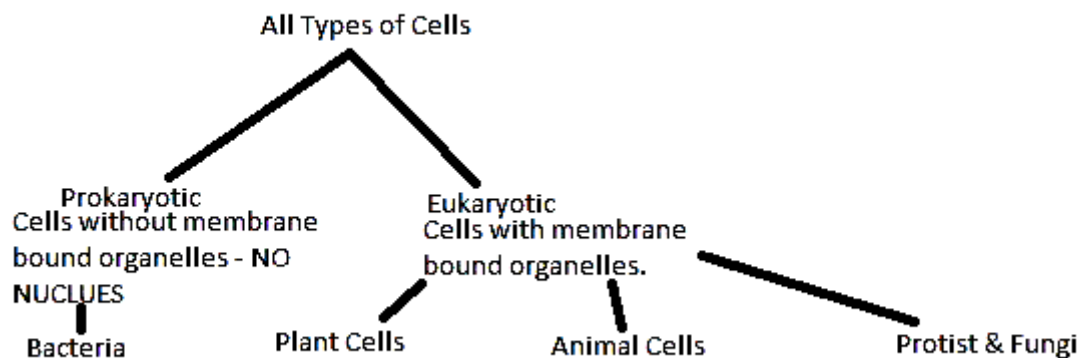

Figure 1.1. All types of cells(<http://mrsgiegler.weebly.com/2/archives/10-2011/1.html>)

Important discoveries about cells growing in line with advances in technology and the discovery of advanced tools. Until now it is known that the structure and cell activity is not as simple as previously thought. For more details schemes cell development and cell theory can be seen in the figure below.

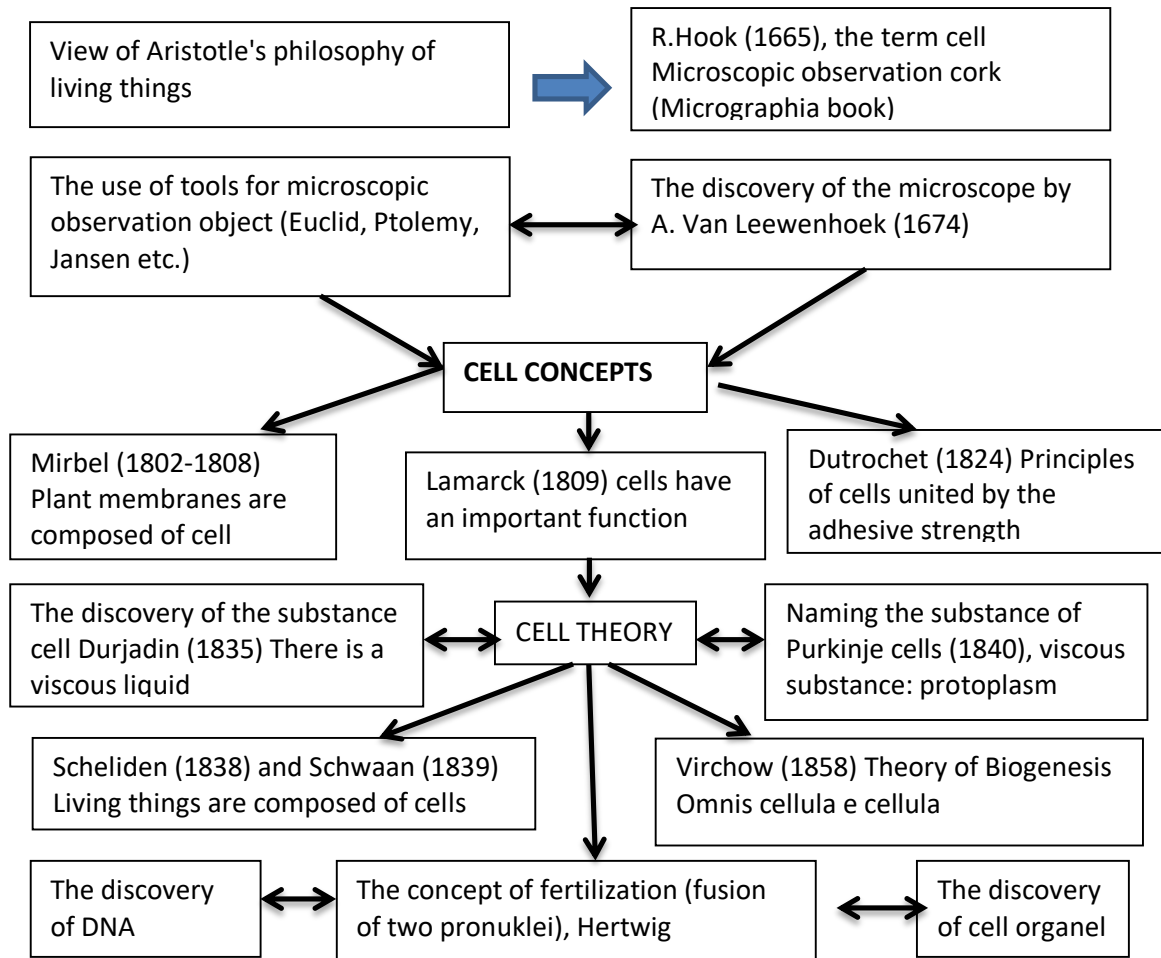

Figure 1.2. Schemes cell development and cell theory

A. Prokaryotic Cells

Cells that lack a membrane-bound nucleus are called prokaryotes (from the Greek meaning before nuclei). These cells have few internal structures that are distinguishable under a microscope. Cells in the monera kingdom such as bacteria and cyanobacteria (also known as blue-green algae) are prokaryotes. Prokaryotes are single-celled organisms that are the earliest and most primitive forms of life on earth. As organized in the Three Domain System, prokaryotes include bacteria and archaeans. Prokaryotes are able to live and thrive in various types of environments including extreme habitats such as hydrothermal vents, hot springs, swamps, wetlands, and the guts of animals. Most are unicellular, but some prokaryotes are multicellular.

Prokaryotic cells are the simplest systems that exhibit all of the signs of life. They are the smallest types of cell, averaging 2-5 μm in length, which makes them just visible under the light microscope. Prokaryotic cells differ significantly from eukaryotic cells. They don't have a membrane-bound nucleus and instead of having chromosomal DNA, their genetic information is in a circular loop called a plasmid. Bacterial cells are very small, roughly the size of an animal mitochondrion (about 1-2 μm in diameter and 10 μm long). Prokaryotic cells feature three major shapes: rod shaped, spherical, and spiral.

Instead of going through elaborate replication processes like eukaryotes, bacterial cells divide by binary fission.

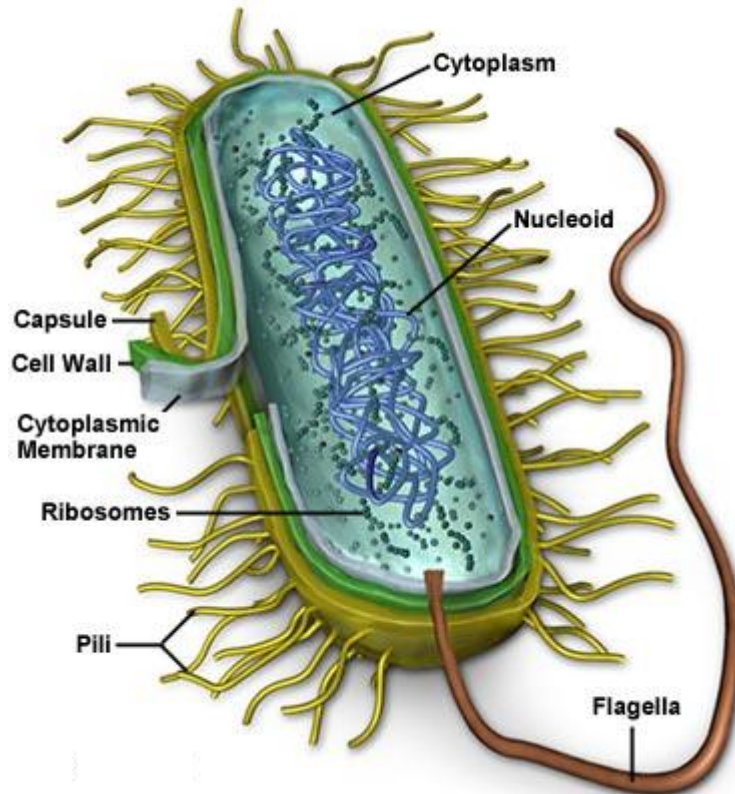

((<http://www.cellsalive.com/cells>))

Figure 1.3. The structure of the bacterial cell.

Bacteria perform many important functions on earth. They serve as decomposers, agents of fermentation, and play an important role in our own digestive system. Also, bacteria are involved in many nutrient cycles such as the nitrogen cycle, which restores nitrate into the soil for plants. Unlike eukaryotic cells that depend on oxygen for their metabolism, prokaryotic cells enjoy a diverse array of metabolic functions. For example, some bacteria use sulfur instead of oxygen in their metabolism (http://library.thinkquest.org/C004535/prokaryotic_cells.html).

Despite their small size, inside each cell there is the complete chemical and biochemical machinery necessary for growth, reproduction and the acquisition and utilization of energy. Prokaryotes have a large array of abilities. Some of them live in the absence of oxygen, some live in extreme conditions of heat or cold, others at the bottom of oceans where the only source of energy is hot hydrogen sulfide bubbling up from the core of the earth.

Prokaryotic cells are not as complex as eukaryotic cells. They have no true nucleus as the DNA is not contained within a membrane or separated from the rest of the cell, but is coiled up in a region of the cytoplasm called the nucleoid. Using bacteria as our sample prokaryote, the following structures can be found in bacterial cells (<http://biology.about.com/od/cellanatomy/ss/prokaryotes.htm>):

1. **Capsule** – A gelatinous capsule is present in some bacteria outside the cell membrane and cell wall. The capsule may be polysaccharide as in pneumococci, meningococci or polypeptide as *Bacillus anthracis* or hyaluronic acid as in streptococci. Capsules are not marked by normal staining protocols and can be detected by India ink or methyl blue; which allows for higher contrast between the cells for observation. Found in some bacterial cells, this additional outer covering protects the cell when it is engulfed by other organisms, assists in retaining moisture, and helps the cell adhere to surfaces and nutrients.
2. **Cell Wall** - Outer covering of most cells that protects the bacterial cell and gives it shape. The cell wall acts to protect the cell mechanically and chemically from its environment, and is an additional layer of protection to the cell membrane. Different types of cell have cell walls made up of different materials; plant cell walls are primarily made up of pectin, fungi cell walls are made up of chitin and bacteria cell walls are made up of peptidoglycan.
3. **Cytoplasm** - A gel-like substance composed mainly of water that also contains enzymes, salts, cell components, and various organic molecules. The **cytoplasm** in prokaryotic cells is a gel-like, yet fluid, substance in which all of the other cellular components are suspended. Jello for cells. It is very similar to the **eukaryotic cytoplasm**, except that it does *not* contain organelles. Recently, biologists have discovered that prokaryotic cells have a complex and functional **cytoskeleton** similar to that seen in eukaryotic cells.² The cytoskeleton helps prokaryotic cells divide and helps the cell maintain its plump, round shape. As is the case in eukaryotic cells, the cytoskeleton is the framework along which particles in the cell, including proteins, ribosomes, and small rings of DNA called plasmids, move around.
4. **Cell Membrane or Plasma Membrane** - Surrounds the cell's cytoplasm and regulates the flow of substances in and out of the cell. Prokaryotic cells can have multiple plasma membranes. Prokaryotes known as "gram-negative bacteria," for example, often have two plasma membranes with a space between them known as the periplasm. Just inside the cell wall, the plasma membrane is a selective barrier which regulates the passage of materials to from the cell. It is through this membrane that a cell must exchange food molecules, gases and other vital ingredients. Composed of phospholipid and protein membranes form thin, flexible, self-sealing, highly selective barriers between the inside of the cell and the outside world. As in all cells, the plasma membrane in prokaryotic cells is responsible for controlling what gets into and out of the cell. A series of proteins stuck in the membrane (poor fellas) also aid prokaryotic cells in communicating with the surrounding environment. Among other things, this communication can include sending and receiving chemical signals from other bacteria and interacting with the cells of eukaryotic organisms during the process of **infection**. Infection is the kind of thing that you *don't* want prokaryotes doing to you. Keep in mind that the plasma membrane is universal to *all* cells, prokaryotic and eukaryotic. Because this cellular component is so important and so common, it is addressed in great detail in its own In Depth subsection.
The genetic information on the plasmids is transferrable between cells, allowing prokaryotes to share such abilities as antibiotic resistance. Humans have discovered

that prokaryotic plasmids can be genetically engineered. Today, they are isolated, changed to carry other interesting information and then reintroduced into new cells. In this way unique and usefull little bacterial factories can be designed, created and put to work.

5. **Fimbriae (pili)** - Hair-like structures on the surface of the cell that attach to other bacterial cells. Shorter pili called fimbriae help bacteria attach to surfaces. Fimbriae are responsible for attachment of bacteria to specific receptors of human cell (adherence). There are special types of pili called (sex pili) involved in conjunction.
6. **Flagella** - Long, whip-like protrusion that aids in cellular locomotion. Flagella are organelles for cellular mobility. The bacterial flagellum stretches from cytoplasm through the cell membrane(s) and extrudes through the cell wall. They are long and thick thread-like appendages, protein in nature. Are most commonly found in bacteria cells but are found in animal cells as well. These are strands of protein that pass though the outer surface of the cell body either either singly or in tufts. Energy provided by the plasma membrane rotates the flagellum by means of a unique rotating 'joint' and this in turn moves the bacterium through its liquid world. Prokaryotic flagella are very different from similar looking structures used by eukaryotic cells.
7. **Ribosomes** - Cell structures responsible for protein production. **Prokaryotic ribosomes** are smaller and have a slightly different shape and composition than those found in eukaryotic cells. Bacterial ribosomes, for instance, have about half of the amount of **ribosomal RNA (rRNA)** and one third fewer **ribosomal proteins** (53 vs. ~83) than eukaryotic ribosomes have.³ Despite these differences, the function of the prokaryotic ribosome is virtually identical to the eukaryotic version. Just like in eukaryotic cells, prokaryotic ribosomes build proteins by translating messages sent from DNA.
8. **Plasmids** - Gene carrying, circular DNA structures that are not involved in reproduction.
9. **Nucleiod Region** - Area of the cytoplasm that contains the single bacterial DNA molecule. All prokaryotic cells contain large quantities of **genetic material** in the form of **DNA** and **RNA**. Because prokaryotic cells, by definition, do *not* have a nucleus, the single large circular strand of DNA containing most of the genes needed for cell growth, survival, and reproduction is found in the cytoplasm. The DNA tends to look like a mess of string in the middle of the cell:

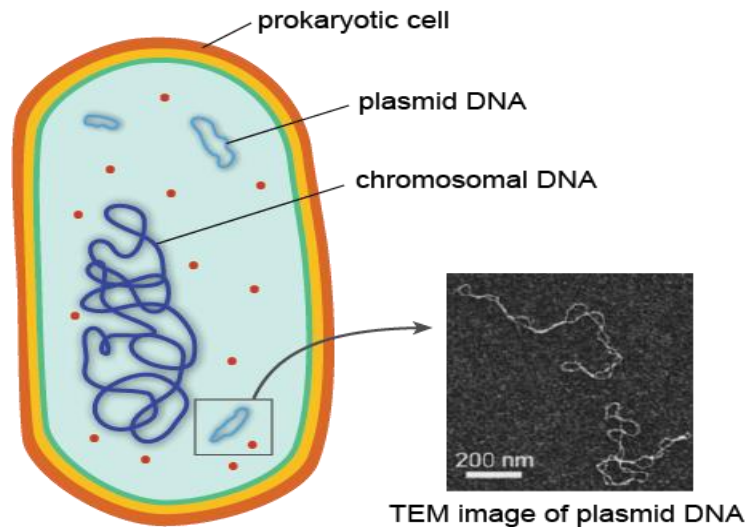

Figure 1.4. Transmission electron micrograph image (www.ncbi.nlm.nih.gov)

Usually, the DNA is spread throughout the entire cell, where it is readily accessible to be transcribed into messenger RNA (mRNA) that is immediately translated by ribosomes into protein. Sometimes, when biologists prepare prokaryotic cells for viewing under a microscope, the DNA will condense in one part of the cell producing a darkened area called a nucleoid (<http://www.shmoop.com/biology-cells/prokaryotic-cells.html>).

As in eukaryotic cells, the prokaryotic chromosome is intimately associated with special proteins involved in maintaining the chromosomal structure and regulating gene expression. In addition to a single large piece of chromosomal DNA, many prokaryotic cells also contain small pieces of DNA called plasmids. These circular rings of DNA are replicated independently of the chromosome and can be transferred from one prokaryotic cell to another through pili, which are small projections of the cell membrane that can form physical channels with the pili of adjacent cells.

The transfer of plasmids between one cell and another is often referred to as "bacterial sex." Sounds dirty. The genes for antibiotic resistance, or the gradual ineffectiveness of antibiotics in populations, are often carried on plasmids. If these plasmids get transferred from resistant cells to nonresistant cells, bacterial infection in populations can become much harder to control. For example, it was recently learned that the superbug MRSA, or multidrug-resistant *Staphylococcus aureus*, received some of its drug-resistance genes on plasmids.

Prokaryotic cells are often viewed as "simpler" or "less complex" than eukaryotic cells. In some ways, this is true: prokaryotic cells usually have fewer visible structures, and the structures they do have are smaller than those seen in eukaryotic cells. Don't be fooled, however, into thinking that just because prokaryotic cells seem "simple" that they are somehow inferior to or lower than eukaryotic cells and organisms. Making this assumption can get you into some serious trouble.

Biologists are now learning that bacteria are able to communicate and collaborate with one another on a level of complexity that rivals any communication system ever developed by humans. Prokaryotes showed you, Facebook and Twitter. In addition, some Archaeal

cells are able to thrive in environments so hostile that no eukaryotic cell or organism would survive for more than a few seconds.

Prokaryotic cells are also able to pull off stuff that eukaryotic cells could only dream of, in part *because* of their increased simplicity. Being bigger and more complex is not always better. These cells and organisms are just as adapted to their local conditions as any eukaryote, and in that sense, are just as “evolved” as any other living organism on Earth.

Reproduction in prokaryotic cells is by binary fission; a process of growth, enlargement and division. The DNA molecule of the cell is accurately duplicated and the two copies separated from each other by movement of the cell membrane to which they are attached. The cell then divides into two smaller but identical cells and each begins its own independent existence.



Figure 1.5. Reproduction in prokaryotic cells is by binary fission
(www.brooklyn.cuny.edu/bc/ahp/LAD/C5/C5_Prokary.html)

B. Eukaryotic Cells

Eukaryotes are organisms whose cells are organized into complex structures by internal membranes and a cytoskeleton. The most characteristic membrane bound structure is the nucleus. This feature gives them their name, (also spelled "eucaryote,") which comes from the Greek εὖ, meaning good/true, and κάρυον, meaning nut, referring to the nucleus. Animals, plants, fungi, and protists are eukaryotes. Eukaryotes is wrapped by a nuclear membrane so that it does not mix with the cytoplasm. The most striking difference from prokaryotic cells is the true nucleus that encloses most of the cell's DNA so that the DNA is stored in a different compartment of the cytoplasm.

To better understand the models shown below eukaryotic cells. in the form of three-dimensional and two- dimensional. Parts of the cell are described below in particular will be discussed further in this learning activity. While the particulars of the cell membrane will be discussed in more detail in Chapter 3.

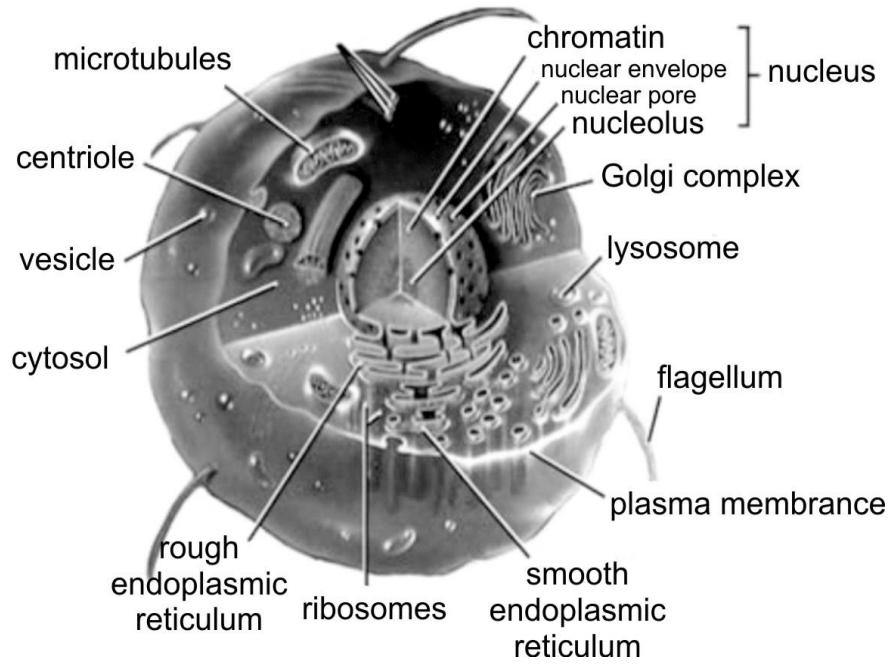

Figure 1.6. Eukaryotic Cells models in three dimensions (animal cells).

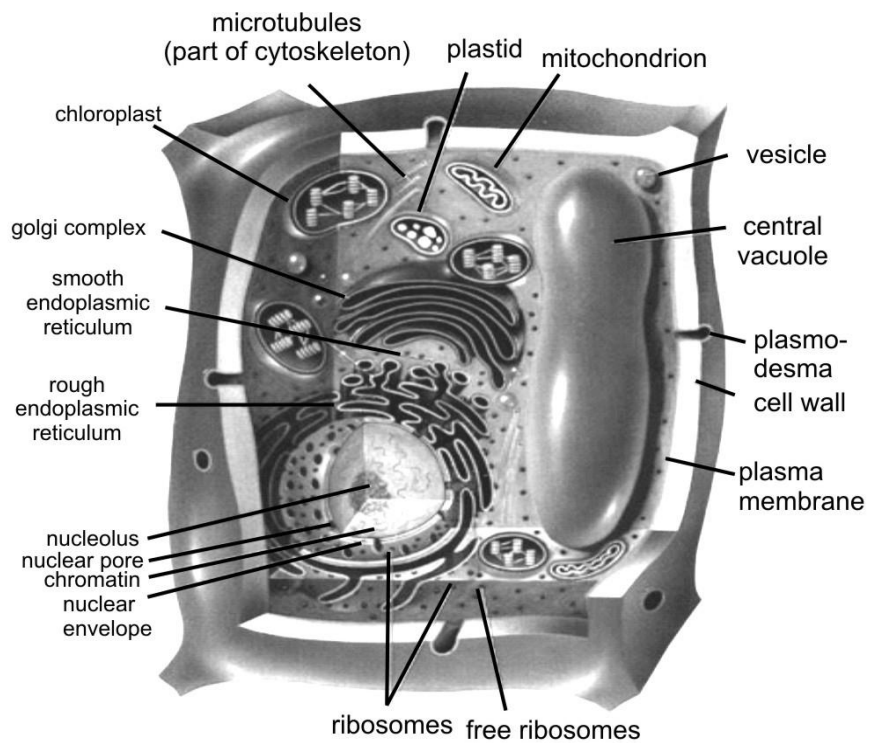

Figure 1.7. Eukaryotic cell model in two dimensions.

Table 1.1. Comparison of features of prokaryotic and eukaryotic cells
(http://en.wikipedia.org/wiki/Cell_biology)

	Prokaryotes	Eukaryotes
Typical organisms	bacteria, archaea	protists, fungi, plants, animals
Typical size	~ 1–5 $\mu\text{m}^{[9]}$	~ 10–100 $\mu\text{m}^{[9]}$
Type of nucleus	nucleoid region; no true nucleus	true nucleus with double membrane
DNA	circular (usually)	linear molecules (chromosomes) with histone proteins
RNA/protein synthesis	coupled in the cytoplasm	RNA synthesis in the nucleus protein synthesis in the cytoplasm
Ribosomes	50S and 30S	60S and 40S
Cytoplasmic structure	very few structures	highly structured by endomembranes and a cytoskeleton
Cell movement	flagella made of flagellin	flagella and cilia containing microtubules; lamellipodia and filopodia containing actin
Mitochondria	None	one to several thousand (though some lack mitochondria)
Chloroplasts	None	in algae and plants
Organization	usually single cells	single cells, colonies, higher multicellular organisms with specialized cells
Cell division	Binary fission (simple division)	Mitosis (fission or budding) Meiosis

In addition we can also see the difference between plant and animal cells by observing the models listed below.

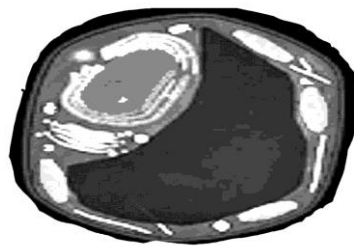

Figure 1.8. Plant cells (<http://www.cellsalive.com/cells/>.)

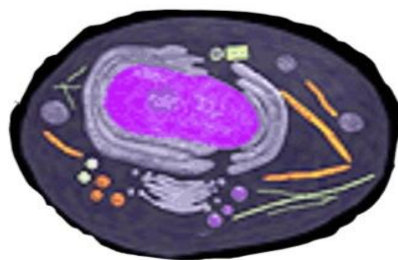

Figure 1.9. Animal cells (<http://www.cellsalive.com/cells/>)

A cell structure is illustrated in Figure 1.9. Plant cells and animal cells Figure 1.6. which describes the shape of various types of cells.

If we look at the plants and animals have a very big difference. where plants can not move with such active animals. This is because the shape of plant cells are rigid so it is not flexible. in contrast to animal cells that are flexible and can change shape. Aside from the shape. the differences plant cells and animal cells can also be differentiated from the following:

Table 1.2. Differences as plant and animal cells

Plant Cells	Animal Cells
1. Plant cells Animal cells larger than	1. Animal cells are smaller than plant cell
2. Do not have the lysosome	2. Not having plastids
3. Do not have the centrosome	3. Do not have cell walls
4. Have a cell wall and cell membrane	4. Having lysosomes
5. Generally have plastids	5. Having centrosome
6. Have a fixed shape	6. Have no fixed shape
7. Has a large vacuole size. Lot	7. Not having vakuala (although there also have vacuoles but small size)

There are two main parts of the cell. namely: core and its contents are often called nucleoplasm. and the remaining part is called the cytoplasm. Nucleus and cytoplasm were surrounded by a membrane. as well as smaller parts like mithokhondria and Golgi bodies. Broadly speaking, the structure and function of each cell component is as follows

1. Nuclei

The cell nucleus consists of a nuclear membrane, nucleoplasm, nucleolus and chromosomes. The nuclear membrane is a double membrane that has four phospholipid layers and large pores through which materials pass. It also contains a viscous liquid known as the nucleoplasm. The nucleus is the most prominent organelle in the cell. This small organ is separated from the cytoplasm (plasma cells) by wrapping which consists of two membranes. the inner membrane and outer membrane. The nucleus contains the genetic material that is Deoxy Ribonucleic Acid (ADN) is encased in a nuclear membrane. All chromosomal DNA is stored in the nucleus. packed in chromatin fibers thanks to its alliance with the histone proteins that same mass. Fill nucleus communicates with the cytosol through the holes in the wrapper called pores nucleus. Nucleoli in the nucleus there is a place for ribosoma producing cells.

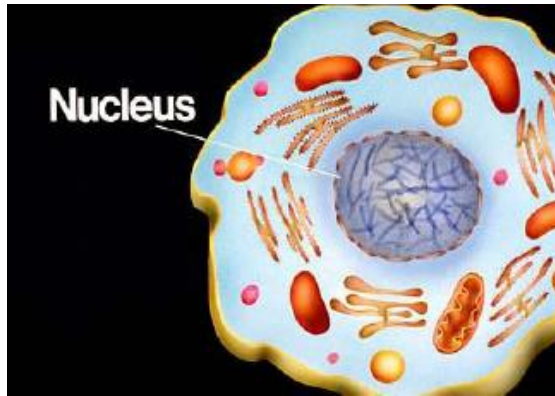

Figure 1.10. The structure of the nucleus (micro.magnet.fsu.edu).

2. Plasma membrane

Cell membranes are found in animal cells whereas cell walls are found in plant cells. Cell walls and membranes have similar functions. Like a city perimeter, cell membranes surround the cell and have the ability to regulate entrance and exit of substances, thereby maintaining internal balance. These membranes also protect the inner cell from outside forces. Cell walls, as the city analogy implies, are much stronger than cell membranes and protect cells from lysing (exploding) in extremely hypotonic (diluted) solutions. Membrane is very thin and is selectively permeable to the size of 7.5-10 nm. The plasma membrane is a lipid double layer (bilayer) is the molecular structure of two layers. Lipids are important are glycolipids and phospholipids and little chance of containing cholesterol. The structure of the plasma membrane of cells such support to be able to take advantage of changes in ion permeability control at the plasma membrane of cells for communication purposes. In addition, it also serves as a protective organelles within the cell.

Different from the plasma membrane of eukaryotic cells, the plasma membrane in eukaryotic cells can develop specialized capabilities or organelles. In eukaryotic cells, which do not have mitochondria. the plasma membrane is also in charge of implementing energy metabolism. The difference is what causes that in eukaryotic cells. the plasma membrane is not formed mesosom.

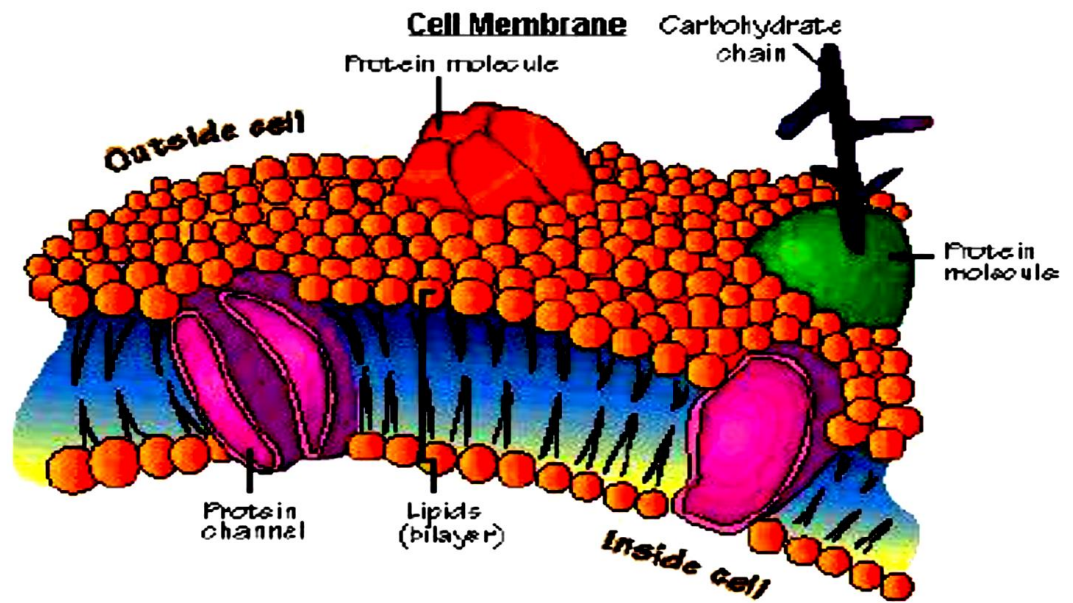

Figure 1.11. Plasma Membrane

3. The cell organelles

Organelles are parts of the cell which are adapted and/or specialized for carrying out one or more vital functions, analogous to the organs of the human body (such as the heart, lung, and kidney, with each organ performing a different function). Both eukaryotic and prokaryotic cells have organelles, but prokaryotic organelles are generally simpler and are not membrane-bound.

There are several types of organelles in a cell. Some (such as the nucleus and golgi apparatus) are typically solitary, while others (such as mitochondria, chloroplasts, peroxisomes and lysosomes) can be numerous (hundreds to thousands). The cytosol is the gelatinous fluid that fills the cell and surrounds the organelles.

The number of organelles in the cytoplasm of eukaryotic cells are more complex than prokaryotic cells. The organelles eg mitochondria. endoplasmic reticulum. nucleus. ribosomes. microtubules. and others.

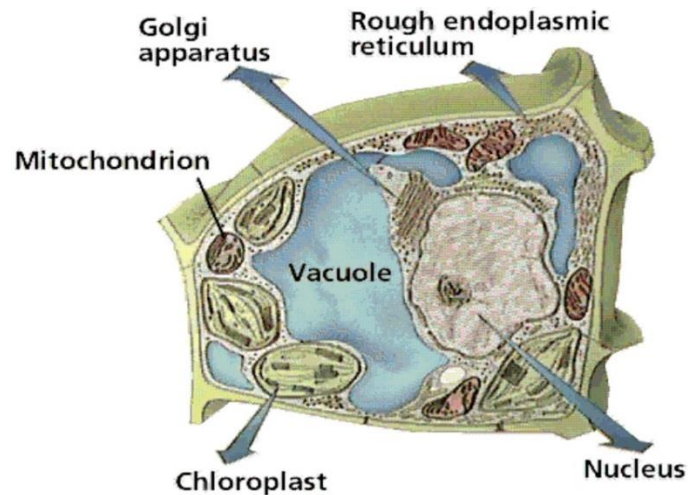

Figure 1.12. Organelles Cell.

a. Endoplasmic Reticulum (Endoplasmic reticulum)

There are two types of endoplasmic reticulum (ER) – **Smooth ER** and **Rough ER**. This extensive network makes up approximately one half of all membranous tissue of the cell and is the site of membrane and protein synthesis. The ER system is much like a road system along which industry can be found. Goods are manufactured and shipped to needed areas via the road system. Rough ER is named for the presence of ribosomes along its membrane and is the source of proteins. Smooth ER lacks ribosomes and is responsible for lipid synthesis and processes a variety of metabolic processes such as drug detoxification.

Endoplasmic reticulum (ER) membrane is a maze so much so that it covers more than half the total membrane in eukaryotic cells. The word 'endoplasmic' means within the cytoplasm and reticulum derived from the Latin word which means the network. RE consists of a network of tubules and membrane bubbles called sistical or lumen. ER membrane separates the internal space, namely the space sistical from the cytosol. And because the ER membrane continuous with the nuclear envelope, the room between the two membrane sheath was continuous with the RE sistical room.

In general, the RE has the following functions;

- 1) Performers synthetic metabolic activity, because it contains a variety of enzymes.
- 2) denaturation and elongation of fatty acids.
- 3) Providing a wide surface for enzymatic reactions.
- 4) An ultra- structural skeleton that provides the mechanical strength of the cell, the cytoplasm koloidalnya matrix.
- 5) As a place of exchange of molecules through a process of osmosis, diffusion and active transport to the ER membrane and eksosistosis.
- 6) Establish a new core wrap on cell division.
- 7) cell protection function for the ER membrane is able to eliminate the toxic effects of substances through the detoxification process.

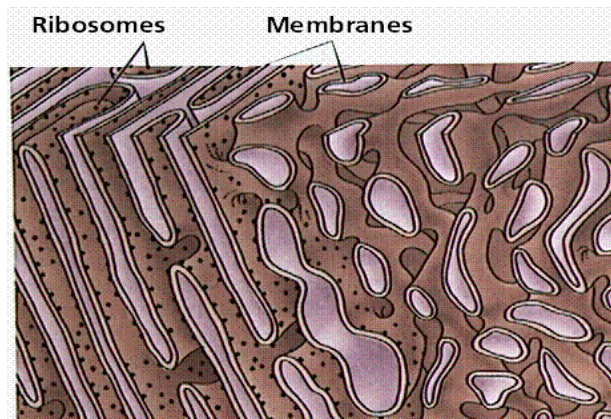

The Science of Biology. 4th Edition. by Sinauer Associates. www.sinauer.com) and WH Freeman (www.whfreeman.com).

Figure 1.13. Endoplasmic reticulum.

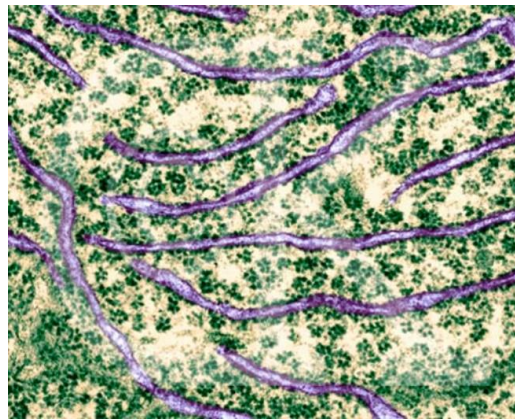

(www.DennisKunkel.com.)

Figure 1.14. Photos using Scanning Electron Microscopy of reticulum endoplasmic and the ribosomes. (TEM x 61.560).

b. Golgi apparatus (Golgi Apparatus/Golgi Complexes)

Like a post office, the golgi apparatus is used for shipping those goods created by the ER and ribosomes to the rest of cell. These organelles were first discovered by Camilio Golgi. a scientist from Italy. Golgi apparatus is common on plant and animal cells. In animal cells are 10-20 Golgi apparatus. As with plants that have hundreds of Golgi bodies in each cell. Golgi apparatus has a length of about 1-3 μm and a height of about 0.5 μm . Golgi apparatus including cell vacuolar system and there are no ribosomes. On the polar structure of cells. single Golgi apparatus. large and occupies at the core and at the poles of the cell. for example in the glandular cells eksokim prankeas. In liver cells in a cell. there are about 50 that form the Golgi complex varies between cells with one another. Golgi apparatus consists of a group of membrane bounded flattened bag called saccula. Near saccula contained secretory vesicles form spherical bubbles. The Golgi apparatus in plants called diktiosom. In the manufacture of polysaccharide diktiosom occurs in the form of cellulose that is used as the building blocks of the cell wall.

Based on morphological observations and in situ cytochemistry and biochemical studies indicate that the Golgi apparatus is involved in a large number of cell activities include assembly of proteins and lipids high carbohydrate or better known as glycosylation process. recovery of the cell membrane. and secretion.

In general, the function of the Golgi apparatus. among others:

- 1) forming cell walls in plants
- 2) produces lysosomes
- 3) forming acrosome in spermatozoa containing enzymes to break down the cell wall of the egg.
- 4) Places such as mucus synthesis of polysaccharides. cellulose. hemicellulose. and pectin (constituent of plant cell walls).
- 5) Forming the plasma membrane.
- 6) Forming bag to wrap secretion of substances to be issued a cell. such as proteins. glycoproteins. carbohydrates. and fats.

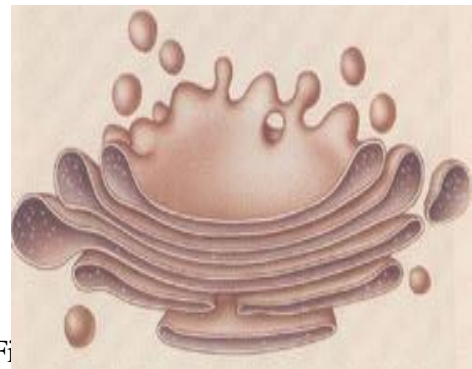

Fi

Golgi Complex

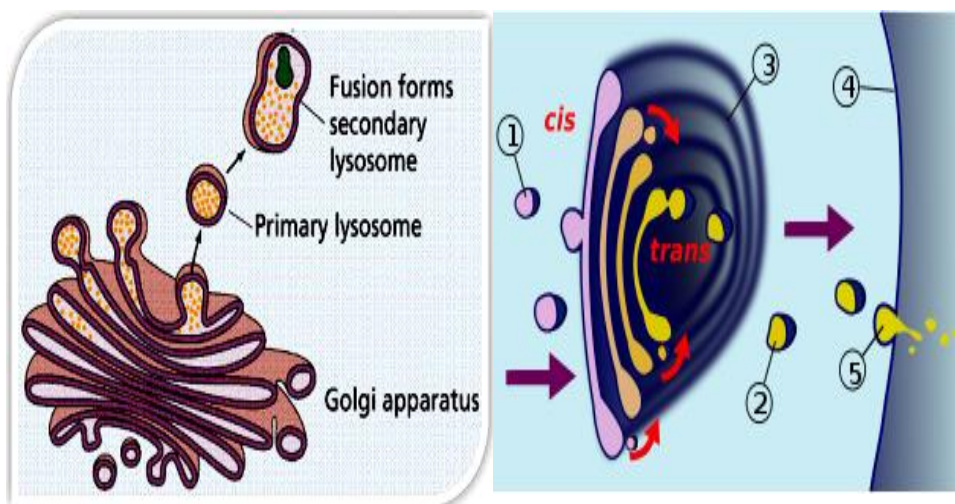

Figure 1.16. Golgi apparatus.

c. Mitochondria

Mitochondria are found in both plant and animal cells and is the site of cellular respiration. Through this process that will be covered in the Photosynthesis and Respiration lab **ATP** is created which is used for energy by the cell. The size and shape of mitochondria, as well as the numbers in the cells, tissues and varies according to the physiological state of the cell by. By using visible light microscopy oval mitochondria, but mitochondria can also dumbbell-shaped, spherical, or racket, with a diameter of 0.5-1.0 and length up to 7 μm . Due to the very small size of new structures can be viewed using an electron microscope. Mitochondria contain small amounts of DNA, RNA and ribosomes. Mitochondrial DNA provide the password for the synthesis of certain specific proteins on the inner membrane. Most mitochondrial proteins are encoded by nuclear DNA and synthesized by ribosomes are present in the cytosol or in the endoplasmic reticulum. This shows that there is a connection / transfer of information from DNA to the nucleus of mitochondrial later emerged from DNA found in the mitochondria themselves.

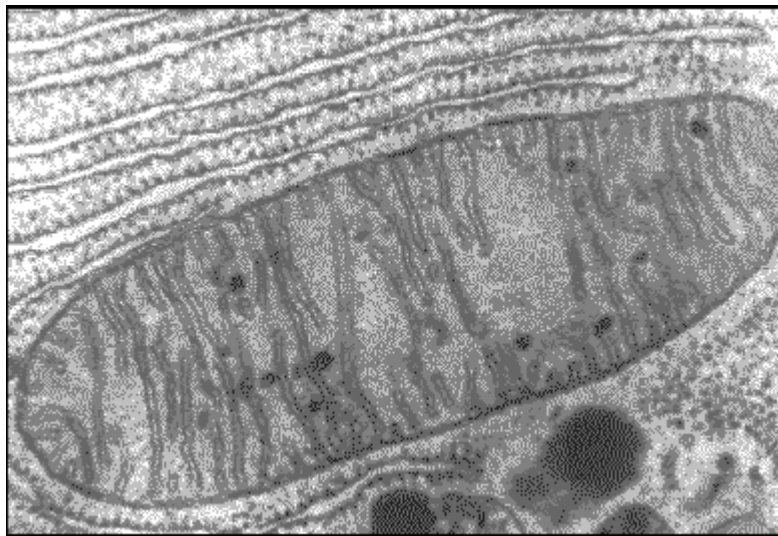

Figure 1.17. Electron microscope picture of a mitochondria

d. Chloroplasts

Place photosynthesis is high organ subcellular structure called chloroplasts. The result of chemical changes in photosynthesis are CO_2 and H_2O into carbohydrates. Carbohydrates are stored and produced as a result of photosynthesis can be seen as grains of starch.

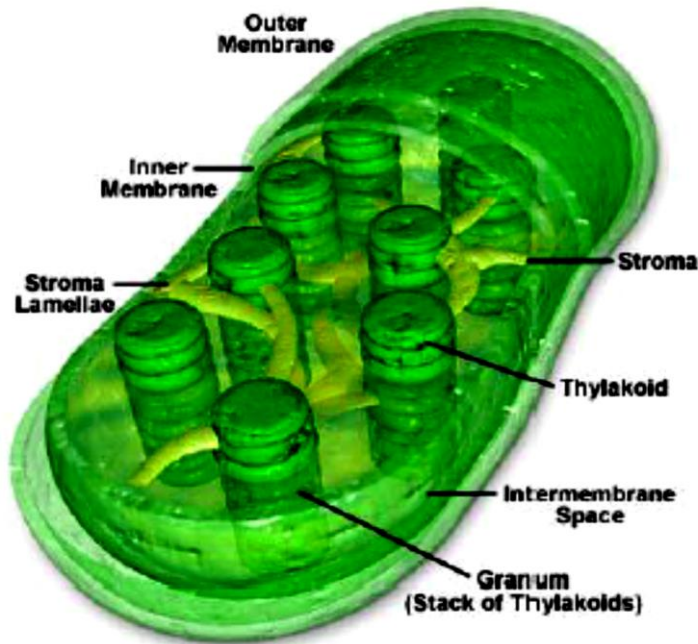

Figure 1.18. Chloroplast

4. In the membrane

Eukaryotic cells typically have a much larger volume than prokaryotic cells, typically a thousand times or more. Material or any material of cells it contains many times more. For example that the human body cells contain DNA that is a thousand times more than that of bacteria.

Membranes in various organelles such as the mitochondria membrane, vacuole membrane (in plant cells), the Golgi apparatus and the other is the venue for important reactions. Due to the addition of the cell volume must be balanced with the addition of the cell surface area by maintaining the ratio of surface area to volume ratio. This explains why all eukaryotic cells have many characteristics of the basic form and complexity of the membrane in the form of:

- a. In the endoplasmic reticulum membrane that forms a maze -like compartments.
- b. Golgi membranes in the body that make up the pile of bags deflated play a role in the conversion of product molecules from the endoplasmic reticulum.
- c. Lysosomal membrane of cells that contains digestive enzymes.
- d. Peroxisome membrane wrapping where the formation and decomposition of H_2O_2 are reactive and dangerous during the oxidation of a variety of molecules by O_2 .
- e. Vacuole membrane (tonoplas) in plant cells that form small bubbles and large cavity filled with fluid.

With the cell structure located next to the cell, can provide adequate surface area corresponding to the large volume, namely that between membrane-bound compartments within the cell and outside the cell environment occurs an exchange

mechanisms (transport) is relentless. The mechanism of endocytosis and exocytosis is, which only occurs in eukaryotic cells.

In endocytosis, the parts forming the outer membrane curvature toward the later rounded and separated into bubbles of membrane-bound cytoplasm and contain substances that come from outside of cells and molecules that have been previously absorbed on the surface of cells.

Exocytosis is the reverse process of endocytosis. In this case, bubbles encased in a cell membrane, referring to the plasma membrane and release their contents into the outer environment. That way, the membranes around the compartment which is located deep within the cell to function effectively increase the cell surface area for the exchange of materials from outside.

5. Cytoskeleton

The cytoskeleton acts to organize and maintain the cell's shape; anchors organelles in place; helps during endocytosis, the uptake of external materials by a cell, and cytokinesis, the separation of daughter cells after cell division; and moves parts of the cell in processes of growth and mobility. The eukaryotic cytoskeleton is composed of microfilaments, intermediate filaments and microtubules. There are a great number of proteins associated with them, each controlling a cell's structure by directing, bundling, and aligning filaments. The prokaryotic cytoskeleton is less well-studied but is involved in the maintenance of cell shape, polarity and cytokinesis.

The cytoskeleton represents the cell's skeleton. Like the bony skeletons that give us stability, the cytoskeleton gives our cells shape, strength, and the ability to move, but it does much more than that. The cytoskeleton is made up of three types of fibers that constantly shrink and grow to meet the needs of the cell: microtubules, microfilaments, and actin filaments. Each type of fiber looks, feels, and functions differently. Microtubules consists of a strong protein called tubulin and they are the 'heavy lifters' of the cytoskeleton. They do the tough physical labor of separating duplicate chromosomes when cells copy themselves and serve as sturdy railway tracks on which countless molecules and materials shuttle to and fro. They also hold the ER and Golgi neatly in stacks and form the main component of flagella and cilia.

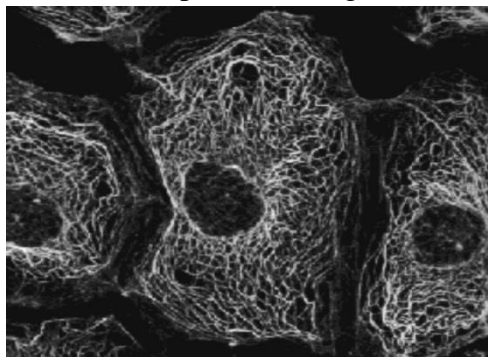

Figure 1.19. Cytoskeleton (www.sinauer.com).

All eukaryotic cells are equipped with a cell skeleton (cytoskeleton) that functions give it shape, motility and ability to regulate the organelles and organelles

move from one part of the cell to another. This is caused by the growing size of a cell. the more complicated and more specialized structures in it. Thus the greater the necessity to keep these structures remain as they are and adjust their movements.

Cell skeleton is composed of a network of protein filaments. Three of the most important of which are actin filaments (also called microfilaments), intermediate filaments, and Microtubules.

Microfilaments are long thin fibers with a diameter of 5-6 nm. Composed of a protein called actin. Many microfilaments form a collection or network at various places in the cell. That coupled with the presence of cell motion. When an animal cell divides into two, for example, a beam forming microfilaments and separates the two daughter cells.

In many cells, the cytoplasm moved and this phenomenon called cytoplasmic flow. Motion depends on the presence of microfilaments. Microfilaments is also a feature that is important in the cell move and change shape. This does not just apply to the free movement of independent cells as well as amoeba, but also in most animal cells during embryo formation.

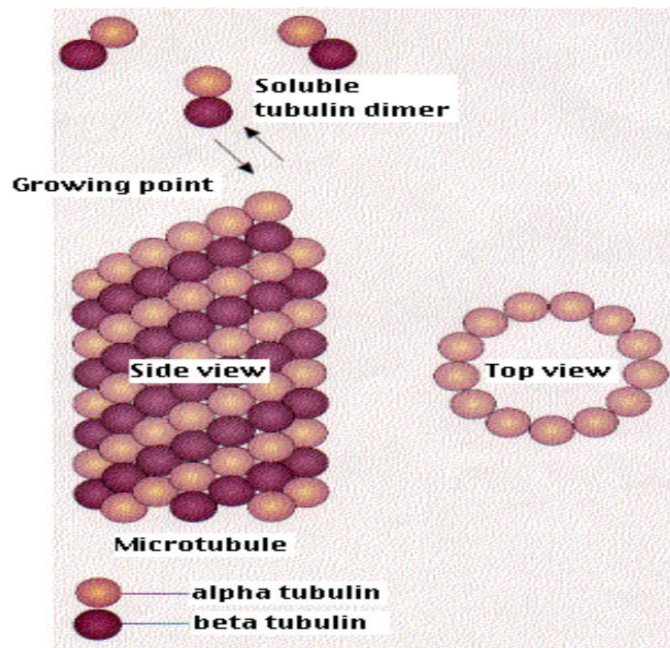

Figure 1.20. Scheme of cytoskeleton.

Cytoplasmic intermediate filament is a long fiber with a diameter of about 10 nm. Called intermediate because its diameter is larger than the diameter of microfilaments (6 nm) and smaller than the diameter of microtubules (25 nm) and the filaments 'thick' (15 nm) in skeletal muscle fibers. Intermediate filaments composed of fibrous protein molecules. Intermedia is a hollow filament yarn consisting of five protofilament, parallel to one another and form a circle. Intermediate filaments found in many cells that often get mechanical stresses, such as cell epithelium, the axons of nerve cells or smooth muscle cells.

Cylindrical microtubule protein is found in most animal and plant cells. There are two kinds of β -tubulin and α -tubulin. Each with a molecular weight of about 55,000 daltons. Microtubules also play a very important role in cell division. Successful cell division requires proper distribution of chromosomes into each daughter cell. Each chromosome moves to the goal ended in a bundle of microtubules. Microtubules are also used in the formation of centrioles, basal bodies and flagella.

There are two groups of microtubules: 1) microtubules are stabilized microtubules can be preserved with a fixative solution of any sort. for example: OsO₄, MnO₄, or aldehydes at any temperature. 2) microtubules are labile microtubules can be preserved only by the solution of Figure 1.16. Aldehyde fixative microtubules and at about 4 ° C.

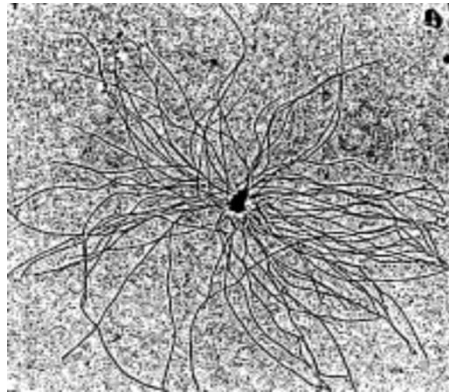

Figure 1.21a. Microtubules.

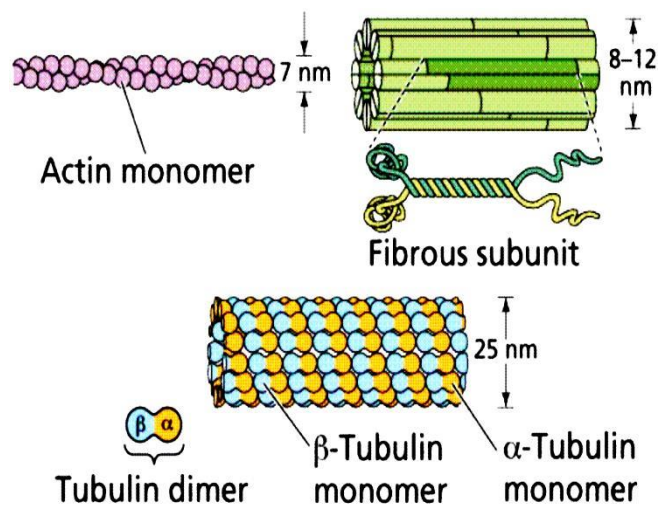

Figure 1.16b. Microtubules parts.

Table 1.3. Comparison between the properties of microtubules, microfilaments and intermediate filaments.

The nature / Signs	Microtubule	Intermedia filaments	Microfilaments
Structure	Hollow with wall consists of 13 protofilamen	Hollow with walls consisting of 4-5 rotofilamen	Incompressible (solid) consists of polymeric actin (Actin - F)
Midline (nm)	24	10	7
Unity monomer	α and β tubulin	5 kinds of proteins	Actin -G
ATP-ase activity	Located in dinein	----	---
function	The ability of the movement in eukaryotes. Kromosoma movement. Intra- cell material movement Maintaining cell shape.	combine unity contraction in the muscle cells	Berperan dalam kontraksi otot Plays a role in muscle contraction changes in cell shape of protoplasm sitokenesis.

EXERCISE

To improve your understanding of the material above, do the exercises below!

- 1) Explain the four main parts of a prokaryotic cell structure and function with each one!
- 2) Explain briefly the difference between animal cells and plant cells ?
- 3) Explain how the transport mechanism in eukaryotic cells ?
- 4) Explain briefly how the function of the Golgi apparatus (Golgi apparatus) in a cell !
- 5) Briefly describe the difference between stable microtubules and microtubule instability!

Instructions to Answer Exercise

If you have difficulty in answering the questions above consider the answers below as a reference.

- 1) In general, prokaryotic cells have four main parts to the structure and function of each part is as follows: (1) the cell wall, which consists of a variety of organic materials, such as cellulose, hemicellulose, and chitin, its function is to give a particular shape to the cells, as a powerful protector, also to regulate the entry and exit of chemicals into the cell. (2) the plasma membrane is wrapping the protoplasm and is often referred to plasmalema or hyaline layer, composed of proteins and lipids. In certain places the plasma membrane folds and form a building called the mesosoma. Mesosoma often

called kondrioid which acts as a regulator for the division and photosynthesis photosynthetic bacteria. (3) is often called the protoplasm or cytoplasm of plasma cells. is a colloid that contains a lot of carbohydrates. proteins. enzymes. sulfur. calcium carbonate and volutin which contains ribonucleic acid (ARN) and easy to suck the color is alkaline. (4) the flagella. the structure in the form of a rope coming out of the surface of the cell. the cell is able to move to move. this tool is derived from the basal granules found in the cytoplasm. in the middle there is a filament consisting of compounds protein called flagelin.

- 2) Plants and animals have a very big difference. where plants can not move with such active animals. This is because the shape of plant cells are rigid so it is not flexible. in contrast to animal cells that are flexible and can change shape. Aside from the shape. the differences plant cells and animal cells can also be differentiated from the following:

Plant Cells	Animal Cells
1. Plant cells Animal cells larger than	8. Animal cells are smaller than plant cell
2. Do not have the lysosome	9. Not having plastids
3. Do not have the centrosome	10. Do not have cell walls
4. Have a cell wall and cell membrane	11. Having lysosomes
5. Generally have plastids	12. Having centrosome
6. Have a fixed shape	13. Have no fixed shape
7. Has a large vacuole size. Lot	14. Not having vakuala (although there also have vacuoles but small size)

- 3) The transport mechanism in eukaryotic cells is endocytosis and exocytosis. In endocytosis. the parts forming the outer membrane curvature toward the later rounded and separated into bubbles of membrane-bound cytoplasm and contain substances that come from outside of cells and molecules that have been previously absorbed on the surface of cells. While exocytosis is the reverse process of endocytosis. In this case. bubbles encased in a cell membrane. fused with the plasma membrane and release their contents into the outer environment. That way. the membranes around the compartment which is located deep within the cell to function effectively increase the cell surface area for the exchange of materials from outside.
- 4) Golgi apparatus is involved in a large number of cell activities include assembly of proteins and lipids high carbohydrate or better known as glycosylation process. recovery of the cell membrane. and secretion.

In general, the function of the Golgi apparatus. among others:

- a) forming cell walls in plants ;
- b) produces lysosomes ;
- c) forming the sperm acrosome contains enzymes to break down the cell wall of the egg.
- d) The synthesis of polysaccharides such as mucus. cellulose. hemicellulose. and pectin (constituent of plant cell walls).
- e) Establish the plasma membrane.

- f) Establish bag to wrap the secretion of substances to be issued a cell. such as proteins. glycoproteins. carbohydrates. and fats.
- 5) Stable microtubules. the microtubules can be preserved with a fixative solution of any sort. for example: OsO₄. MnO₄. or aldehydes at any temperature. Microtubules are labile microtubules can be preserved only by the aldehyde fixative solution and at about 4° C.

RESUME

The cell is the structural integrity. functional. and hereditary smallest of living creatures in the form of a small space bounded by membranes and contains a dense fluid. the cell is the basic unit of biology. Biogenesis theory states that all living cells come from cells that already exist. The concept was popular with *Omnis cellula e cellula*. Cells can be grouped into two major groups. namely prokaryotic cells (prokaryotic) and eukaryotic cells (eukaryotic).

Prokaryotic cells are cells that do not have nuclear membrane. this causes the nucleus mixed or hold a direct relationship with the cytoplasm. The size of prokaryotic cells is very small. ie 1-10 μm . Examples of prokaryotic cells is the mycoplasma. bacteria and algae blue. In general, prokaryotic cells have four main parts to that: the cell wall. plasma membrane. cytoplasm. and flagella.

Is a eukaryotic cell with a true nucleus. This cell is wrapped by a nuclear membrane so that it does not mix with the cytoplasm. There are two main parts of the cell. namely: core and its contents are often called nucleoplasm. and the remaining part is called the cytoplasm. Nucleus and cytoplasm were surrounded by a membrane. as well as smaller parts such as mitochondria and Golgi bodies.

CHAPTER 2 THE CELL MEMBRANE

Cell membranes (plasma membrane, plasmalemma) is a universal feature shared by all types of cells form the interface layer called the plasma membrane, which separates the cells with the environment outside the cell, especially for protecting the cell nucleus and survival system working in the cytoplasm. Cell membrane in the form of a thin membrane, also called the plasma membrane (plasmalema). Cell membrane thickness between 5-10 nm (1nm = 1.10^{-9} m). When the cell membrane was observed with a light microscope is not clear, but its existence can be proven at the time the cells undergo plasmolysis. The plasma membrane is very thin so it can only be visualized by electron microscopy. The plasma membrane is a layered arrangement with an irregular pattern and consist mainly of proteins and lipids. Membrane function can not be separated from the process of life. Plasma is a plasma membrane that limits the cell with its environment that are semipermeable.

The cell membrane is composed of protein molecules, a layer of fatty compounds (phospholipids), water, carbohydrates, and less cholesterol. Each layer of fatty compounds, composed of lipids and phosphate group. Lipid group of phospholipids is not like water (hydrophobic), while phosphate group is like water (hydrophilic). Gusus often called lipid tails and a phosphate group is called the head. Each phospholipid will be paired with each other to form a double layer (bilayer) of phospholipids opposite. Biochemical reactions in cell metabolism requires certain materials (eg nutrients, O_2) from outside the cell, in addition, it is also used to remove metabolic waste that is not useful (eg CO_2). The entry of materials into cells and to certain substances outside of the cell is regulated by a plasma membrane.

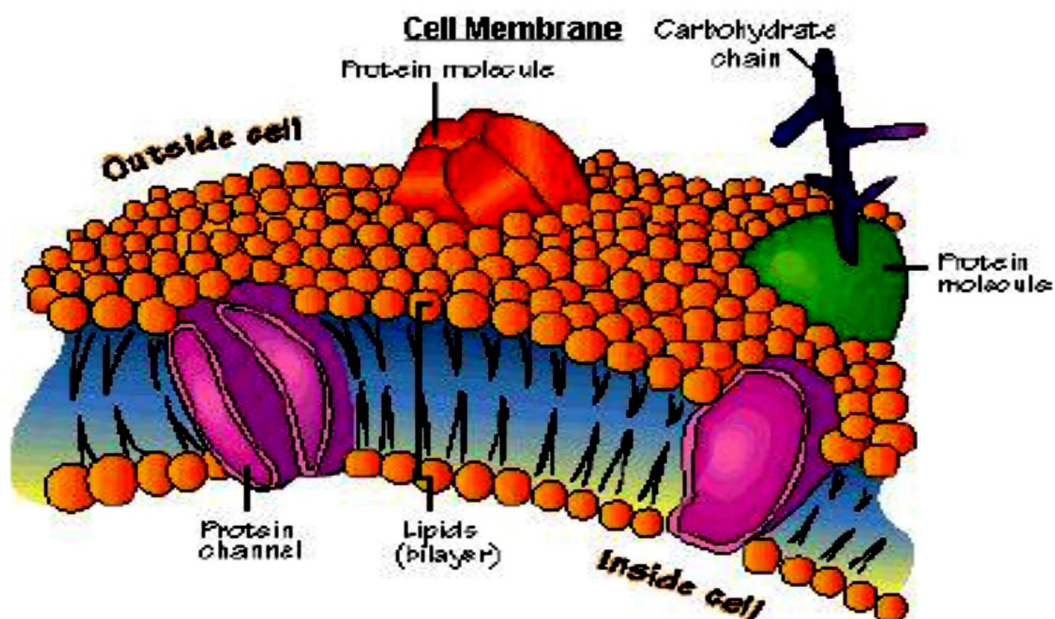

Figure 2.1. Plasma membrane.

Theories on the plasma membrane has been known since Overtoon found that the plasma membrane is composed of phospholipid molecules that form a series of layers. Phospholipids are compounds that are hydrophilic (in the head is a phosphate group) and hirofobik (the fatty acid tail area). Thus it can serve as an insulating layer because the water outside the protoplasm can not enter the cells.

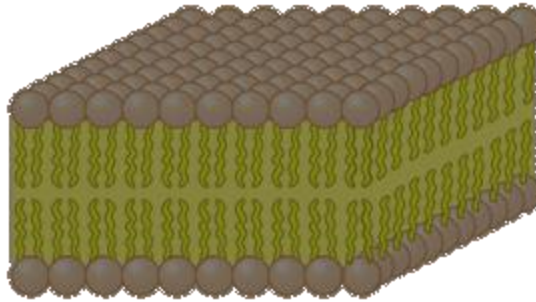

Figure 2.2. Model Overtoon plasma membrane.

In 1925, when E. Gorter and F. Grendel published the results of his research on the organization of lipids in the membrane of red blood cells. Their research was obtained from the blood of various mammals including dogs, sheep, rabbits, pigs Guinia, goats and humans. Gorter and Grendel concluded that the cell membrane is formed by bimolecular lipid sheets. They claimed that the polar end of one layer of lipid molecules facing outward (to the plasma environment) and the polar ends of the other lipid layer facing inwards. Then at the end of the hydrophobic nonpolar part will be facing each other. Goster and Grendel models can not explain how substances that are not soluble in fat can penetrate the membrane.

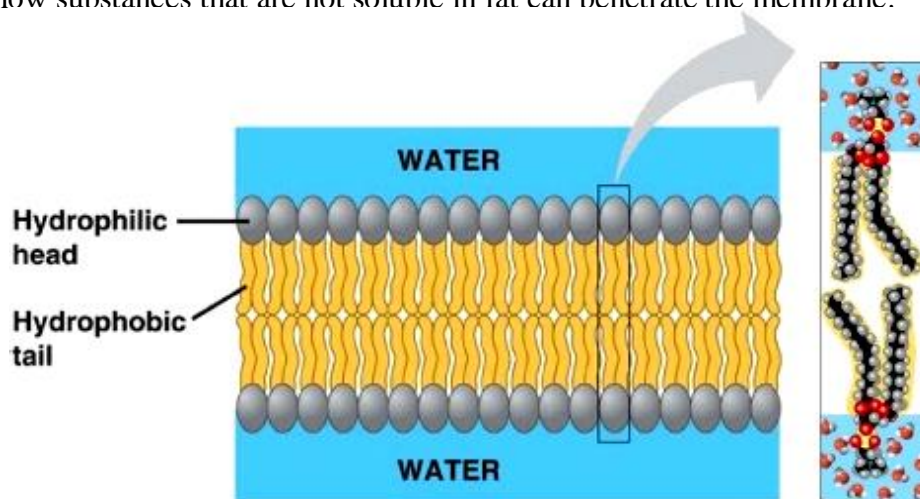

Figure 2.3. Model of the plasma membrane Goster & Grendel.

In 1938 Davson and Danielli suggested that the plasma membrane is composed of two layers of lipids, hydrophobic ends facing each other like arrangement of the micelles can dissolve and bind together with hydrophobic interactions. While the opposite end (the other

pole), facing outward, directly related to the protein layer and monomolekul. Davson and Danielli structure called a model cake sandwich.

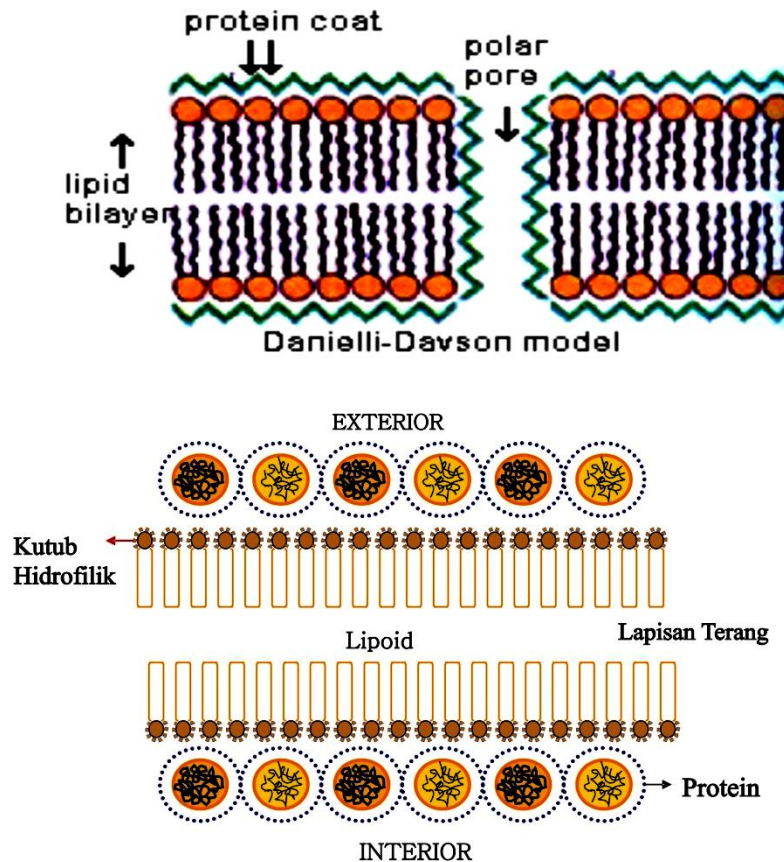

Figure 2.4. Model of the plasma membrane Cake Sandwich (Davson & Danielli).

In 1957 J.D. Robertson suggested that certain membrane with osmium tetroxide Trilaminar forming layer is characteristic. Trilaminar consists of two layers of parallel dark outside (osmiophilic) and a layer of light at the center (osmiobhic). Osmiophilic layer typically has a thickness of size 2.0 to 2.5 nm. According to Robertson dark outer layer parallel thought to be composed of protein and fat molecules are polar, while the bright layer in the central part consists of the non-polar molecules are fat. Later, in 1965, Robertson changed his mind. He considers that the outer layer of protein and fat are not polar but mucopolysaccharides and fat are polar.

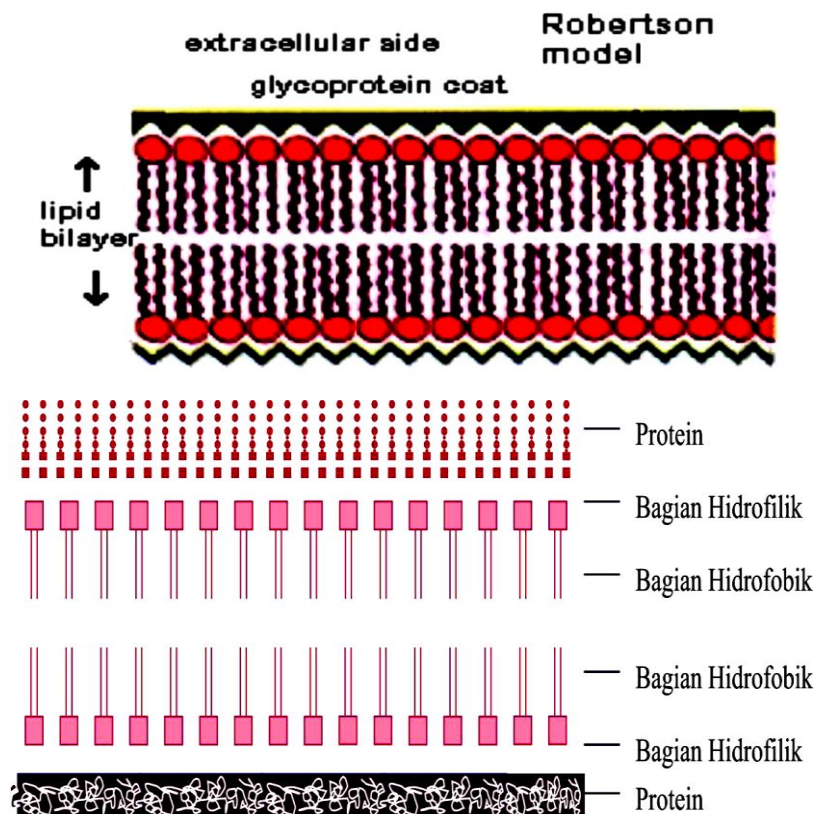

Figure 2.5. Plasma Membrane Model J. P. Robertson.

S.J. Singer and Nicolson, in 1972, proposed the fluid mosaic model of the plasmalemma. They propose a model basically describes that the solution of two-dimensional membrane is composed of lipids and globular proteins are targeted. The characteristics of this model is a large part of the whole molecule is composed of membrane phospholipids and glycolipids as bilayer . Bilayer holds a dual role: first, as an integral membrane protein solvent and secondly, as a barrier membrane and may be required for certain activities. Membrane proteins can freely diffuse laterally within the lipid matrix, unless there are special restrictions by the interaction, but not free to rotate from one side of the membrane to the other side. Fluid mosaic membrane model is the model membranes used at this time because it is able to answer the problem of traffic that passes through the membrane permeability substances. A small part of the typical membrane lipids interact with proteins.

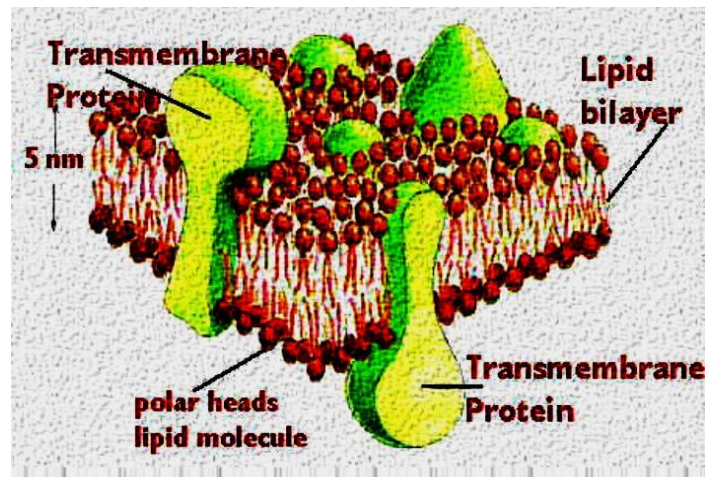

Figure 2.6. Fluid Mosaic Model.

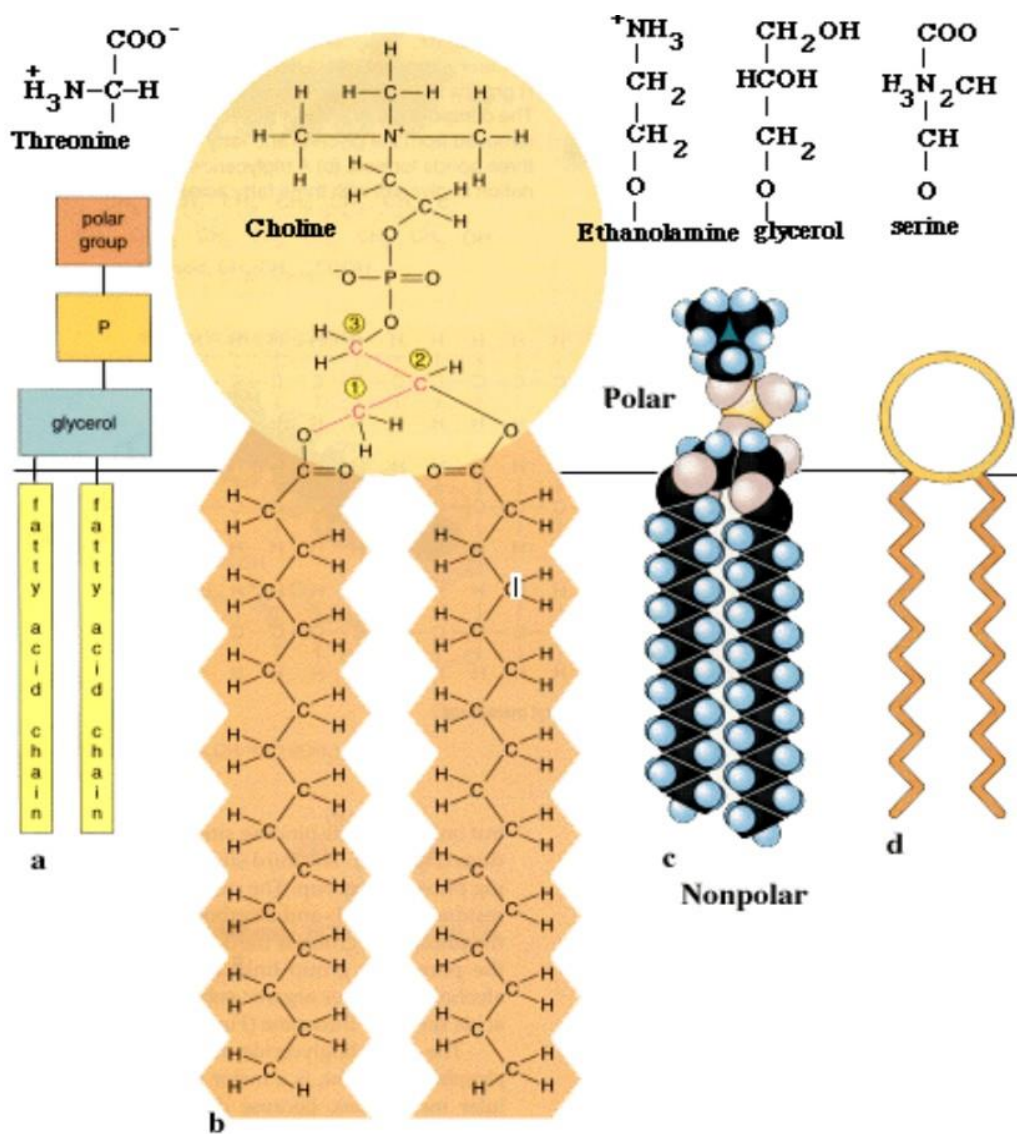

Figure 2.7. Bilayer lipid molecules.

A. Cell Membrane Structure

1. Components of the membrane

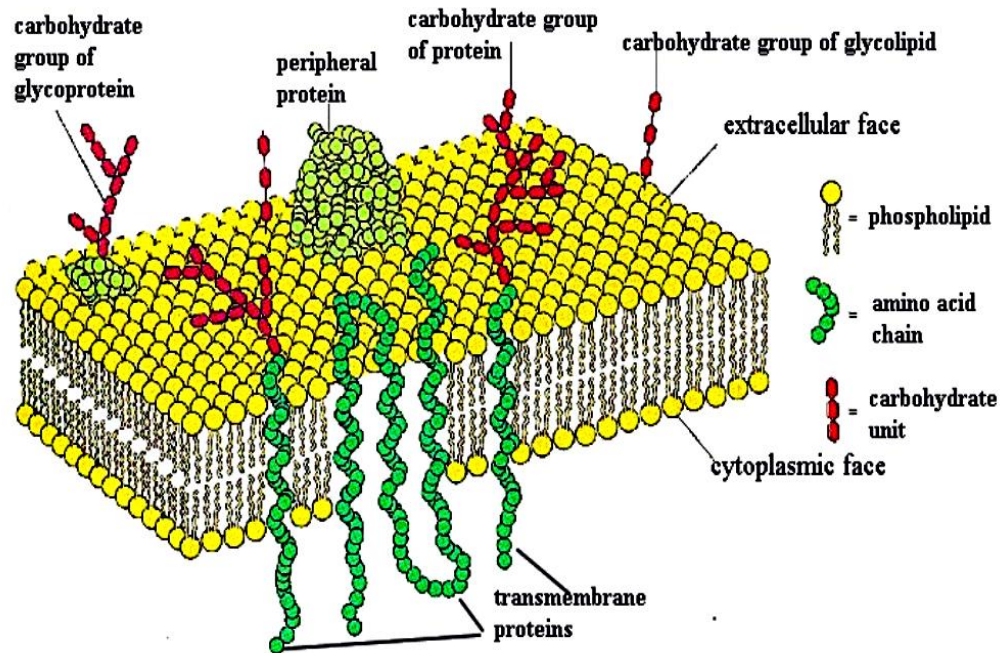

Figure 2.6. Components of cell membranes.

Mozaic Fluid models of membrane structure is strongly supported by visual evidence obtained during membrane studied using electron microscopy. Chemical Abalysis also reveals that the cell membrane is composed of lipids, proteins, and carbohydrates.

The three main ones are membrane phospholipids, glycolipids, and cholesterol. While the constituent proteins are membrane intrinsic proteins (integral) and protein porifer (extrinsic). Carbohydrate constituent of membranes is a glycoprotein. Furthermore, we will discuss more about the composition of the membrane.

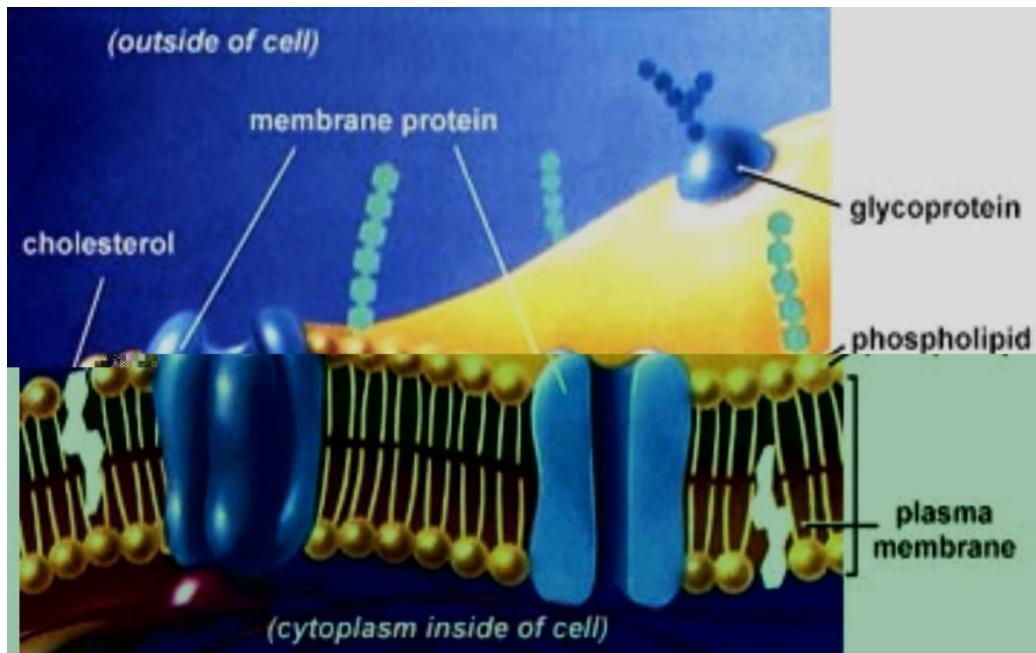

Figure 2.7. The structure of the cell membrane which limits its environment.

a. lipid membrane

1) Phospholipids

Phospholipids are esters of fatty acids with glycerol containing phosphoric acid and nitrogen. Phospholipids are the major phosphoglycerides were found, containing two molecules of fatty acid esters associated with the hydroxyl groups of glycerol. The third hydroxyl group in glycerol ester form bonds with phosphoric acid. Phosphoglycerides which are common are phosphatidyl choline, phosphatidyl serine, phosphatidyl ethanolamine, phosphatidyl inositol, and glycerol difosfatidil. Chain fatty acids in the phospholipids normally contain an even number of carbon atoms in, typical between 14 and 24 are the most common fatty acids - 14 and carbon - 16. Fatty acids can be saturated or unsaturated.

2) glycolipid

Glycolipids as the name implies, is a lipid -containing sugar. In animal cells, glokolipid, as well as sphingomyelin, derived from sphingosine. Amino group on the carbon skeleton isolated by sphingosine fatty acid as the carbon skeleton sphingomyelin. The difference between glycolipids and sphingomyelin contained on the type of fragment that binds to the primary hydroxyl groups on the carbon skeleton sphingosine. In glycolipids, one or more of sugar binding to this group. The simplest glycolipid is cerebrosides, there is only one residual sugars, glucose and galactose. More glycolipid compound, eg gangliosides, containing branched chains consisting of as many as seven sugar residues.

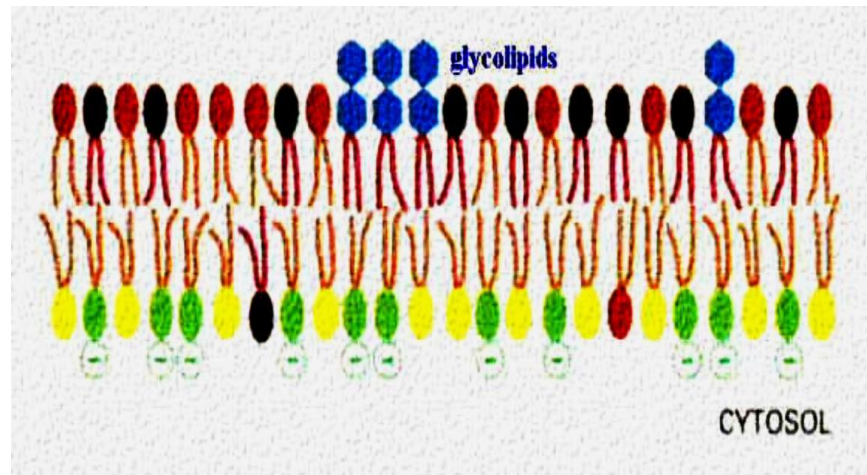

Figure 2.8. Glycolipid structures in the cell.

3) Cholesterol

Another important lipid in membranes is cholesterol. Cholesterol and derivatives thereof, with a long chain fatty acid which is an essential component of the outer cell membrane.

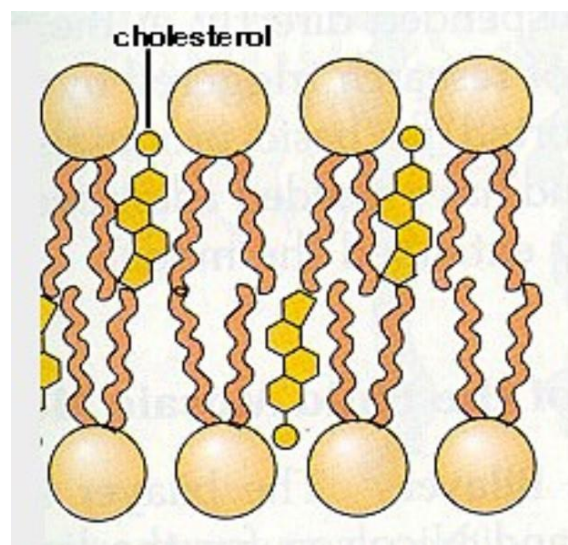

Figure 2.9. Cholesterol in the cell.

b. membrane proteins

1) Integral Protein (Protein Intrinsic)

Integral proteins are proteins that span the lipid bilayer. Intrinsic and integral membrane proteins containing hydrophilic and hydrophobic regions. Hydrophilic part of the protein interacts with the polar end of the lipid molecules on the surface of each of the bimolecular leaflet.

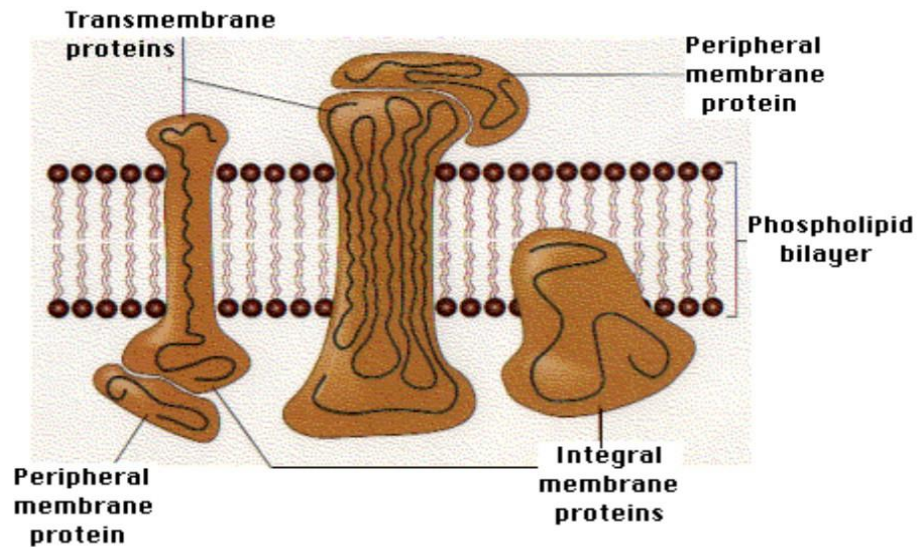

Figure 2.10.

Integral membrane proteins interact widely with hydrocarbon region on phospholipids bilayer (bilayer). Almost all integral membrane proteins that are already known, spans the lipid bilayer . Peripheral membrane protein binds to the surface of integral membrane proteins.

2) Protein Porifer (Protein extrinsic)

Porifer or extrinsic membrane proteins generally are loosely bound to the membrane protein that is rich in amino acids with hydrophilic side chain interactions with the environment that causes the surface of the water and polar lipids bilayer .

c. carbohydrates membrane

This section is a protein that contains covalently bound carbohydrate, which is a single monosaccharide or oligosaccharides are relatively short. Most secreted proteins leading to the outside of the cell relative is a glycoprotein, like most proteins in blood plasma. One of the cell membrane protein is the most widely known glikofirin (in red blood cells), which contains nearly 50 % carbohydrate in the form of a long polysaccharide chain covalently bonded to one end of the polypeptide chain. Polysaccharide chain extending from the outer surface of the cell membrane while immersed in the polypeptide chain in the cell.

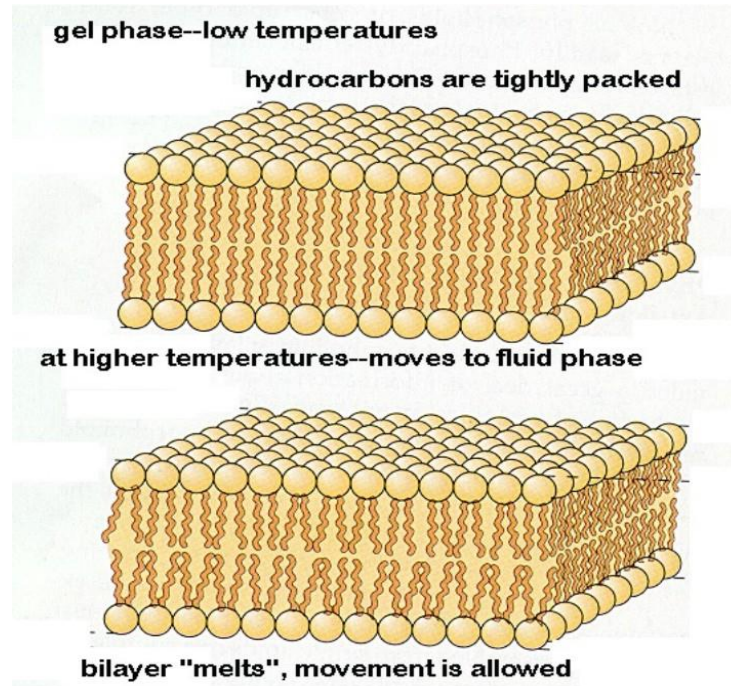

Figure 2.11. Cell membrane.

Ampifatik polar lipids are composed of compounds having a hydrophobic group (not like water) and hydrophilic (likes water). In the liquid system, polar lipids spontaneously dispersed, forming an arrangement of globular micelles are formed by the polar head groups are surrounded by water and hydrocarbon chains clustered face to face, with the lipid hydrocarbon tails are hidden from the liquid environment and the hydrophilic head electrically charged open on the surface, in contact with a liquid medium.

Liquid lipid to form a layer with a thickness of one molecule is a single layer. In such systems, the hydrocarbon tails exposed to the air, so to avoid the water, and the hydrophilic head extends into the liquid phase that is polar. Too soon and polar lipids spontaneously form a double layer is very thin, which separate two liquid compartments. In the structure of the hydrocarbon tail extends into the lipid molecules in continuous, and the hydrophilic heads facing outward, extending into the liquid phase. Phospholipid bilayer thickness of approximately 6-7 nm (see Figure 2.11).

2. Plasma Membrane properties

- a. Selectively permeable

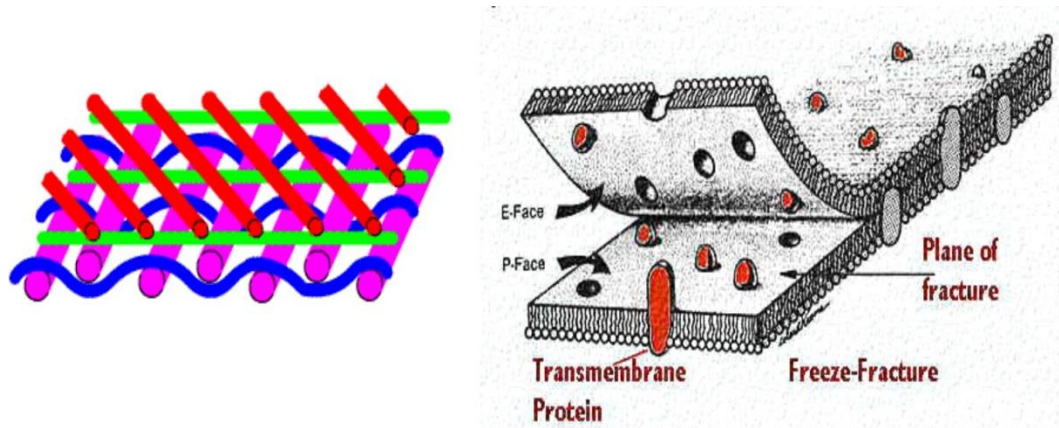

Figure 2.12. Bilayer lipids and proteins.

Semi-permeable nature of these can be caused by lipid and protein bilayer. Part blocking hydrophobic membrane ion transport and polar molecules, such as hydrophobic hydrocarbons, carbon dioxide and oxygen that can dissolve in the membrane and can cross it easily. Very small molecule that is polar but uncharged also can pass through the membrane rapidly. Examples are water and ethanol, which are small enough to pass between membrane lipids. When the lipid layer is not very permeable to uncharged polar molecules are larger, such as glucose and other sugars. Bilayer is also relatively impermeable to all ions, although it is very small ions such as H^+ and Na^+ . Charged atoms or molecules and the water layer is difficult to penetrate the hydrophobic layer of the membrane. However, lipid bilayer is just one part of the story about the relative membrane permeability. Proteins present in the membrane plays an important role in the regulation of transport. Because it's not all substances or molecules from outside the cell can enter through the plasma membrane. This is because the basic structure of the plasma membrane is composed largely of lipids (phospholipids) that can only be bypassed by certain molecules to the protein intermediate carrier.

b. The nature of membrane fluidity

Membrane is not static sheets of molecules are bound firmly in place. Membranes were arrested together primarily by hydrophobic interactions, which are much weaker than covalent bonds. The nature of membrane fluidity is determined by the factors below;

1) The movement of phospholipids

Most phospholipids can move randomly in the field of membrane. Phospholipids move to maintain membrane fluidity. Phospholipids move quickly along the plane of the membrane, approximately 2 μm size of a bacterial cell length. The movement of these phospholipids are of two kinds; lateral movement (in two dimensions / on one layer only) and the movement of flipflop / swap places (from the outside to the inside layer

and vice versa). But rarely occurs a molecule change places transversely across the membrane, which switch from one phospholipid layer to the other layers because to do so, partly hydrophilic layer must traverse the hydrophobic core of the membrane.

2) Fatty acid unsaturation

A tangible fixed membrane fluid so the temperature drops, until finally, at some critical temperature, phospholipids deposited on a dense arrangement of the membrane freezes. Tangible fixed membrane fluid at lower temperatures if it contains many membrane phospholipids with unsaturated hydrocarbon tails. This is caused by the presence of double bonds tangling in place. In other words, the presence of double bond position can complicate the carbon chains that are composed of solid, so that the membrane can inhibit the clotting process when the temperature is low. Greater number of double bonds in the hydrocarbon membrane phospholipids will be more liquid.

To maintain fluiditasnya membranes of living cells at low temperatures has the proportions of a higher fatty acid. Other evidence suggests that the cell can alter the balance of saturated fatty acids and unsaturated the membrane becomes an adaptation to the change of temperature.

3) The presence of cholesterol

Cholesterol also plays a key role as a controller of membrane fluidity. Cholesterol -containing steroid nucleus with a hydroxyl group on one side and a flexible hydrocarbon tail on the other side. Cholesterol inserted between phospholipids with axis perpendicular to the plane of the membrane. Cholesterol hydroxyl groups to form hydrogen bonds with the carbonyl oxygen atom in the phospholipid head groups. While the hydrocarbon tail of cholesterol is located in the center of the nonpolar lipids bilayer . Cholesterol prevents crystallization rantairantai fatty acids to infiltrate them. Basically a high concentration of cholesterol prevents movement of phospholipids. This is the opposite effect of cholesterol which inhibits fatty acid chains do not move so that the membrane becomes less liquid. It can be concluded that the cholesterol dampen membrane fluidity.

4) attachment protein on the filament sitoskeleton

There is bound to the protein filaments that can maintain shape sitoskeleton membranes are fluid though. The sticking outside the frame combine to give a more powerful than can be provided by the plasma membrane itself.

c. Dynamic

Dynamic of the plasma membrane are the molecules of the plasma membrane is a phospholipid and protein. Phospholipids at normal temperatures (eg 37 ° C in prokaryotes) would be under normal conditions, but at higher temperatures phospholipids will be easy to move and so if the shorter fatty acids it will be more easy to move.

d. Membrane as a mosaic

The plasma membrane is called mosaic because the location of the components (proteins) that are not regular. This facilitates a transport agent. Plasma membrane and organelle membranes of various kinds each have unique collections of proteins. Until now it has been found more than 50 types of proteins in the plasma membrane are arranged with an irregular pattern.

e. asymmetric

Lipid molecules making up the outer layer of the plasma membrane is different from the interior constituent. Similarly, peptide molecules and carbohydrate. Most of the carbohydrates consist of glycolipids, glycoproteins, and proteoglycans. These carbohydrates only on the outer surface of the plasma membrane, because it is on the outside being more complex arrangement. This is to support its function as receptor molecules specific or typical agents such as viruses and bacteria. It can also be a receptor to environmental changes such as temperature, light intensity and others.

3. Plasma Membrane Function

Plasma membrane has a very complex function, not just skin inert membrane that encloses the cell and it's not a static structure that remains as dynamic membrane run many complex functions. Membranes with other cell organelles that perform many functions dynamically. In general, membrane function is as follows:

- a. As a barrier between the environment inside the cell with the environment outside the cell and the environment among the organelles in the cytoplasm environment.
- b. Regulate membrane permeability to compounds or ions to pass through. Permeability is mainly governed by integral proteins.
- c. Protein identification or specific receptor molecules such as hormones, antigens metabolism and typical agents such as bacteria or viruses. In addition to the membrane as a group of molecules can also function as a receptor to changes in temperature, light intensity and others.
- d. As a way to exit the entry of substances into the cell from the outside or vice versa. The transport section will be discussed further in the next section.
- e. Provides enzyme for the plasma membrane serves as a means of implementation of cellular activity is organized. For example, cytochrome enzymes involved in respiration are part of the mitochondrial membrane.
- f. Play a role in energy transduction. Change one type of energy into another form (transformasi) is important in the activity of living beings, and the membrane is directly related to this case. Examples of plants in which the ability of plant cells to capture the sun's energy and turn it in the form of chemical energy contained in the carbohydrates.

B. Movement Across Cell Membranes

Cell membranes are a barrier to most substances, and this property allows materials to be concentrated inside cells, excluded from cells, or simply separated from the outside environment. Certain substances, for example, had to move into the cell in order to support the cells remain alive, and vice versa. This is compartmentalisation is essential for life, as it enables reactions to take place that would otherwise be impossible. Eukaryotic cells can also compartmentalise materials inside organelles. Obviously materials need to be able to enter and leave cells, and there are five main methods by which substances can move across a cell membrane:

Waste materials generated from the metabolism of the cells must be removed from the cells that subsequently thrown out of the body. As described previously, the plasma membrane serves as a wall or barrier between living matter and non - living substances, among several intracellular membrane cytoplasmic space.

As a barrier, preventing the plasma membrane antarzat free exchange with each other, but at the same time the plasma membrane also serves as something that provides a means of communication between the chamber. Each cell requires nutrients, water, oxygen, ions, substrates, and others from the environment, whether it is a blood flow of a multicellular organism or a medium in which a single-celled organism is growing. It is the responsibility of the plasma membrane to ensure that all suitable welcome the substance into the cytoplasm and vice versa. In this capacity, commonly referred to as the plasma membrane selectively permeable membrane.

Among the substances are allowed to enter the space in the cell, some of which are filtered only by a diffusion process in response to a difference between the level of concentration in the membrane. In this case, the plasma membrane acts as a fence that can close and open. Several other substances carried through the membrane and thus maintained a high level of concentration while in the cell, the plasma membrane serves as a molecular pump. Several other substances including liquid in which it resides, can be shown into the cell by the formation of vesicles from the plasma membrane. One of the most important consequences of the position of the plasma membrane as a selective permeable membrane is its capacity to separate ions that exist and therefore gave rise to an electric potential difference between its parts. The electric potential difference is harmful to something known as a bully cells, neurons and cells of the body, but at the same time also plays an important role in terms of the ability of each cell to respond to its environment.

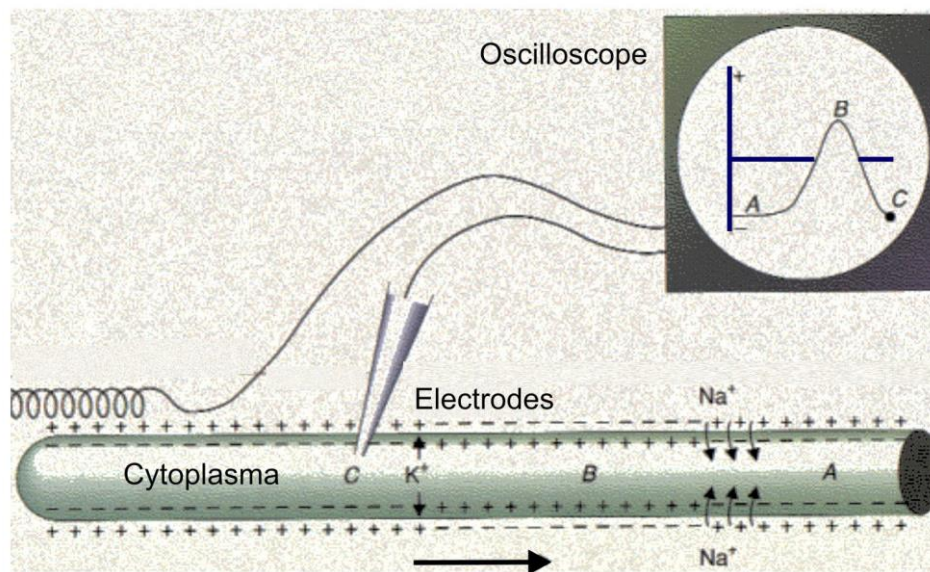

Figure 2.13.

Impulse in neuronal cells. Potential difference turf in neurons leads to ion transport mechanisms (K^+ and Na^+).

Regulation of these substances are not just limited to the movement from outside to inside the cell by the plasma membrane. Various intracellular bulkhead must also relate to each other. No independent organelles, each relies on the exchange of substances in both directions between the membrane where they are bound. In general there are two kinds of transport processes through the cell membrane is passive transport and active transport.

1. Passive transport

Passive transport is the simple movement of a substance with a concentration difference inside and outside the cell. If the concentration is higher outside the cell, then there is the movement of molecules from the outside to the inside, otherwise if the concentration is higher inside the cell, the movement of molecules from the cell kelingkungan. The difference in concentration of cells with their environment is called a concentration gradient. Passive transport in response to a concentration gradient does not require energy. Some of the processes that take place that indicate passive transport

a. diffusion

A few substances can diffuse directly through the lipid bilayer part of the membrane. The only substances that can do this are lipid-soluble molecules such as steroids, or very small molecules, such as H_2O , O_2 and CO_2 . For these molecules the membrane is no barrier at all. Diffusion is the movement of a particular substance from high concentration to lower concentration. Substance diffuses according to the slope (gradient) concentration, and for this it does not require energy (ATP). Diffusion can be divided into simple diffusion and facilitated diffusion (often also called a conditional diffusion or diffusion -facility).

1) Simple Diffusion / Free

In simple diffusion molecules move in the direction of the concentration gradient. In free diffusion, a substance diffuses freely without requiring direct or protein carrier (carrier). In general, the metabolites that can cross the membrane through simple diffusion is a metabolite of small molecular weight, such as water, O₂, ethanol, CO₂, fatty compounds and other small molecules moekul polar uncharged can penetrate directly in between - between lipids. In addition, the protein also has a channel in the middle.

Free diffusion mechanism, namely, the dissolved molecules are fixed, moving, and collide repeatedly every second. Molecular collisions occur randomly. Finally, the random movement of molecules to carry several different areas, so there is no change in concentration between the two regions. Degree of concentration difference between the outside and inside of the membrane will be lost when the diffusion has been completed. Diffusion is a free and simple this is not an overly important transport mechanism in the membrane because it runs slow.

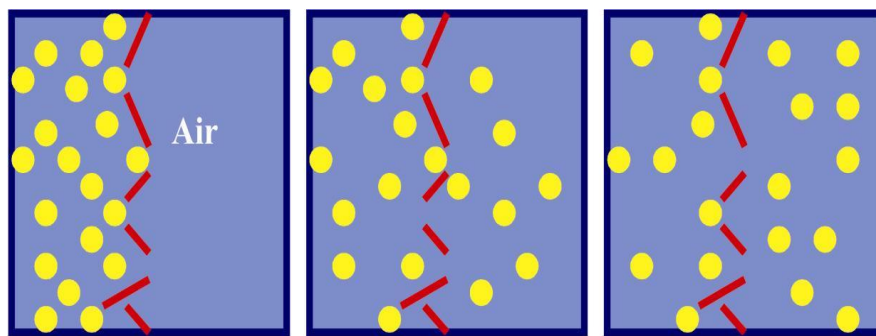
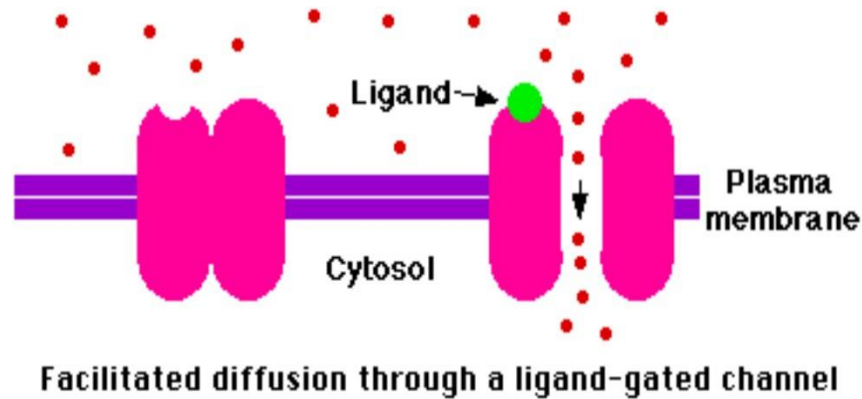

Figure 2.14. Simple diffusion.

2) Conditional Diffusion

In principle, the same conditional diffusion with diffusion-free, that is required in terms of differences in the concentration and in the process does not require energy. While the difference is in the process of diffusion where movement of compounds across the membrane much faster due to carrier proteins in the membrane. In a fully diffusion, diffusion is also influenced by the saturation of the carrier protein to that substance. Carrier proteins transport substances can not pass through the lipid layer directly, for example ions and other polar compounds charged. Lipid bilayer is not very permeable to all ions even small ions such as H⁺ and Na⁺, so that the transport has to go through the carrier protein.



Source: [www. Cellsbio.com](http://www.Cellsbio.com)

Figure 2.15. Conditional diffusion through the membrane.

The stages in the Conditional diffusion are:

- 1) The initial phase
Namely the introduction phase (recognition) of the molecule metabolites that will undergo transport into cells with a protein carrier.
- 2) Phase binding
Carrier molecules contained in the membrane to form specific complexes with metabolites that are outside the membrane.
- 3) Phase movement
The movement of the complex to the deeper part of the membrane. How can movement through the mechanism of diffusion, rotation, oscillation and other movements.
- 4) Phase release
At this stage the release of metabolites into the cells through the mechanism of association, dissociation, and translocation.

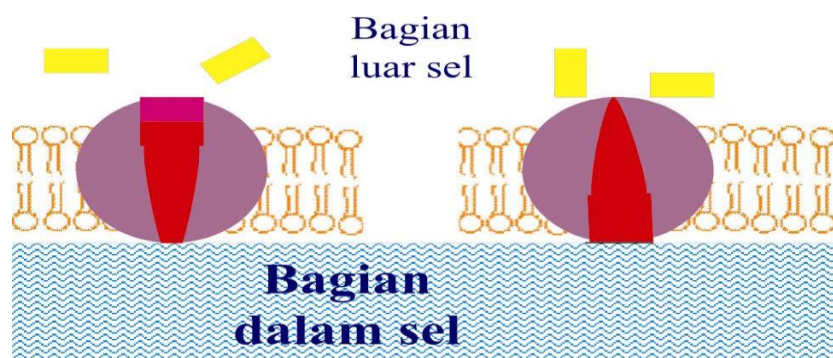

Figure 2.16. Conditional diffusion process.

b. Osmosis

Osmosis is the process of entry and exit of water through the plasma membrane is selectively permeable. The water moves from low concentration solution leading to the solution of high concentration. Water can pass through the membrane directly,

but glucose can not penetrate a semipermeable membrane. With a certain time the water will move towards a solution of glucose, to increase the concentration of the solution next to it. So here is the movement of water molecules toward glucose. The results of water will move through the membrane in response to a concentration gradient. Osmosis will stop when it happened equilibrium concentration inside and outside the cell (existence of equivalence), because of the presence of other forces which resist, the reaction force of the membrane. When the strength of the membrane is weaker than the strength of the entry of water in the cell then the cell will rupture (lysis).

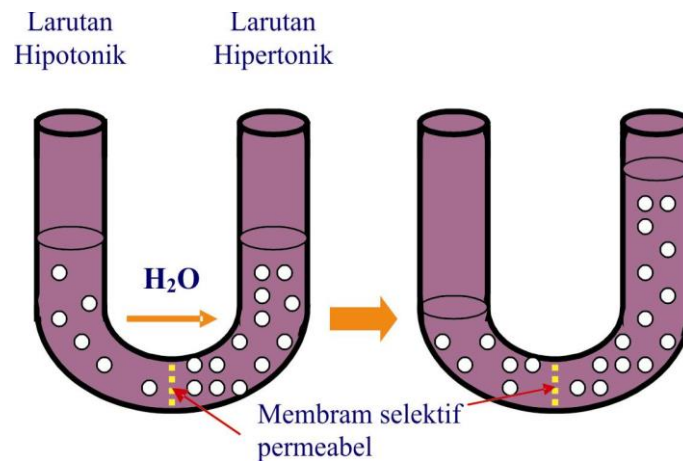

Figure 2.17.

Two different concentrations of sugar solution separated by a porous membrane that is permeable to the solvent (water) but not the solute (sugar). Water diffuses from a hypotonic solution to a hypertonic solution. Passive transport of water, or osmosis, reducing sugar concentration difference.

2. Active transport

Active transport is the movement of compounds across a membrane from an area of low concentration to areas of high concentration (against the concentration gradient). In active transport the energy required is provided mainly on Adenosine (ATP). One example of active transport is the pumping of Na^+ ions and K^+ .

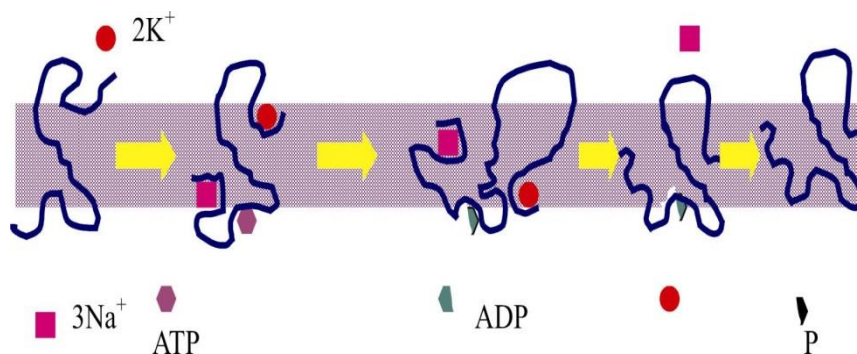

Figure 2.18a. Active transport of ATP and ADP.

The concentration of K^+ ions in cells maintained for AI always higher than outside the cell. Instead of Na^+ ion concentration in the cultivated cells were always lower than outside the cell. Ions Na^+ and K^+ are both pumped against a concentration gradient, and pumping can occur as a result of ATP hydrolysis.

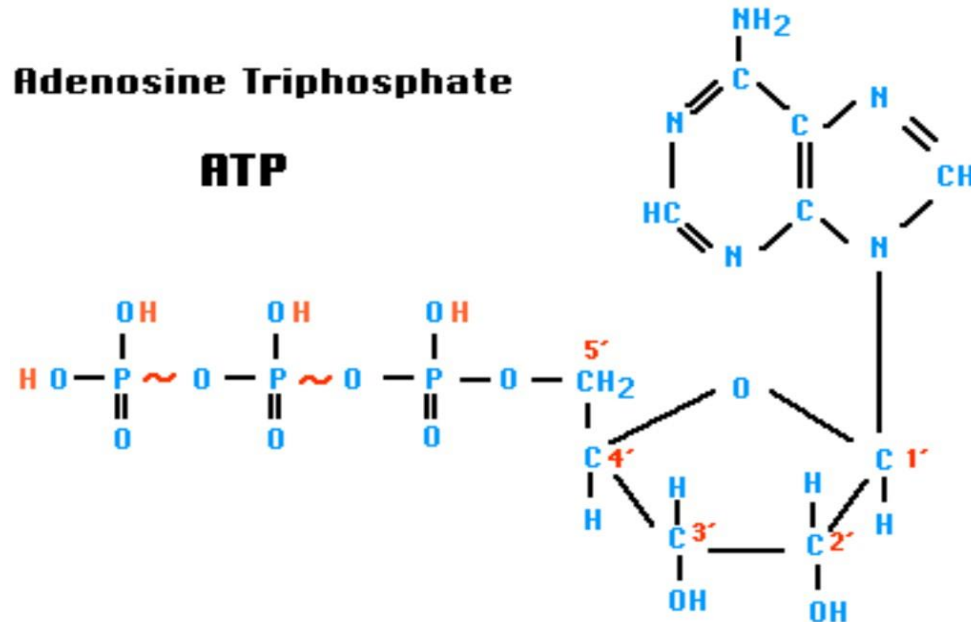

Figure 2.18b. Bond of ATP.

Active transport mechanism through two stages, namely

- a. The process of changing the carrier of X into X^0 by using energy system. X is then able to bind metabolites into X^0 . This complex moves toward the deeper part. Due to changes in the environment that affect the rapid dissociation and a detached enter the cell, and X^0 spontaneously turned into X.

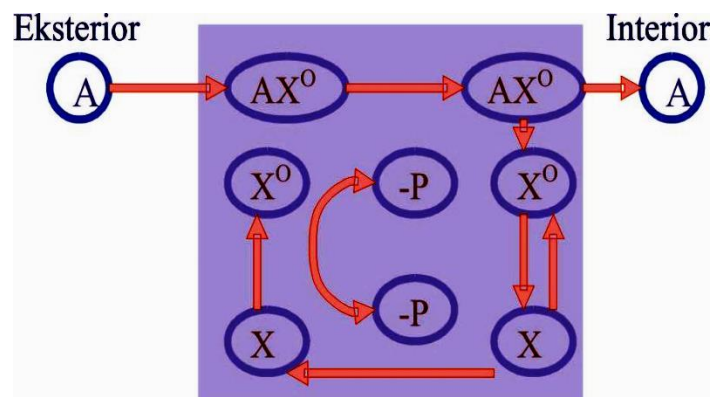

Figure 2.19a. The first way of active transport (Conn & Stumpf, 1972:136).

- b. Similar to the first mechanism, the difference between a chemical change, such as phosphorylation events occur, but soon changed back to its original structure when released into the cell.

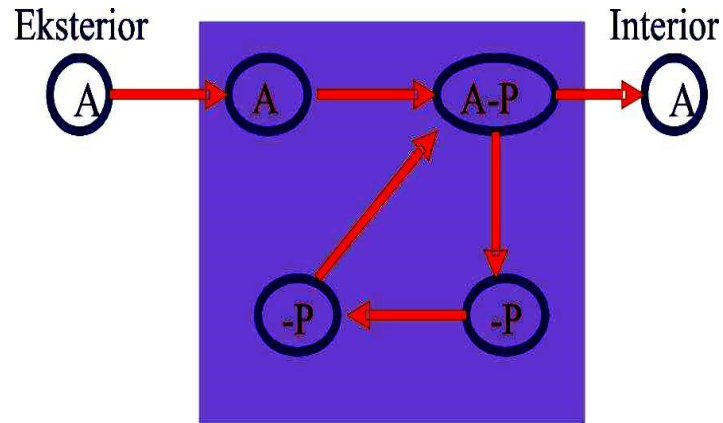

Figure 2.19b. The second way of active transport (Conn & Stumpf, 1972:136).

Some examples of active transport systems are:

- Intake of amino acids, peptides, nucleosides and potassium in bacteria *Escherichia coli*. The new material can get into the cell and if there is enough energy carrier.
- Marine algae can hoard iodine in the cell exceeds the concentration in the surrounding seawater.
- Sodium and potassium ion pumps.

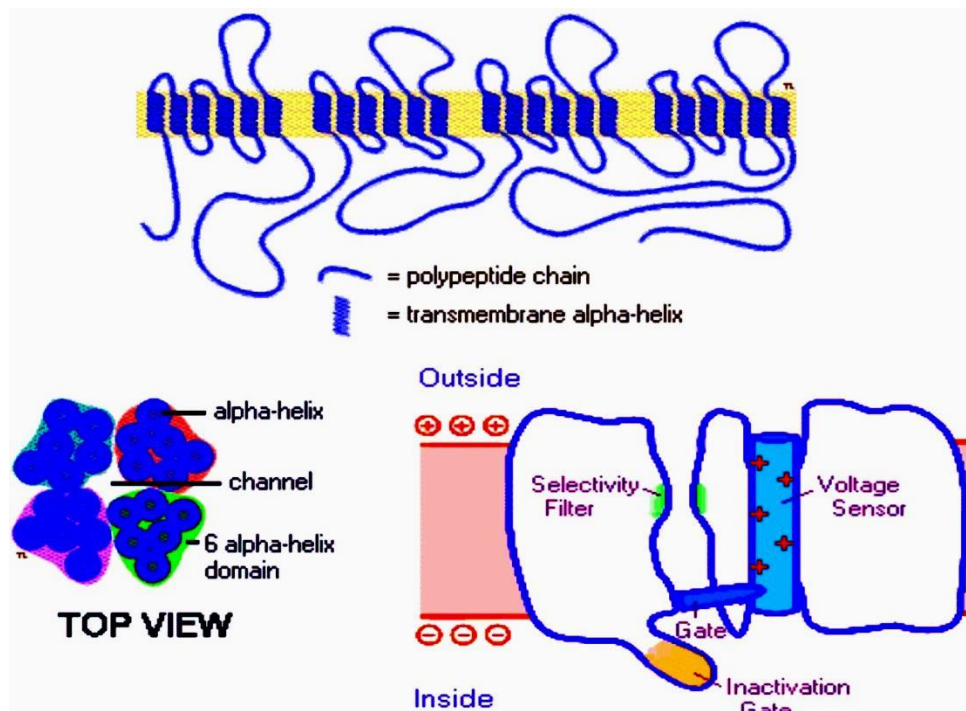

Figure 2.19c. Sodium and potassium ion pump.

3. Cytosis

Cytosis is transport involving membrane rupture (lysis). This process involves lysosomes, means the substance is digested and transferred in vesicles. The process of taking the substance by a cell of approximately through the plasma membrane in general is called endocytosis (endocytosis) and spending is called exocytosis (exocytosis). Things to consider in this process is the substance that is being inserted or removed in vesicles, separated from other macromolecules dissolved in the cytosol.

a. endocytosis

Endiositosis is the process of taking a substance by a cell from its surroundings through the plasma membrane in general. Some forms of endocytosis are:

1) Phagocytosis

Phagocytosis (Greek; phagein = food) is the process of making the solid particles are rather large in size, such as bacteria or fragments of damaged cells. In the amoeba, the process begins with the formation of pseudopodia from cells which then surrounds eating. Once the plasma membrane to form a tear while food vacuole, the vacuole wall next united with lysosomal membrane containing hydrolytic enzymes that can digest eating. Digested food is absorbed in the cytoplasm was useless dregs are removed from the cell by exocytosis process.

2) pinocytosis

Pinocytosis (Greek; pinein = drink) is a food-making process of the liquid surrounding the particles are so small that it dissolves in liquid. Plasma membrane invagination hold, forming a long and narrow channel at the ends to form vacuoles. The vacuole eventually break away so that it can be absorbed by the cytoplasm. Water and carbohydrate are not able to stimulate pinocytosis.

3) receptor mediated Endocytosis

Some particles, such as proteins and lipoproteins are selectively taken up by cells attached to the first receptor protein found on the plasma membrane and subsequent invagination of the plasma membrane held together with a receptor that binds particles required. Lipoprotein particles are taken up by cells containing cholesterol and fats in the interests of the membrane.

b. exocytosis

In the process of exocytosis, a vesicle or vacuole membrane contained in the cytoplasm initially attached to the plasma membrane. Then the plasma membrane open for a while so that the contents of the vesicles or vacuoles can be removed from the cell. Substances released which include secretion (eg hormones) or undigested particles.

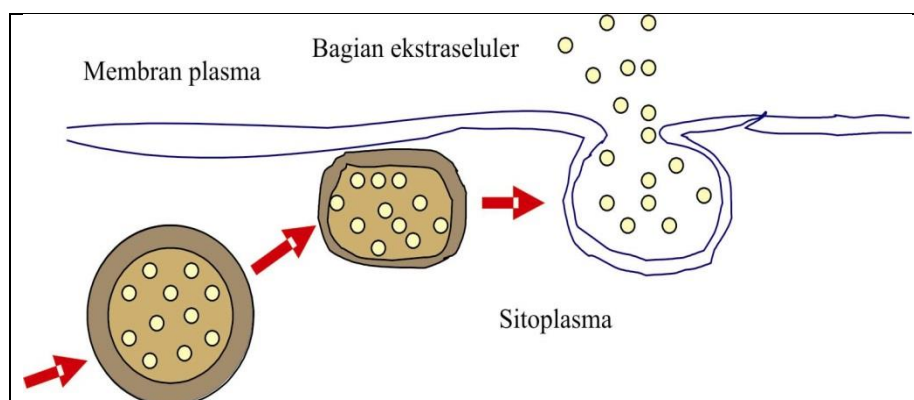
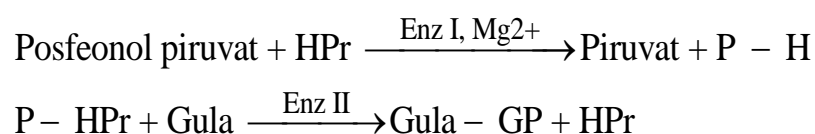

Figure 2.20. The process of exocytosis.

4. Translocation Group

Sugar is a transport mechanism across the bacterial membrane. Based on the mechanism of sugar released into the cell in the form of phosphorylated derivate. This requires active transport mechanism, so that the sugar - phosphate can not escape back through the membrane. This mechanism includes the reactions:



B. Nerst and Gaultman Equation

Next we analyze the existing movement of charged particles in the membrane. Although the main ions move through a hole or cavity, but we'll see diffusion of ions into homogeneous regions, to determine how the ion flux response to the concentration of the solution and the electric potential existing on the membrane.

Flux of the type of content in homogeneous media in line with the following equation.

$$F = -D\nabla C + \mu q C E \quad \dots (2.1)$$

where E is the electric field, which is expressed by, where V is the electric potential energy, mobility and q the ion charge. The right of the equation is Fick's law and the distribution of the second equation is a form of Ohm's law for the motion of charge carriers in the medium viscous diffusion coefficient for the ion type i can be associated with mobility by using the Stokes - Einstein relation in which that equation (2.1) to be a one-dimensional geometry,

$$F_i = -\mu_i \left(k_B T \frac{\partial C_i}{\partial x} + q_i C_i \frac{\partial V}{\partial x} \right) \quad \dots (2.2)$$

If the steady state is achieved, it will be worth the constant flux versus time. Now let's look at selective membrane, which can only be penetrated (permeable) by a single type of ion, say K⁺. Equation (1.1) can be multiplied by a factor of incorporation exponent ($Q_i V / k_B T$) and can be combined to produce a single ion flux as a function of the concentration of energy that hit the membrane.

$$F_i = -\mu_i k_B T \frac{\int_1^2 d(e^{V/V_0})}{\int_1^2 e^{V/V_0} dx} = \mu_i k_B T \frac{C_i(1)e^{V_1/V_0} - C_i(2)e^{V_2/V_0}}{\int_1^2 e^{V/V_0} dx} \quad \dots (2.3)$$

where V_0 is expressed here by $V_0 = k_B T / q_i$. To get a more explicit solution, requires knowledge of the actual potential profile to evaluate the integral in the denominator. For a very thin membrane, we could question or say that the existing field in the membrane is very constant (see Figure 2.21), so that the potential energy can be uniformly or according to distance. In this case, if we declare $V = V_2 - V_1$, then the equation will be as follows.

$$J_i = q_i F_i = \frac{\mu_i q_i^2 \Delta V C_i(2) e^{V/V_0} - C_i(1)}{d e^{\Delta V/V_0} - 1} \quad \dots (2.4)$$

equation (2.4) is known as an approach to field - constant (constant- field approxi - mation) for the transmembrane voltage-current relationship.

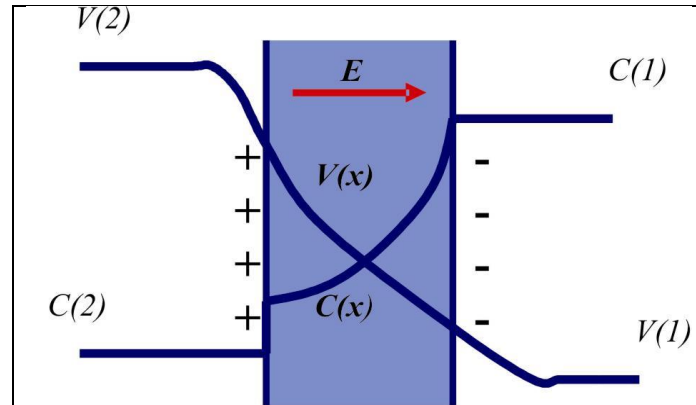

Figure 2.21. Potential electricity through a thin membrane.

What happens if the ion flux is zero? Because the ion current flowing through the membrane, the charge imbalance may occur. Formation of this charge will form an electric field that is opposite to the flow of ion diffusion. In the steady state, if the flux is zero, there will be the energy that goes into the membrane. With $F = 0$ in equation (1.4), we find that, by using $C_i(1)/C_i(2)$, the following equation is obtained.

$$V_1 - V_2 = -\left(\frac{k_B T}{q}\right) \ln\left(\frac{C_1}{C_2}\right) \quad \dots (2.5)$$

Next we will look at some of the membrane can be penetrated by some type of monovalent ions, each of which is characterized by the presence of mobility. If the ions move freely, then the total transmembrane current is the sum of the elements that exist in the equation (1.5), ie

$$J = -\frac{Vq^2}{k_B T} \left[\sum_i \frac{P_i^+ \left((C_i^+)_1 - (C_i^+)_2 e^{V/V_0} \right)}{1 - e^{-V/V_0}} + \sum_i \frac{P_i^- \left((C_i^-)_1 - (C_i^-)_2 e^{-V/V_0} \right)}{1 - e^{-V/V_0}} \right] a \quad .. (2.6)$$

To make the equations (1.5) and (1.6), we have connected the intrinsic ion permeability P_i ; mobility μ_i by the equation $P_i = D/d = k_B T/d$, where d is the thickness of the membrane. Then A and B is expressed as follows.

$$A = \sum_i P_i^+ (C_i^+)_1 + \sum_i P_i^- (C_i^-)_2 \quad B = \sum_i P_i^+ (C_i^+)_2 + \sum_i P_i^- (C_i^-)_1 \quad .. (2.7)$$

for steady state $J = 0$, we obtain

$$A - B e^{V/V_0} = 0 \quad \dots (2.8)$$

or for the rest of the membrane energy

$$\Delta V = V_2 - V_1 = \frac{k_B T}{q} \ln \frac{\sum_i P_i^+ (C_i^+)_1 + \sum_i P_i^- (C_i^-)_2}{\sum_i P_i^+ (C_i^+)_2 + \sum_i P_i^- (C_i^-)_1} \quad \dots (2.9)$$

Equation (1.9) is known as the equation of Goldman - Hodgkin - Katz, and often is used to calculate the relative permeability of certain ions on the membrane. Derivative formula assumes that all ions into the membrane and that the relative permeability remains: if the permeability change, then the relationship is likely to become more complicated.

EXERCISE

To improve your understanding of the material above, do the exercises below!

1. Explain what the point of the membrane has a shape like a mosaic!
2. What causes the plasma membrane selectively permeable properties?
3. Explain how the function of cholesterol in the membrane!
4. Explain briefly what are the functions of cell membranes in general!
5. Briefly describe the difference between intrinsic and extrinsic proteins in the membrane!

Instructions to Answer Exercise

If you have difficulty in answering the questions above consider the answers below as a reference.

1. The plasma membrane is called mosaic because the location of the components (proteins) that are not regular. This facilitates a transport agent. Plasma membrane and organelle membranes of various kinds each have unique collections of proteins. To date have been found more than 50 types of proteins in the plasma membrane that is composed with po - la irregular.
2. Can be caused by a semi-permeable nature of the lipid and protein bilayer , part hidrofibik blocking membrane ion transport and polar molecules. Hidrofibik nature such as hydrocarbons, carbon dioxide and oxygen that can dissolve in the membrane and can cross it easily. Very small molecule that is

polar but uncharged also can pass through the membrane rapidly. Cholesterol also plays a key role as a controller of membrane fluidity.

3. Cholesterol prevents crystallization of the fatty acid chains to infiltrate among them. Basically a high concentration of cholesterol prevents phosphodiesterase - lipid movement. This is the opposite effect of cholesterol which inhibits fatty acid chain did not perform the movement so that the membrane becomes less liquid. It can be concluded that the cholesterol dampen membrane fluidity.
4. The function of the cell membrane, among others: as a barrier between the environment inside the cell with the environment, regulating membrane permeability to compounds or ions that pass through it, as a special receptor molecules such as hormones, antigens metabolism, the way for entry and exit of substances outside to inside the cell or on the contrary, the enzyme provider, and energy transduction.
5. Intrinsic proteins are proteins that span the gamut bilayer lipid layer. Intrinsic and integral membrane proteins containing hydrophilic and hydrophobic regions. Hydrophilic part of the protein interacts with the polar end of the lipid molecules on the surface of each of the bimolecular leaflet. While porifer or extrinsic membrane proteins generally are loosely bound to the membrane protein that is rich in amino acids with hydrophilic side chain interactions with the environment that causes the surface of the water and polar lipids bilayer .

RESUME

Plasma membrane is a plasma that limits the cell with its environment that are semipermeable. The entry of materials into the cell and the release of certain substances in the cell is regulated by a plasma membrane. The plasma membrane is very thin so it can only be visualized by electron microscopy. The plasma membrane is a layered arrangement with an irregular pattern and consist mainly of proteins and lipids. Membrane function can not be separated from the process of life. Make the plasma membrane of cells that form independent by separating the cell from its environment.

Model of the plasma membrane in accordance with its development are: Model Overtoon plasma membrane, plasma membrane model Goster & Grendel, Model Cakes Sandwich plasma membrane (Davson & Danielli), JP Plasma Membrane Model Robertson, Fluid Mosaic Model, and Bilayer Lipid Molecules.

The three main ones are membrane phospholipids, glycolipids, and cholesterol. While the constituent proteins are membrane intrinsic proteins (integral) and protein porifer (extrinsic). Carbohydrate constituent of membranes is a glycoprotein.

Some very useful properties of the membrane are: selectively permeable, membrane fluidity properties, dynamic membrane as a mosaic, and asymmetric. Meanwhile, among other functions: as a barrier between the environment inside the cell with the environment outside the cell and the environment among the

organelles in the cytoplasm with the environment, regulating membrane permeability to compounds or ions that pass through it, as a protein recognition or special receptor molecules such as hormones, antigens metabolism and typical agents such as bacteria or viruses as a way to exit the entry of substances into the cell from the outside or vice versa, because the plasma membrane enzyme provider serves as a means of implementation of organized cellular activity, and plays a role in energy transduction.

CHAPTER 3 METABOLISM AND ENERGY TRANSFORMATION

Metabolism (from Greek: *metabolismos*, "outthrow") is the set of life-sustaining chemical transformations within the cells of living organisms. Metabolism is a hallmark of life that occurred (emerging) from the specific interactions between the molecules in the cell environment is well organized. These enzyme-catalyzed reactions allow organisms to grow and reproduce, maintain their structures, and respond to their environments. The word metabolism can also refer to all chemical reactions that occur in living organisms, including digestion and the transport of substances into and between different cells, in which case the set of reactions within the cells is called intermediary metabolism or intermediate metabolism. Overall, the metabolism is associated with the arrangement of material and energy resources of the cell.

Metabolic process that occurs through the process of liberation of energy by way of overhauling the complex molecules into simpler compounds called catabolism (cellular respiration), examples of sugar/ glucose ($C_6H_{12}O_6$) or other organic material is converted into CO_2 and H_2O . The energy stored in organic molecules (sugars) can be used to carry out the work cell. Instead the energy consumption for building complex molecules from simpler molecules called anabolism, the example in the synthesis of amino acids into proteins. Metabolism is usually divided into two categories. Catabolism, that breaks down organic matter and harvests energy by way of cellular respiration, and anabolism that uses energy to construct components of cells such as proteins and nucleic acids. In the actual metabolic process can occur from the process followed by the process of anabolism catabolism or otherwise of the process of anabolism into catabolism.

Metabolism includes the process of synthesis (anabolism) and the decomposition (catabolism) compounds or components in living cells. All metabolic reactions catalyzed by enzymes. Another thing that is important is its role in the metabolism or detoxification penawaracunan, namely the conversion reaction mechanism of toxic substances into non-toxic compounds that can be excreted from the body. Anabolism to catabolism distinguished in several respects:

1. Anabolism is a process of chemical synthesis of small molecules into larger chemical molecules, while catabolism is the decomposition of large molecules into smaller molecules
2. Anabolism is a process requires energy, while releasing energy catabolism
3. Anabolism is a reduction reaction, an oxidation catabolism
4. The end result is a compound anabolism to catabolism beginners.

Metabolic processes that occur within cells is highly coordinated activity, involving the cooperation of various enzyme system catalyzing reactions require a gradual and metabolic regulation mechanism to control reaksinya. Metabolic processes of living organisms has three specific functions, namely:

1. To obtain the chemical energy in the form of ATP degradation substances rich food energy derived from the environment.

2. To change the molecules of food substances (nutrients) into precursor unit cell builder for biomolecules.
3. To compose units builders into proteins, nucleic acids, lipids, polysaccharides, and other cell components. To form and remodel biomolecules.

Energy is the basis of all metabolic processes so as to understand metabolic processes need to be understood first about energy. Energy for various functions of the human body comes from nutrient molecules that have been metabolized. In fact, the primary purpose of food intake is energy supply. This energy comes from fat, carbohydrate, and protein in food. Of the three, fat is the most concentrated source of energy because the polish is more than twice as much energy for a given weight as protein or carbohydrate.

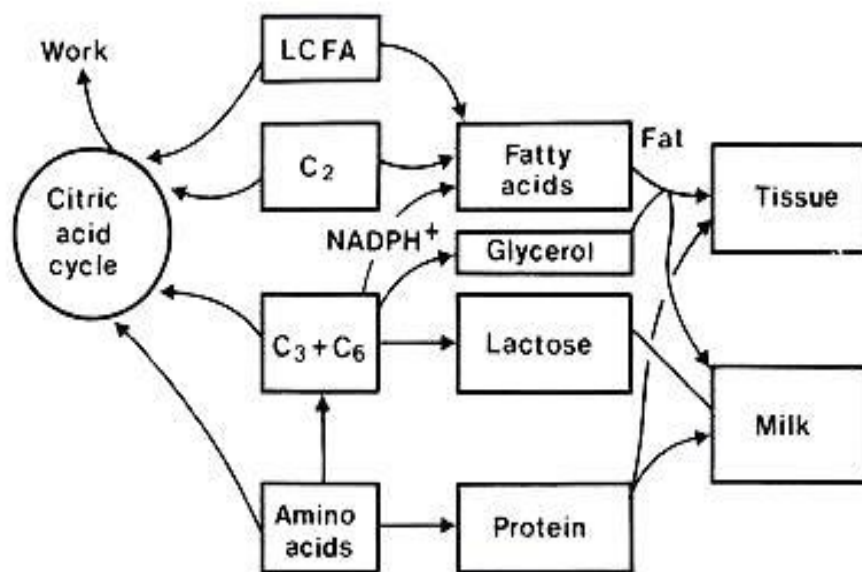

Figure 3.1.. Ruminant requirements for major metabolites according to productive state

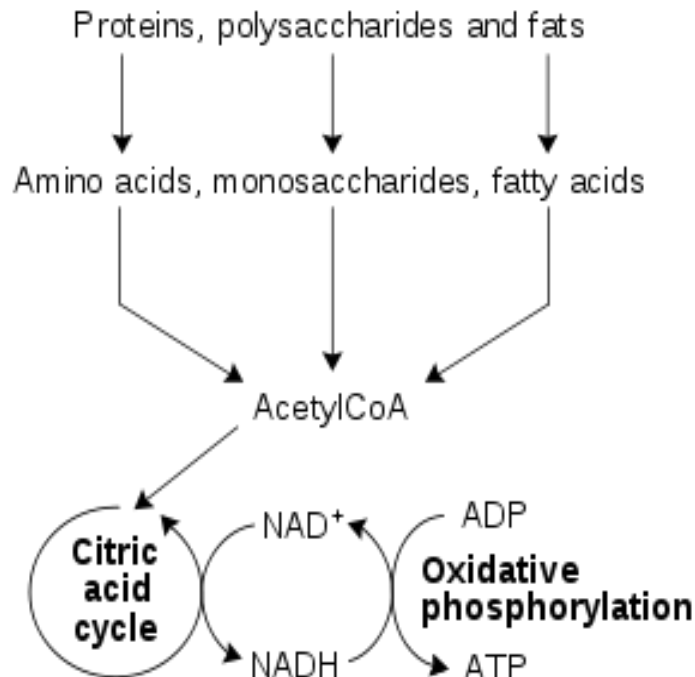

Figure 3.2. Transforming the Energy Metabolism

The chart can be explained as follows.

1. During the process of photosynthesis, solar energy is in the form of radiation or solar radiance of the sun transformed into chemical energy in the bonds of organic compounds. Coat f is the frequency of light and the symbol h is Planck's constant, which relates the energy and frequency.
2. During cellular respiration, the chemical energy in a chemical compound that is transformed into the form of ATP.
3. In the cell, the chemical energy -rich phosphate bond energy (ATP) can be used for mechanical work, electrical, and chemical.
4. In the end the energy flow around the cell and energy is lost as heat in the form of " entropy ".

A. Transformation Energy

Energy is the capacity or ability to carry out the work. Aktivitas work on the material in the cell can occur because of friction or gravity due process. Energy is also the ability to recycle a collection of materials (eg manure into compost). Each material has a shape shifting or moving energy called the energy of motion or kinetic energy.

Object or objects (the material inside the cell) moves do work in a way other moving objects, eg example muscle contraction will move or push the foot pedal. Light is also a form of kinetic energy that can be used to perform such work as the process of photosynthesis in green plants. Heat or thermal energy is also a kinetic energy that is generated from the random movement of molecules.

An object that was stationary and not moving while still having energy is the capacity to do work. Stored energy (potential energy) is the energy possessed by the material because of its location or structure, an example of energy saving water in the dam because of its height. Another example is the chemical energy stored in the molecules that form of energy because of differences in the structure of atoms.

Energy transformation processes in biological systems can be divided into the following three processes.

1. Transformation of energy by Chlorophyll

Radiant energy of sunlight is captured by chlorophyll is then converted into chemical energy through photosynthesis. The chemical energy is used to synthesize CO₂ and H₂O into glucose and other complex compounds as binding energy and the coupling nuclei stored in the form of carbohydrate compounds (as food). Thus, solar radiation energy in the form of kinetic energy and potential energy is converted into chemical energy stored in molecules of carbohydrates and other food items as energy bond linking atoms default.

2. Transformation of energy by mitochondria

Chemical energy in the mitochondria is used to convert carbohydrates and other compounds as energy phosphate bonds through cell respiration for the oxidation of DNA, RNA, proteins, and fats. Many mitochondria found in muscle cells of living beings and nerve cells.

3. The transformation of energy by the cell

If cell activity, the chemical energy of the phosphate bond will be separated and transformed into other forms of energy such as mechanical energy for muscle contraction work, electrical energy to carry nerve impulses, energy synthesis for building compound growth, and the rest will flow around the cell and lost as heat energy. As previously described, in the course of metabolic processes in living cells, there are several important components that play a role in it that is the activity of the enzyme, resulting in high energy adenosine triphosphate (ATP) and the oxidation-reduction reaction (release and liberation) electrons.

Setting the conversion or transfer of energy to follow the laws of thermodynamics. Thermodynamics is the study of energy transformations that occur in the material. The laws of thermodynamics define fundamental physical quantities (temperature, energy, and entropy) that characterize thermodynamic systems.

1. **The First Law of Thermodynamics**

Energy can be changed from one form to another, but it cannot be created or destroyed. The total amount of energy and matter in the Universe remains constant, merely changing from one form to another. Humans can convert the chemical energy in food, like this ice cream cone, into kinetic energy (the energy of movement to ride a bicycle). Plants can convert electromagnetic radiation (light energy) from the sun into chemical energy. According to the first law of thermodynamics; (1) the total amount of energy in the universe is constant, (2) energy may be transferred from

place to place or transformed into different forms; however, it cannot be created or destroyed, (3) living organisms have evolved to obtain energy from their surroundings in forms that they can transfer or transform into usable energy to do work.

A way of expressing the first law of thermodynamics is that any change in the internal energy (ΔU) of a system is given by the sum of the heat (q) that flows across its boundaries and the work (w) done on the system by the surroundings:

$$\Delta U = q + w \quad \dots(3.1)$$

This law says that there are two kinds of processes, heat and work, that can lead to a change in the internal energy of a system. Since both heat and work can be measured and quantified, this is the same as saying that any change in the energy of a system must result in a corresponding change in the energy of the world outside the system. In other words, energy cannot be created or destroyed. If heat flows into a system or the surroundings to do work on it, the internal energy increases and the sign of q or w is positive. Conversely, heat flow out of the system or work done by the system will be at the expense of the internal energy, and will therefore be negative.

2. The Second Law of Thermodynamics

The Second Law of Thermodynamics states that "in all energy exchanges, if no energy enters or leaves the system, the potential energy of the state will always be less than that of the initial state." This is also commonly referred to as entropy. The second law of thermodynamics says that the entropy of any isolated system not in thermal equilibrium almost always increases. Isolated systems spontaneously evolve towards thermal equilibrium—the state of maximum entropy of the system—in a process known as "thermalization". Equivalently, perpetual motion machines of the second kind are impossible. More simply put: the entropy of the world only increases and never decreases. A watchspring-driven watch will run until the potential energy in the spring is converted, and not again until energy is reapplied to the spring to rewind it. A car that has run out of gas will not run again until you walk 10 miles to a gas station and refuel the car. Once the potential energy locked in carbohydrates is converted into kinetic energy (energy in use or motion), the organism will get no more until energy is input again. In the process of energy transfer, some energy will dissipate as heat. Entropy is a measure of disorder: cells are NOT disordered and so have low entropy. The flow of energy maintains order and life. Entropy wins when organisms cease to take in energy and die.

Energy transformation can make the universe or cell organelles become irregular. Measure of disorder or the randomization process in the universe or inside the cell called entropy. The more random a collection of matter (in the cell) then the greater the value of entropy. The second law of thermodynamics reads every transfer or transformation of energy will increase the entropy of the universe. In many cases that the entropy increase is most evident in the physical damage to the structure of the system, an example of the process of weathering material an increase of entropy in the universe. Other examples such as 25% of the chemical energy stored in the fuel tank

cars used to drive the car, the remaining 75 % is lost as a heat that spread around the machine. Another example is the energy stored in the feed or food teserap in the body is only about 25% of the remaining 25 % is used in the cell and partly go wasted (metabolic waste) which may include CO₂, H₂O, and materials that can not be digested.

The amount of free energy in a system (G), the total energy in the system (H) and entropiya (S), and the absolute temperature (T). The relationship of life energy in a system that is affected by temperature are as follows:

$$G = H - TS \quad \dots(3.2)$$

The temperature will increase entropy due to heating. This is because the temperature diguakan to measure the intensity of motion in molecules located within the cell. Irregularities molecules within the cell would produce a different heat. Not all of the energy stored in the system (H) can be used to do work. So to calculate the maximum capacity of the system to do the job then we need to reduce the total energy as a result of irregularities in the system. In every process that occurs spontaneously in the free energy of the system will be reduced. The change in free energy when the system moves from a particular state to a sufficiently different circumstances described by the equation:

$$\Delta G = G_{\text{final}} - G_{\text{initial}} \text{ or } \Delta G = \Delta H - T\Delta S. \quad \dots(3.3)$$

There is an important relationship between free energy and equilibrium, including chemical equilibrium in the cell. Free energy of a reaction increases when moving away from equilibrium. For the reaction is at equilibrium, then the change in energy is equal to zero because there is no net change (net) system preformance.

Exergonic and endergonic reactions in metabolism. Based on the change of free energy, chemical reactions can be classified as exergonic reaction (which means " energy out ") or endergonic reaction (which means " insert energy "). An exergonic reaction takes place by removing the free energy. Because the chemical mixture loses free energy, ΔG is negative for an exergonic reaction. In other words, exergonic reactions are spontaneous. The magnitude of ΔG for an exergonic reaction is the maximum amount that can be done keja by the reaction. We can use the example of cellular respiration kesuluruhan reaction as follows:

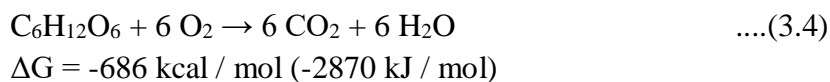

For each mole (180 g) of glucose were overhauled through respiration, resulting or 686 kilocalories (2870 kilojoules) digubakan usual energy to do work (under conditions known to scientists as the standard conditions). Because energy must be conserved, the chemical products of respiration results save a little bit more than 686 kcal of free energy of the reactants. In essence, the result is that the obstruction of energy spent by absorbing most of the free energy stored in sugar molecules.

An endergonic reaction is a reaction that absorbs free energy from its surroundings. Because this type of reaction free energy storing molecule, it adalh positive ΔG . The reaction energy is nonspontan, and large ΔG is the amount of energy required to drive the reaction. If a chemical process is to be exergonic (downhill) adalm one direction, then the opposite should be endergonic (uphill). A reversible process is not going down the hill on the opposite second direction. If $\Delta G = -686$ kcal / mol for respiration, photosynthesis in order to produce sugar from carbon dioxide and water, then it must have a value of $\Delta G = +686$ kcal / mol. The production of sugar in the leaf cells of a plant very endergonic, a hill climbing process is driven by the absorption of solar light energy.

A cell work through three main types of work:

1. Mechanical work, such as the vibration of cilia, contraction of muscle cells and the movement of chromosomes during cellular reproduction.
2. Work Transport, pumping the materials pass through the membrane against the direction of spontaneous movement.
3. Working chemically, pushing endergonic reactions that would not occur spontaneously, such as the synthesis of polymers from monomers.

In most cases, the source of energy which will soon move the mobile workforce is Adenosine triphosphate (ATP). Adenosine triphosphate (ATP) is considered by biologists to be the energy currency of life. It is the high-energy molecule that stores the energy we need to do just about everything we do. It is present in the cytoplasm and nucleoplasm of every cell, and essentially all the physiological mechanisms that require energy for operation obtain it directly from the stored ATP. ATP is able to store and transfer chemical energy within cells. ATP also has an important role in the production of nucleic acids.

1. Structure and Hydrolysis of ATP

ATP molecules are also used to store the material forming the energy produced by cellular respiration. ATP is closely related to the types of nucleotides found in nucleic acids. ATP has the nitrogenous bases adenine ribose -related, such as the adenine nucleotides in RNA. However, in RNA, the ribose phosphate groups associated with. Adenine triphosphate has a Rentai that has three phosphate groups associated with ribose.

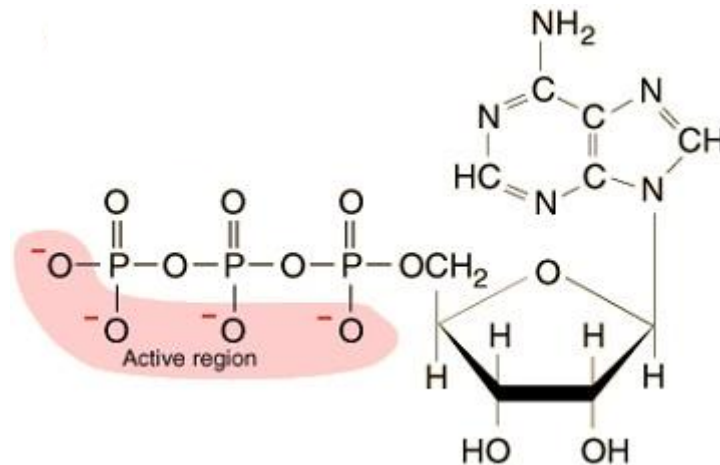
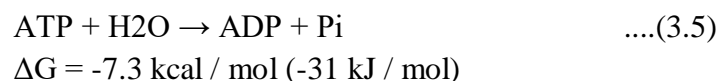

Figure 3.3. Structure of ATP (www.cminstitute.net)

The structure of ATP has an ordered carbon compound as a backbone, but the part that is really critical is the phosphorous part - the triphosphate. Three phosphorous groups are connected by oxygens to each other, and there are also side oxygens connected to the phosphorous atoms. Under the normal conditions in the body, each of these oxygens has a negative charge, and as you know, electrons want to be with protons - the negative charges repel each other. These bunched up negative charges want to escape - to get away from each other, so there is a lot of potential energy here.

Chemically, ATP consists of adenosine and three phosphate groups. $C_{10}H_{16}N_5O_{13}P_3$ empirical formula, chemical formula is $C_{10}H_8N_4O_2NH_2(OH)_2(PO_3H)_3$. Molecular mass is equal to 507 184 u. Phosphorus group that started as a phosphate of AMP -called alpha, beta and gamma. The bond between the phosphate groups of ATP 's tail can be decided through hydrolysis. When the terminal phosphate bond is decided, an inorganic phosphate molecule (abbreviated Pi) then leave the ATP or ADP to adenosine diphosphate. The reaction is exergonic da under laboratory conditions, liberating energy of 7.3 kcal per mole of ATP hydrolyzed:



This is the free energy change is measured at standard conditions. However, the physical and chemical conditions in the cell is not in accordance with the standard conditions. When the reaction occurs dlam cellular environment rather than in a test tube, the actual ΔG is approximately -13 kcla / mol, 78 % greater than the energy produced by the hydrolysis of ATP under standard conditions.

Because hydrolysis liberate energy phosphate bonds of ATP is often referred to as a jga high-energy phosphate bonds, but the term is actually misleading. ATP generally bukanla strong bond, as implied in the term " high-energy " it. In fact, compared to most of the bonds in organic molecules, this bond is relatively weak,

and because the bond is somewhat less stable than hydrolysis produces energy. Hydrolysis products (ADP and Pi) is more stable than ATP. When a system change for the more stable, the change is exergonic. Thus, the release of energy during the hydrolysis of ATP comes from the chemical change toward a more stable state, not from the phosphate bonds themselves. Why are so fragile phosphate bond? If we double-check the ATP molecule, we can know or see that the three negatively charged phosphate groups. Same charges as these can not be calm if clump together, and the charge repulsion between regional instability that might put the ATP molecule. Triphosphate tail of ATP is the chemical equivalence (equality but that is a chemical) with a spring or springs given load.

2. The working mechanism of ATP

When ATP is hydrolyzed in a test tube, the release of free energy is only slightly heat the water around him. In the cell, such circumstances becomes an energy resource use is inefficient and dangerous. With the help of specific enzymes, cells would be able to use energy of ATP hydrolysis directly to endergonic processes by transferring a phosphate group from ATP to some other molecule. Recipient a phosphate group is then called phosphorylated. The coupling is the key to the formation of the phosphorylated intermediates are more reactive (less stable) than the original molecule. Almost all work depends on ATP energizing other molecules to transfer a phosphate group. For example, ATP will move (energize) the muscle movements by transferring phosphate to the muscle contractile proteins.

An organism that uses ATP was working constantly, but ATP is a renewable resource, which can be regenerated with a bunch of how the addition of phosphate to ADP. ATP cycle moving at a very fast pace. For example, a working muscle cell recycles the entire collection of ATP per minute. It describes the rate of change of about 10 million ATP molecules per second that are continuously regenerated by setip cells. If ATP is regenerated through the phosphorylation of ADP, ATP consuming the right human body weighing nearly every day.

For a reversible process can not walk down the hill in both directions, the regeneration of ATP from ADP in principle is endergonic: Strip catabolic (exergonic), especially cellular respiration, provide the energy for endergonic processes for the manufacture of ATP. Plants also use light energy to produce ATP. Thus, the ATP cycle is a revolving door through which energy on the removal of catabolic process to anabolic pathways.

B. Photosynthesis Process

Photosynthesis is the biochemical process of the formation of carbohydrate food substances made by plants, especially plants that contain chlorophyll leaves or chlorophyll. In addition to chlorophyll of plants, living beings other non - chlorophyll are photosynthetic algae and some bacteria. These organisms photosynthesize using nutrients,

carbon dioxide, and water and energy assistance sunlight (photo = light, synthesis = the process of making / processing). Photosynthesis is essential for life on Earth because nearly all living things depend on energy produced by the process of photosynthesis.

Green plants use carbon dioxide, water, and energy from sunlight to make food through photosynthesis. Inside there is a green plant cell organelles called chloroplasts. Chlorophyll contained in the chloroplast. Leaves of plants appear green because chlorophyll absorbs most of the light at a wavelength of light that is visible, except the green light waves. Because most of the wavelength of green light is not absorbed by chlorophyll, it will be reflected by the leaves of plants and is received by our eyes. Light absorbed by chlorophyll provide the energy needed for photosynthesis. Chloroplasts contain pigments other than chlorophyll. These pigments also absorb the rays of sunlight that appear also provide some energy for photosynthesis. When chlorophyll is broken, the leaves will not green plants for a long time. The chlorophyll in the leaves of plants must exist to enable the process of photosynthesis.

Photosynthesis is vital for all aerobic life on Earth because in addition to maintaining normal levels of oxygen in the atmosphere, photosynthesis is also the source of energy for almost all life on Earth, either directly (through primary production) or indirectly (as the main source of energy in their food. Due to the function of photosynthesis can be grouped as follows:

1. The main function of photosynthesis to produce nutrients such as glucose. Glucose is the basic fuel builders other nutrients, the fat and protein in the plant body. These substances into food for animals and humans. Therefore, the ability of plants convert light energy (sunlight) into chemical energy (nutrients) has always been the food chain.
2. Photosynthesis helps clean the air, which reduces the levels of CO₂ (carbon dioxide) in the air because CO₂ is a raw material in the process of photosynthesis. As an end result, in addition to the food substance is O₂ (Oxygen) which is needed for life.
3. The ability of plants to photosynthesize during his lifetime led to the remains of plants that lived past buried in the ground for millions of years to become one of the coal energy sources today.

Plants are autotrophs. Autotrophs means to synthesize food directly from inorganic compounds. Plants use carbon dioxide and water to produce sugar danoksigen necessary as food. The energy for this process comes from photosynthesis. Here is the equation of photosynthesis reaction that produces glucose:

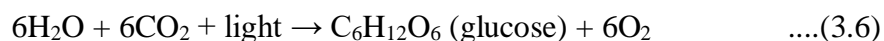

Glucose can be used to form other organic compounds such as cellulose and can also be used as fuel. This process takes place through cellular respiration occurs in both animals and plants. In general, reactions that occur in cellular respiration in contrast to the above equation. On respiration, sugar (glucose) and other compounds will react with oxygen to produce carbon dioxide, water, and chemical energy.

Plants capture light using the pigment called chlorophyll. Pigment is what gives the green color in plants. Chlorophyll contained in organelles called kloroplas.klorofil absorb light to be used in photosynthesis. Although all parts of the body that green plants contain chloroplasts, but the majority of the energy produced in the leaves. In the leaves there is a layer of cells called mesophyll containing half a million chloroplasts per square millimeter. Light will pass through the epidermal layer and the transparent colorless, toward mesophyll, where most of the photosynthesis process. Leaf surface is usually covered by a waxy cuticle that is waterproof to prevent the absorption of sunlight or excessive water evaporation.

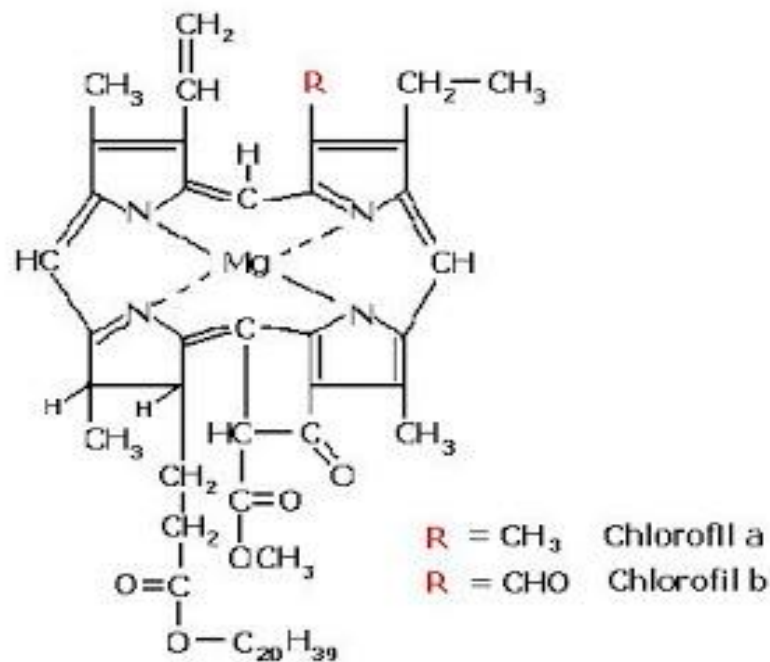

Figure 3.4. structure of Chlorophyll

Sugar is the food produced by the plant. Food that is not directly used by plants, can be stored in the roots, stems, leaves, fruits, and seeds. Sugar made during photosynthesis will be broken down and used to construct other molecules for the plant growth. If sugars are broken down, energy will be generated. The energy produced from the breakdown of sugars is apparently used not only for the needs of the plants but also necessary for the life processes of all living species.

Plants need sunlight, water, and air to produce their own food. Each day, the green substance in plant leaves absorb sunlight. Plants utilize sunlight to carbon dioxide from the air, and water from the soil into food that contains sugar. Plants and release oxygen as a result of unused, although some are used for breathing. For more details see the image below.

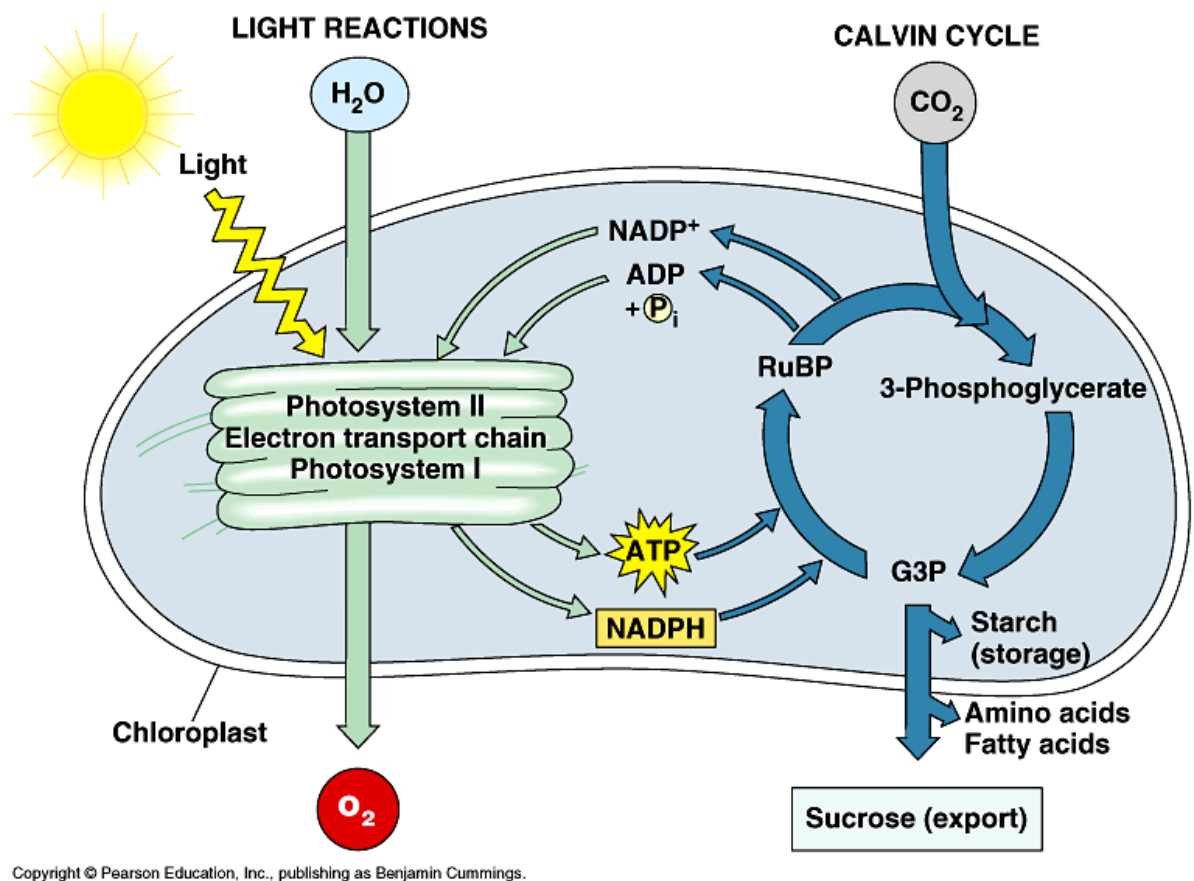

Figure 3.5. Basic photosynthesis (<http://mrskingsbioweb.com>)

In the process of photosynthesis occurs two interrelated reactions, namely:

1. Light reaction

Light reaction is a process that ultimately produces ATP also NADPH₂. In this reaction required the water molecules. Rekais process begins with capturing light photons carried by the pigment chlorophyll which acts as an antenna. In the leaves, the light will be absorbed by chlorophyll molecules and then collected at the reaction centers. Photosynthesis begins when light begin to ionize molecules of chlorophyll and then the release of electrons. Light reaction takes place in the thylakoid membranes in the grana. Grana thylakoid membrane formation is a structure formed in the stroma, which is one room in the chloroplast. In the grana contained chlorophyll, the pigment that plays a role in photosynthesis. Light reaction called photolysis also because the light energy absorption and decomposition of water molecules into oxygen and hydrogen.

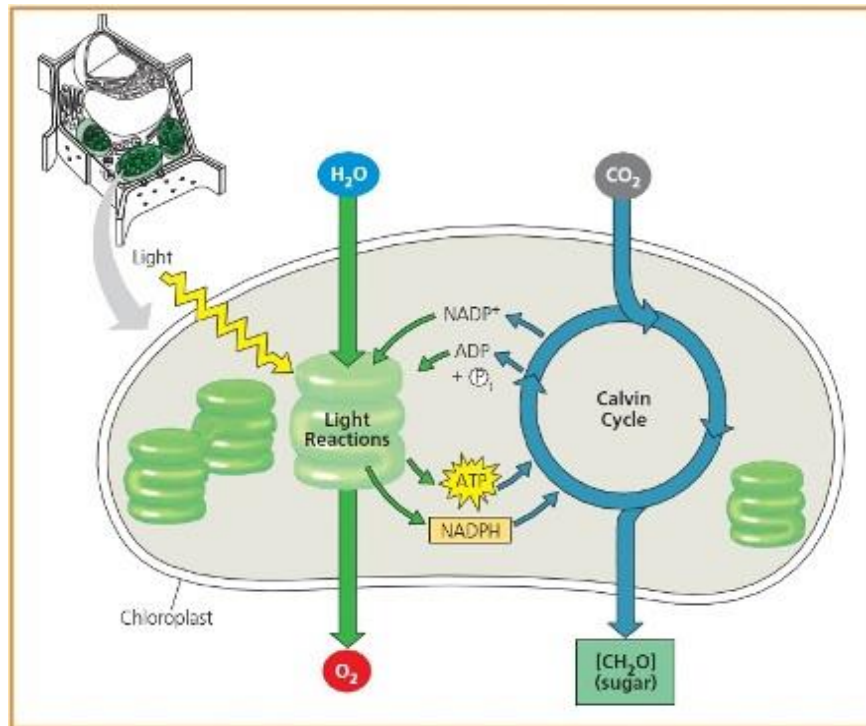

Figure 3.6. Light reaction (<http://www.catatanilmu.com>)

2. Dark reaction

Dark reaction is a process in which ATP and NADPH produced in the previous process and then produce a number of processes or reactions biokimia. Pada own plants, this biochemical reaction will occur calvin cycle where carbon dioxide will be tied up with the aim to form ribose, and will be further glucose. This reaction does not depend on the presence or absence of sunlight. Dark reaction takes place in the stroma. Reaction that forms sugar from raw materials derived CO₂ from the air and energy from the light reactions. Do not need sunlight, but it can not take place if it has not happened because the light cycle energy used is derived from the light reactions.

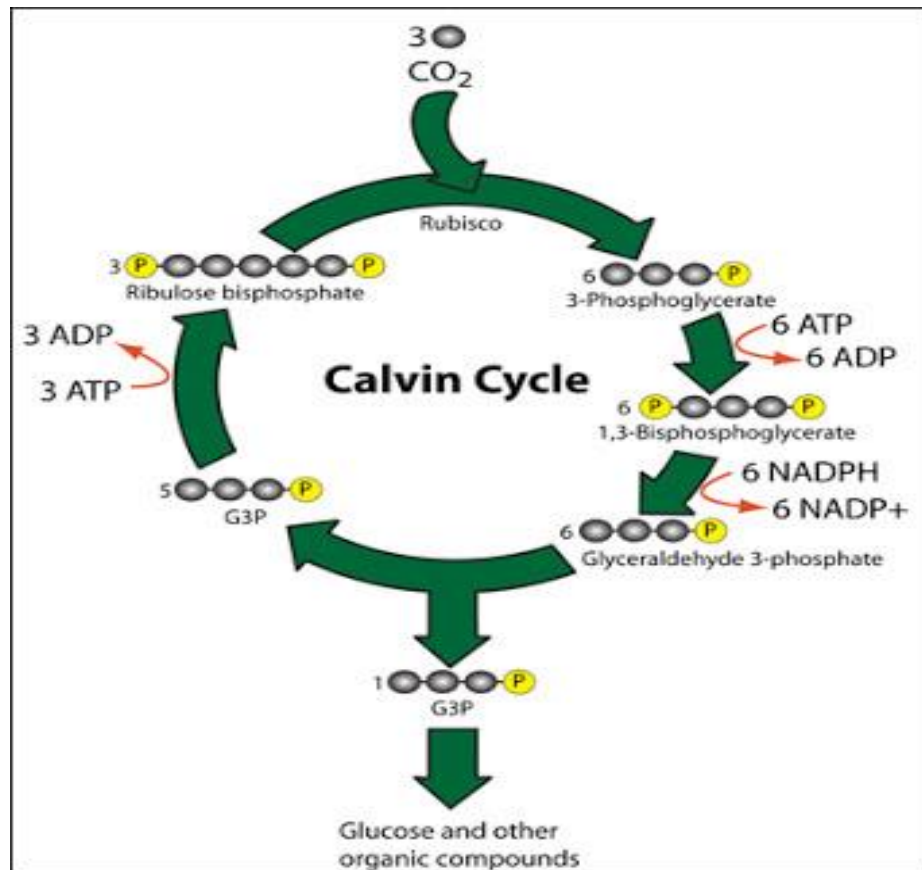

Figure 3.7. Dark reactions (cascadingbooks.blogspot.com)

There are two kinds of cycles, ie Calin - Benson cycle and cycle - Slack hatch. In Calin - Benson cycle, plants produce compounds with carbon atom number three, namely compound 3 - phosphoglycerate. This cycle is aided by enzymes RuBisCo. At hatch - Slack cycle, plants produce compounds with carbon atom number four. Enzyme that plays a role is phosphoenolpyruvate carboxylase. final product obtained glucose dark cycle plant used for activity or stored as energy reserves

C. Carbohydrate Metabolism

Carbohydrate metabolic process broadly consists of two coverage of the cracking reactions or catabolism and anabolism reactions or formation. In the process of formation, one of the elements that must be met is the energy. The energy produced from catabolism. Meanwhile, the metabolic stage itself consists of several parts, namely glycolysis, oxidation of pyruvate to acetyl-CoA, glycogenesis, glycogenolysis, hexose monophosphate shunt and the last is Gluconeogenesis.

Metabolic pathways can be classified into 3 categories:

1. Running anabolic (reunification / formation)

This is the path that is used in the synthesis senyawapembentuk body structure and engine. One example of this category is the synthesis of proteins.
2. Running catabolic (breakdown)

The track includes various oxidation process that releases free energy, usually in the form of high- energy phosphate or equivalently reducing elements, such as the respiratory chain and oxidative phosphorylation.

3. Running amfibolik (intersection)

The track has more than one function and are padapersimpangan metabolism so it works as a liaison between the trajectory of anabolic and catabolic path. An example of this trajectory is the citric acid cycle (Kreb Cycle).

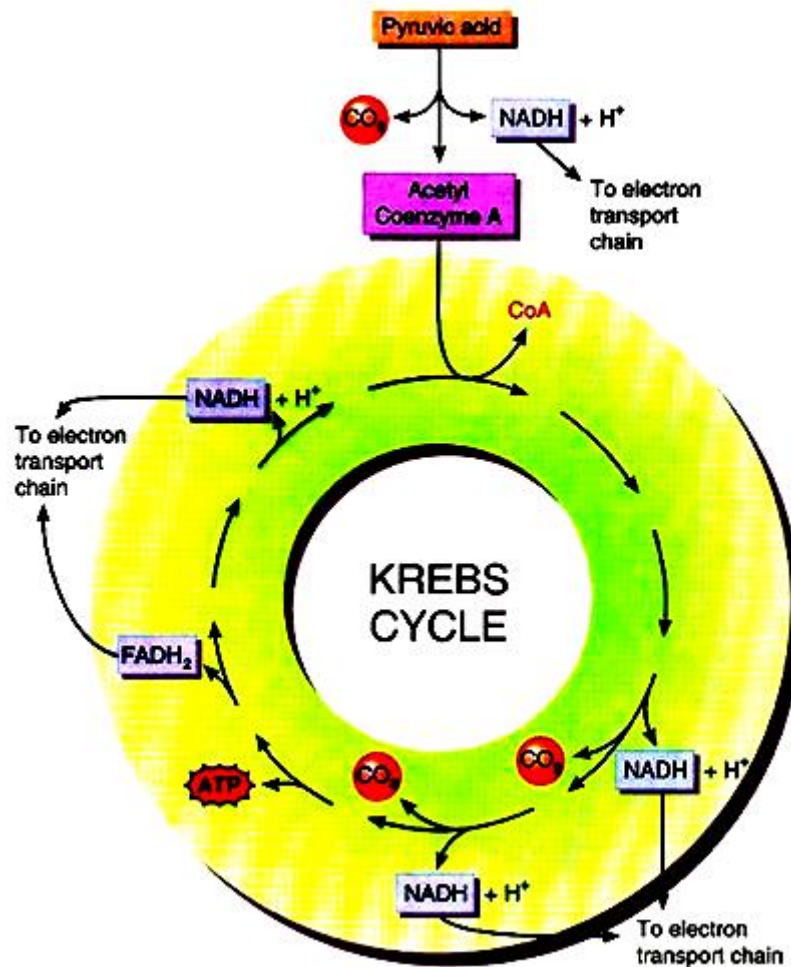

Figure 3.8. Cycle carbohydrate metabolism (<http://apbrwww5.apsu.edu>)

Carbohydrate metabolism in humans can be divided as follows.

1. Glycolysis

Glycolysis is a series of biochemical reactions in which glucose is oxidized to pyruvic acid molecules. Glycolysis is one of the most universal metabolic processes known to us, and occurs (with variations) in many types of cells in nearly all forms of the organism. Glycolysis process itself produces less energy per glucose molecule than aerobic oxidation perfect. The resulting energy is stored in organic compounds such as adenosine triphosphate or more commonly known as ATP and NADH.

The process of glycolysis include oxidation of glucose or glycogen is broken down into pyruvate to lactate also emben road - Meyerhof Pathway or commonly abbreviated as EMP. The process of glycolysis occurs in all networks. The next process is the oxidation of pyruvate to acetic CoA. This step is required prior to the entry of glycolysis results in a cycle of nitric acid which is the end of the road all the components of compound oxidation of proteins, carbohydrates, and fats. Before entering the pyruvic acid nitric acid, it must first be channeled into mitochondria with pyruvate transport special way that helps pasasi pass through the mitochondrial membrane in the area. After arriving in the region of the mitochondria, pyruvate undergo decarboxylation process and processed into acetyl CoA compounds. This decarboxylation process occurs due to the help of thiamine diphosphate derivatives that act as hydroxyethyl thiazole ring and associated with the enzyme. In the event produced pyruvate in aerobic glycolysis, whereas anaerobic glycolysis resulting in lactate via pyruvate. Overall process of glycolysis shown by the schematic in Figure below.

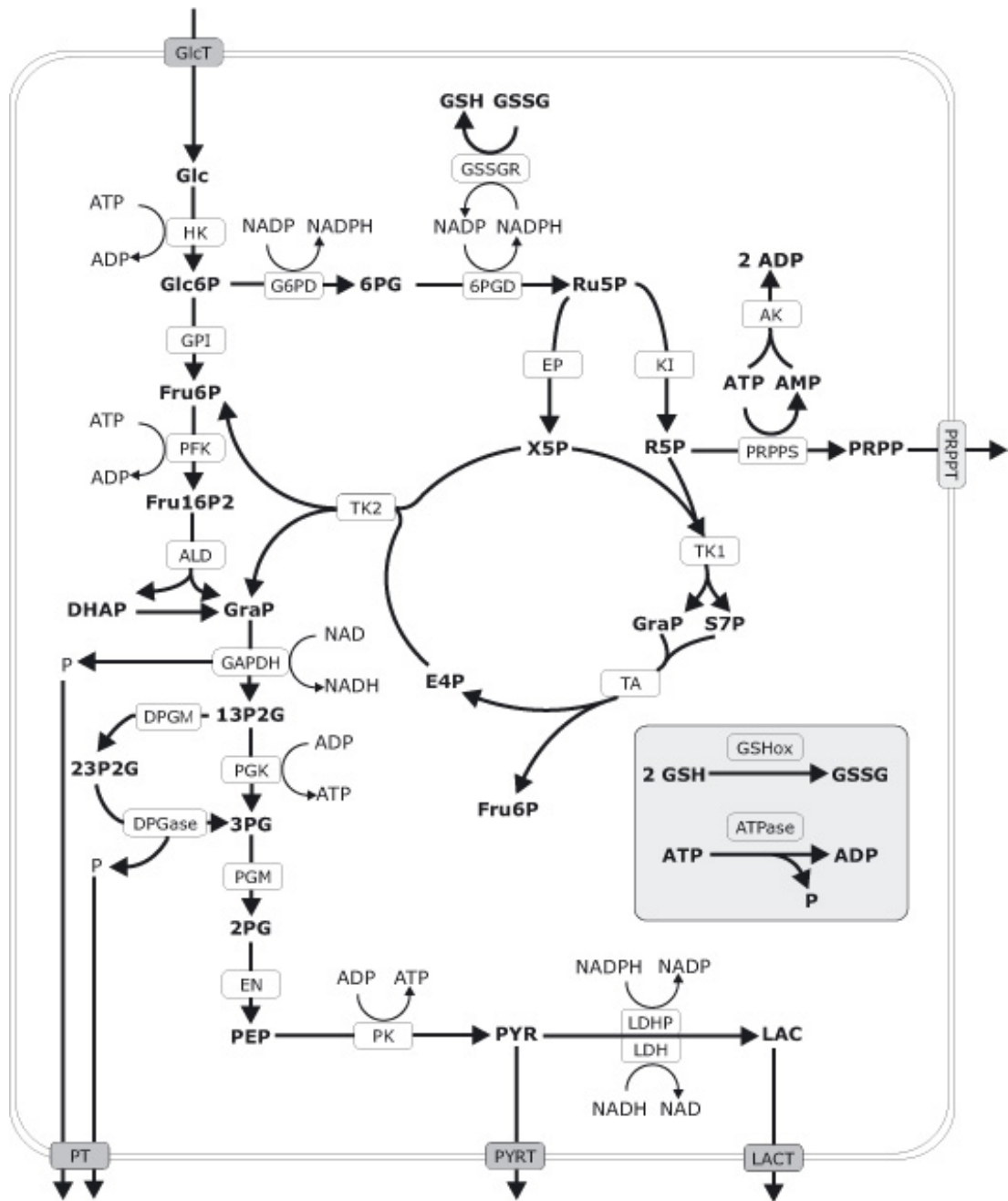

Figure 3.9. Reaction scheme of erythrocyte energy metabolism comprising glycolysis (www.charite.de)

2. Glycogenesis.

Poses the formation of glycogen is glycogenesis from glucose. Glycogen formation process as follows.

- a. The first stage is the formation of glucose - 6 - phosphate from glucose, with the help of the enzyme glucokinase and get extra energy from ATP and phosphate.
- b. Glucose - 6 - phosphate into glucose by the enzyme glukomutase -1- phosphate.

- c. Glucose - 1 - phosphate reacts with UTP (uridine Tri Phosphate) uridyl transferase catalyzed by uridine diphosphate produce glucose (UDP - glucose) and pyrophosphate (PPi).
- d. The last phase condensation between UDP - glucose to glucose glycogen chain number one in the primary generating new glycogen chains with an additional one unit of glucose.

Some terms related to the metabolism of glucose decomposition is as follows:

- a. Fermentation is the process of decomposition or fermentation of glucose without oxygen chemical compounds through a process that results in Glycolysis Pyruvate acid, but did not continue with the Krebs cycle and electron transport due to the reaction atmosphere without oxygen. Pyruvate acid will then be processed without oxygen into pyruvic acid (Acid Fermentation Pyruvate), or pyruvic acid to Acetal dehide later in Fermentation Alcohol. Fermentation produces CO₂.
- b. Glycolysis is the decomposition of carbohydrates to pyruvate.
- c. Glycolysis is a process of anaerobic decomposition of carbohydrates to lactate without involving O₂.
- d. Respiration is the process of a chemical reaction that occurs when cells absorb O₂, producing CO₂ and H₂O. Respiration in a more specific meaning is glucose decomposition processes using O₂, producing CO₂, H₂O, and energy (in the form of chemical energy, ATP) glikosis involving metabolism, Krebs cycle, and oxidative phosphorylase.

3. Gluconeogenesis

Gluconeogenesis is the formation of glucose from pyruvate (reverse glycolysis). The properties of gluconeogenesis events include:

- a. a complex reaction;
- b. involves several enzymes and cell organelles, namely mitokondrion;
- c. first converting pyruvate into malate;
- d. metabolism of pyruvate is transported into the mitokondrion by means active transport through the membrane.

Gluconeogenesis is important to provide glucose, if in the diet does not contain enough carbohydrates. Nerves, the medulla of the kidney, testes, and erythrocyte embriyo networks require glucose as the main source of energy generation. Glucose is needed by adipose tissue to keep the citric acid cycle intermediates. In mammary, glucose needed to make lactose. In muscle, glucose is the only energy in the material to form anaerobic conditions.

To cleanse the blood of lactic acid which is always made by the red blood cells and muscles, and also glycerol fatty tissue removed, we need a process or pathway that can utilize them. In ruminant animals, propionic acid is the main ingredient for gluconeogenesis. Gluconeogenesis pathway is used in the modification and adaptation of the Embden - Meyerhof pathway and the citric acid cycle.

Additional enzymes are required in this process apart from the enzymes in the two lines above are:

a. pyruvate carboxylase

In the fasting state, the enzyme pyruvate carboxylase and phosphoenolpyruvate karboksikinase enzyme synthesis increased. The synthesis of these enzymes is also affected by glucocorticoid hormones. In the fasting state, fatty acid oxidation in the liver is increased. It carries a favorable result for gluconeogenesis because it will generate ATP, NADH and oxaloacetate.

Fatty acid and acetyl - CoA would inhibit enzymes phosphofruktokinase, pyruvate kinase and pyruvate dehydrogenase, activates enzymes pyruvate carboxylase and fructose 1,6 - bisfosfatase.

b. Substrate for gluconeogenesis is:

- 1) lactic acid from the muscles, red blood cells, the medulla of the supra - renal gland, the retina and bone marrow
- 2) glycerol, which is derived from fat tissue
- 3) propionic acid, which is produced in the process of digestion in ruminant animals.
- 4) amino acids glikogenik

c. Changes in lactic acid to glucose

Lactic acid in the cytoplasm is converted to pyruvic acid, pyruvic acid and then into the mitochondria and is converted into oxaloacetate. Because oxaloacetate can not pass through the membrane mitochondria, it is converted first into malate. In cytoplasmic malate is converted back to oxaloacetate. Oxaloacetate is then converted into phosphoenolpyruvate which then runs toward the Embden - Meyerhof pathway opposite and would eventually become glucose.

EXERCISE

To improve your understanding of the material above, do the exercises below!

- 1) Explain what is the difference in metabolism between the events of anabolism and catabolism!
- 2) Explain what the role of adenosine triphosphate (ATP) in the body system!
- 3) Explain what is the difference between dark reaction and light reaction during photosynthesis?
- 4) Explain what is meant by the process of glycolysis?
- 5) Explain what the benefits of the process of Gluconeogenesis!

Instructions to Answer Exercise

If you have difficulty in answering the questions above consider the answers below as a reference.

- 1) Metabolism includes the process of synthesis (anabolism) and the decomposition (catabolism) compounds or components in living cells.. Anabolism to catabolism distinguished in several respects:
 - a) Anabolism is the process of chemical synthesis of small molecules into larger chemical molecules, while catabolism is the decomposition of large molecules into smaller molecules
 - b) Anabolism is the process requires energy, while releasing energy catabolism
 - c) Anabolism is a reduction reaction, an oxidation catabolism
 - d) The final result is a compound anabolism to catabolism beginners.
- 2) Adenosine triphosphate (ATP) is a nucleotide known in biochemistry as the world substance most responsible for intracellular energy transfer. ATP is able to store and transfer chemical energy within cells. ATP also has an important role in the production of nucleic acids. ATP molecules are also used to store the material forming the energy produced by cellular respiration.
- 3) light reaction is a process that ultimately produces ATP also NADPH_2 . In this reaction required the water molecules. Rekais process begins with capturing light photons carried by the pigment chlorophyll which acts as an antenna. In the leaves, the light will be absorbed by chlorophyll molecules and then collected at the reaction centers. While the dark reaction takes place in the stroma. Reaction that forms sugar from raw materials derived CO_2 from the air and energy from the light reactions. Do not need sunlight, but it can not take place if it has not happened because the light cycle energy used is derived from the light reactions.
- 4) Glycolysis is a series of biochemical reactions in which glucose is oxidized to pyruvic acid molecules. Glycolysis is one of the most universal metabolic processes known to us, and occurs (with variations) in many types of cells in nearly all forms of the organism. Glycolysis process itself produces less energy per glucose molecule than aerobic oxidation perfect. The resulting energy is stored in organic compounds such as adenosine triphosphate or more commonly known as ATP and NADH.

Gluconeogenesis is important to provide glucose, if in the diet does not contain enough carbohydrates. Nerves, the medulla of the kidney, testes, and erythrocyte embriyo networks require glucose as the main source of energy generation. Glucose is needed by adipose tissue to keep the citric acid cycle intermediates. In mammary, glucose needed to make lactose. In muscle, glucose is the only energy in the material to form anaerobic conditions.

RESUME

Metabolism includes the process of synthesis (anabolism) and the decomposition (catabolism) compounds or components in living cells. All metabolic reactions catalyzed by enzymes. Another thing that is important is its role in the metabolism or detoxification penawaracunan, namely the conversion reaction mechanism of toxic substances into non-toxic compounds that can be excreted from the body. Energy is the basis of all metabolic processes so as to understand metabolic processes need to be understood first about energy. Energy for various functions of the human body comes from nutrient molecules that have been metabolized.

Energy transformation processes in biological systems can be divided into the following three processes: (1) The transformation of energy by chlorophyll, sunlight radiation energy is captured by chlorophyll is then converted into chemical energy through photosynthesis, chemical energy is then used to synthesize CO_2 and H_2O into glucose and other complex compounds as binding energy and the coupling nuclei stored in the form of carbohydrate compounds (as food), (2) the transformation of energy by mitochondria, where chemical energy is used to convert carbohydrates and other compounds as energy phosphate bonds through cellular respiration for the oxidation of DNA, RNA, proteins, and fats, (3) Transformation of energy by the cell, when the cell activity, the chemical energy of the phosphate bond will be separated and transformed into other forms of energy such as mechanical energy for muscle contraction work, electrical energy to continue the impulse nerve, energy synthesis for building compound growth, and the rest will flow around the cell and energy is lost as heat.

Photosynthesis is vital for all aerobic life on Earth because in addition to maintaining normal levels of oxygen in the atmosphere, photosynthesis is also the source of energy for almost all life on Earth, either directly (through primary production) or indirectly (as the main source of energy in their food).

CHAPTER 4

PROTEIN STRUCTURE

Within two days after the initial publication of Wilhelm Röntgen's discovery of X rays in 1895, a surgeon in Scotland used X rays to observe a needle as he extracted it from the palm of an unfortunate seamstress. Although this medical application resulted in the development of radiological diagnosis and treatment of disease by radiation, physical aspects of Röntgen's discovery also provided the means for elucidating the structure of proteins and other large molecules. The laws governing the diffraction of X rays were discovered by the two Braggs, Sir William and Sir Lawrence, who were father and son. At the Cavendish Laboratory at the University of Cambridge, where Sir Lawrence was professor, J.D. Bernal was studying the use of X-ray diffraction for the determination of the structure of large biological molecules. He had already used X rays to define the size and shape of the tobacco mosaic virus and showed it to have a regular internal structure. At the Cavendish Laboratory the group that formed around Bernal, a man of wide public and scientific interests, included the Nobel Prize winners Max Perutz and John Kendrew, who in 1937 began to use X rays to analyze two proteins fundamental to life, myoglobin and hemoglobin, both of which function in the transport of gases in the blood. Twenty-two years passed before the structures of these proteins were established; the significance of the work is that it provided the basis for an understanding of the mechanism of the action of enzymes and other proteins, an active and fruitful subject of modern investigation.

The word protein comes from the Greek *proteios* which means "first row". Word coined by Jons J. Barzelius in 1938 to emphasize the importance of this group. The structure of proteins is a biomolecular structure of a protein molecule. Each protein, in particular polypeptide is a polymer which is made up of a sequence of L - α - amino (this sequence is also referred to as the residue). The deal, a chain length less than 40 residues referred to as a polypeptide, not a protein.

Protein plays an important role in almost all biological processes. A protein is a functional biological molecule that is made up of one or more polypeptides that are folded/coiled into a specific structure. Proteins are important macromolecules that serve as structural elements, transportation channels, signal receptors and transmitters, and enzymes. Proteins are linear polymer that are built up of the monomer units called amino acids. There are 20 different amino acid and they are connected by a peptide bond between the carboxyl group and the amino group in a linear chain called a polypeptide. Each protein has different side chains or the "R" groups. Proteins have many different active functional groups attached to them to help define their properties and functions.

Proteins cover a wide range of functions, ranging from very rigid structural elements to transmitting information between cells. Each person has several hundred thousands of different proteins in their body. Proteins are essential components or major components of animal or human cells. Therefore it is forming cells of our body, the protein contained in the food serves as a major agent in the formation and growth of the body. To be able to perform biological functions, proteins fold into one or more specific spatial conformations, driven by a number of non - covalent interactions such as hydrogen bonding, ionic interactions, van der

Waals forces, and hydrophobic packing system. Protein three-dimensional structure is necessary to understand the function of proteins at the molecular level.

Protein structures vary in size, from tens to thousands of residues. Proteins are classified based on their physical size as nanoparticles (1-100 nm). A protein can undergo reversible structural changes in biological function. Alternative structures of the same proteins referred to as conformation.

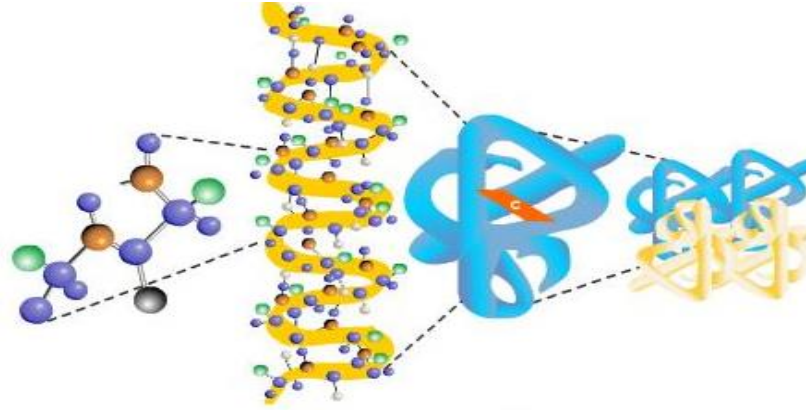

Figure 4.1. Protein structure

Plants form a protein of CO₂, H₂O, and nitrogen compounds. Animals that eat plants alter plant protein into animal protein. In addition to be used for the formation of the body's cells. Protein is also used as a source of energy when our body deficiency of carbohydrates and fats. Average composition of chemical elements contained in the protein are as follows: Carbon 50% , 7% hydrogen, 23% oxygen, 16% nitrogen, 0.3% sulfur, and phosphorus 0.3% .

Amino acids are the basic structural units of proteins. A - amino acid consists of an amino group, carboxyl group, and the H atoms that are all specific R groups attached to the carbon. The carbon atom is called as adjacent to the carboxyl group (acid). Group R represents a side chain.

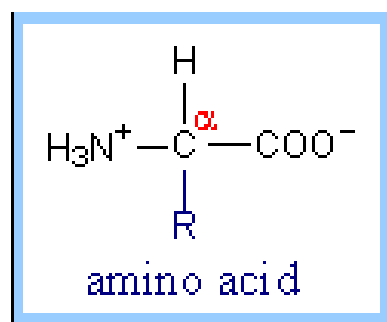

Figure 4.2. The structure of the amino acids.

Amino acid solutions at neutral pH is primarily a dipolar ion (zwitterion), not unionized molecules. Dipolar form, the amino group is in the form of protons and carboxyl group in the form of dissociation. Ionization of an amino acid status varies depending on the pH. In acidic solution (eg, pH 11), the carboxyl group in the form of unionized and ionized amino group in the form. In alkaline solution (eg pH 1) in the form of ionized carboxyl group and an amino

group in the unionized form (-NH₂). Have glycine carboxyl group pK of 2.3 and pK amino groups of 9.6. Thus, the midpoint of the first ionization is at pH 2.3 and for the second ionization at pH 9.6.

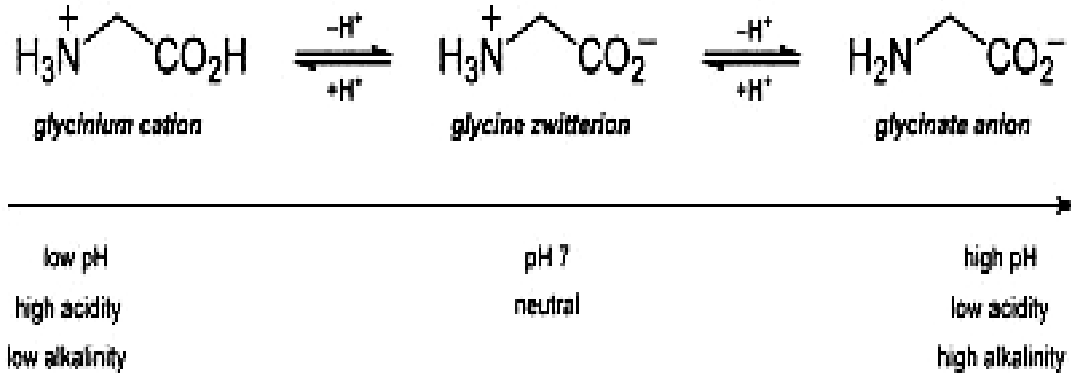

Figure 4.3. Ionization state of amino acids depends on the pH (en.wikipedia.org).

Tetrahedral arrangement of four different groups on the carbon atoms of amino acids has led to the optical activity. Two mirror image forms called isomers of L and D isomers. Proteins consist of amino acids L, so the sign of the optical isomers can be ignored in the discussion and subsequent protein amino acids in question are L isomers, unless there is an explanation.

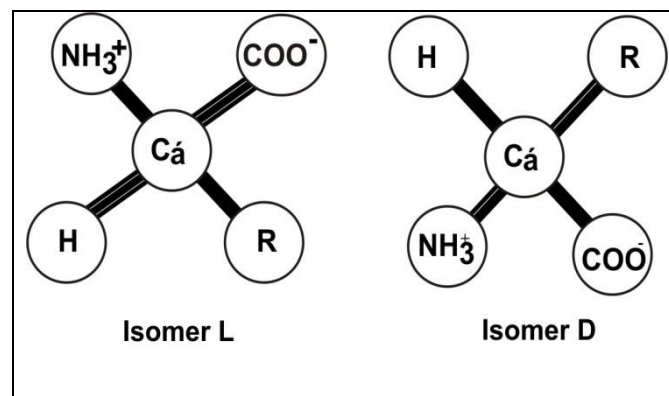

Figure. 4.4. Absolute configuration of the amino acid L -isomers and D. R describe the side chain. L and D isomers are mirror images.

Generally, the protein was found 20 types of side chains that vary in size, shape charge, hydrogen bonding capacity and chemical reactivity. The composition of the proteins in all species ranging from bacteria to humans formed from the same 20 amino acids and has never changed during evolution. Diversity function is mediated by protein diversity made possible by arrangement made of 20 types of amino acids as building blocks.

The simplest amino acid is glycine, which has only one hydrogen atom as a side chain (Figure 4.4). The following amino acids are alanine, with a methyl group as a side chain. Hydrocarbon side chains larger (three and four carbons) found in valine, leucine and isoleucine. Aliphatic side chains are larger hydrophobic, water-repellent and tend to form groups. As will be discussed later, the three-dimensional structure of a protein that is soluble in water would be stabilized by the hydrophobic side chains are flocking to avoid contact with the water. Differences in size and shape of the hydrocarbon side chain allows the protein to form a structure that is concise and compact holes.

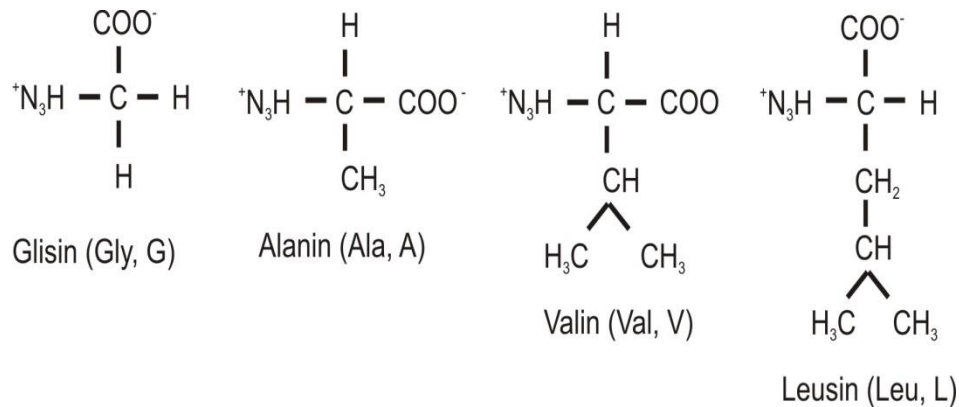

Figure 4.5. Amino acids with aliphatic side chains.

A. Protein Structure

Proteins fold into secondary, tertiary, and quaternary structures based on intramolecular bonding between functional groups or intermolecular bonding (quaternary only) and can obtain on a variety of three-dimensional shapes depending on the amino acid sequence. All proteins have primary, secondary and tertiary structures but quaternary structures only arise when a protein is made up of two or more polypeptide chains. The folding of proteins is also driven and reinforced by the formation of many bonds between different parts of the chain. The formation of these bonds depends on the amino acid sequence. The study of their structures is important because proteins are essential for every activity in the human body as well as they are the key components of biological materials. Primary structure is when amino acids are linked together by peptide bonds to form polypeptide chains. Secondary structure is when the polypeptide chains fold into regular structures like the beta sheets, alpha helix, turns, or loops. A functional protein is much more than just a polypeptide, it is one or more polypeptides that have been precisely folded into a molecule with a very specific, unique shape which is critical to its function.

The primary structure is the sequence of amino acids. Secondary structure associated with the setting position space adjacent amino acid residues in the linear sequence. This steric arrangement gives the periodic structure. Helix - and strand - show secondary structure. Tertiary structure depicting spatial arrangement of amino acid residues far apart in the linear sequence and pattern sulfide bonds. The difference between the secondary

structure and tertiary structure is less clear. In addition, the presence of well known quaternary structures and structures that will be discussed at a glance supersekunder in this section.

1. Primary structure

In 1953, Frederick Sanger determines the amino acid sequence of insulin, a protein hormone. This is an important event for the first time show unequivocally that the protein having the amino acid sequence of a particular right. Amino acid sequence is then known as the primary structure. The primary structure of a protein is the level of protein structure which refers to the specific sequence of amino acids. When two amino acids are in such a position that the carboxyl groups of each amino acid are adjacent to each other, they can be combined by undergoing a dehydration reaction which results in the formation of a peptide bond.

Amino acids in a polypeptide (protein) are linked by peptide bonds that begin with the N-terminal with a free amino group and ends at C-terminal with a free carboxyl group. The peptide bond is planar and cannot rotate freely due to a partial double bond character. While there is a restricted rotation about peptide bond, there are two free rotations on (N-C) bond and (C-C) bond, which are called torsion angles, or more specifically the phi and psi angles. The freedoms of rotation of these two bonds are also limited due to steric hindrance. Genes carry the information to make polypeptides with a defined amino acid sequence. An average polypeptide is about 300 amino acids in length, and some genes encode polypeptides that are a few thousand amino acids long.

It's important to know the primary structure of the protein because the primary structure encodes motifs that are of functional importance in their biological function; structure and function are correlated at all levels of biological organization. It is also shown that insulin is composed of only L amino acids that are interconnected via a peptide bond between amino - and carboxyl group - achievement stimulate other researchers to study the amino acid sequences of various proteins. Currently known complete amino acid sequence of more than 10,000 proteins. A striking fact states that each protein has a unique amino acid sequence with the sequence of very precise.

In proteins, the carboxyl group of amino acids bound to the amino group of the other amino acids by peptide bonds (also called an amide bond). In the formation of a dipeptide from two amino acids occurred spending one water molecule can be seen in Figure 2.5. The reaction equilibrium toward hydrolysis is not in synthesis. Therefore, the biosynthesis of peptide bonds requires free energy, otherwise hydrolysis of peptide bonds are thermodynamically exergonic.

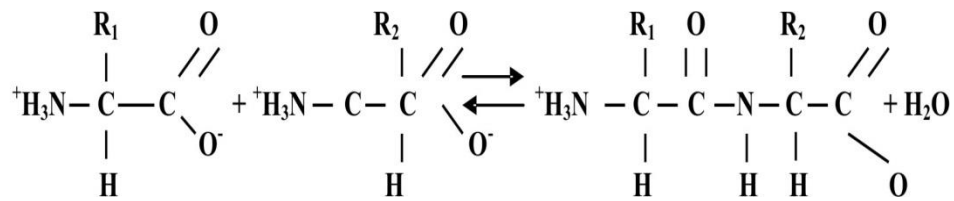

Figure 4.6. Peptide bond formation.

Many amino acids bonded by peptide bonds to form polypeptide chains are not branched (Figure 2.7). One unit of amino acid residues in a polypeptide chain called. Because the direction of the polypeptide chain has constituent units have different ends, namely amino - and carboxyl - groups. Under the agreement, the amino end of the polypeptide chain is placed at the beginning; meaningful sequence of amino acids in a polypeptide chain are written with prefixed by aminoterminal residue. In a tripeptide Ala - Gly - Trp (AGW), alanine is a residue aminoterminal and Tryptophan are carboxyl - terminal residues. It should be noted that the Trp - Gly - Ala (WGA) is a tripeptide that is different.

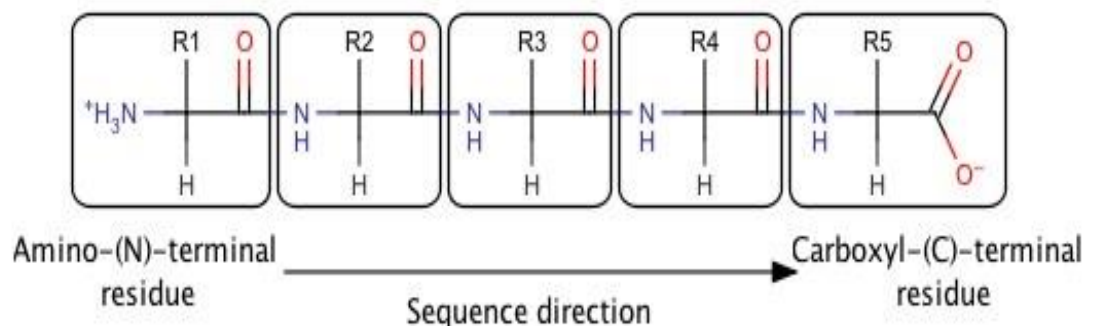

Figure 4.7. Amino acid residues contained in the box, chain starting at the amino end.

Polypeptide chains composed of repeating sections uniformly called the main chain, and parts that make up a variable side chain (C). The main chain is sometimes called the backbone. Most of the polypeptide chain in nature containing between 50 and 2000 amino acid residues. Average molecular weight of amino acid residues is 110, mean molecular weight polypeptide chains is between 5,500 and 220,000. Protein mass can also be expressed in daltons; dalton equals one atomic mass unit. A protein with a molecular weight of 50,000 has a mass of 50 kd (kilodalton).

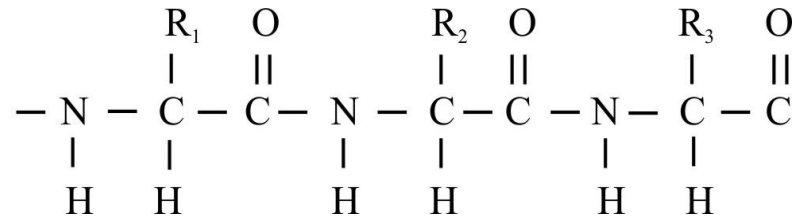

Figure 4.8. Polypeptide chain is formed from main chain repeated on a regular basis (spine) and the side chains of certain (R1, R2, R3 are colored yellow).

A number of proteins have disulfide bonds. Antarrantai disulfide bonds in the chain and is formed by oxidation of cysteine residues. Are generated cysteine disulfide (Figure 4.8). Intra- cell proteins generally do not have disulfide bonds, whereas extracellular proteins often have several. Non cross - sulfur bond derived from lysine side chains are found in several proteins. For example, the collagen fibers in the connective tissue is strengthened in this way, just as fibrin in blood collection.

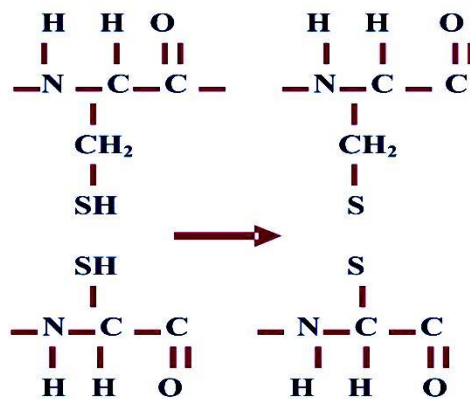
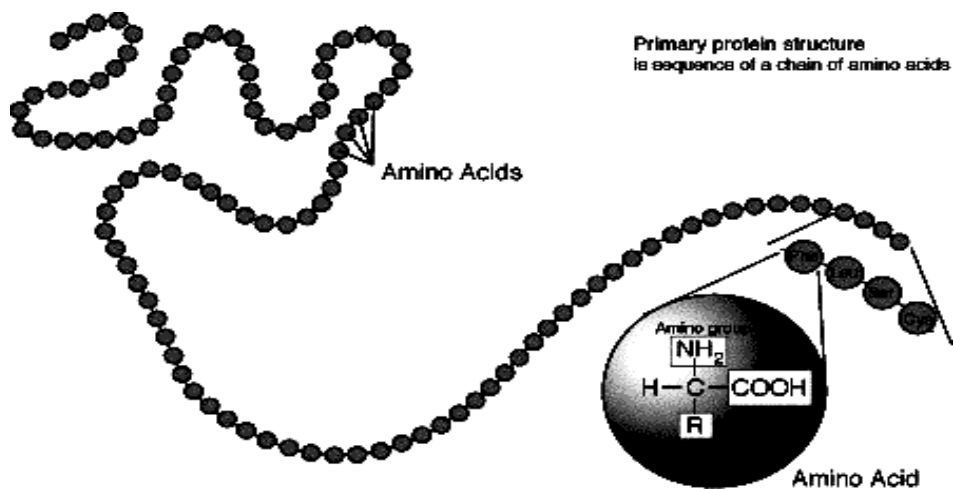

Figure 4.9a. Disulfide bridge (- SS -) formed from the sulfhydryl group (- SH) of two cysteine residues and will produce a cystine residue.



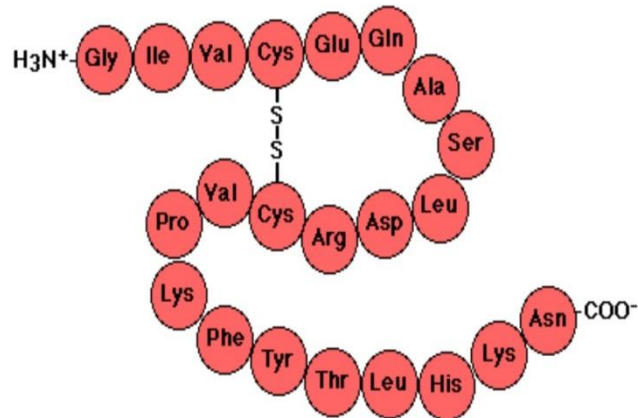

Figure 4.9b Model sulfide bonds in the primary structure.

2. Secondary structure

The amino acid sequence of a polypeptide, together with the laws of chemistry and physics, cause a polypeptide to fold into a more compact structure. Amino acids can rotate around bonds within a protein. This is the reason proteins are flexible and can fold into a variety of shapes. Folding can be irregular or certain regions can have a repeating folding pattern. The coils and folds that result from the hydrogen bonds between the repeating segments of the polypeptide backbone are called secondary structures. Although the individual hydrogen bonds are weak, they are able to support a specific shape for that part of the protein due to the fact that they are repeated many times over a long part of the chain. Secondary structures of a protein are proposed by Pauling and Corey. Its structures are formed by amino acids that are located within short distances of each other. Because of the planar nature of the peptide bonds, only certain types of secondary structure exist. The three important secondary structures are α -helix, β -sheets, and β -turns. Also, the beta sheets can be parallel, antiparallel, or mixed. Antiparallel beta sheets are more stable because the hydrogen bonds are at a right angle. The α -helix is a coiled structure stabilized by intrachain hydrogen bonds.

Pauling and Corey polypeptide conformation study various possibilities to create molecular models. They very obey observations bond angles and distances on amino acids and small peptides. In 1951, they revealed two polypeptide structure called helix and pleated sheets. This structure is related to the setting position of the amino acid residues of space in a linear sequence.

Characteristics of the Secondary Structures (http://en.wikibooks.org/wiki/Structural_Biochemistry/Proteins):

1. **α -helix:** In an α -helix, the polypeptide backbone forms a repeating helical structure that is stabilized by hydrogen bonds between a carbonyl oxygen and an amine hydrogen. These hydrogen bonds occur at regular intervals of one hydrogen bond every fourth amino acid and cause the polypeptide backbone to form a helix. The

most common helical structure is a right-handed helix with its hydrogen bonds parallel to its axis. The hydrogen bonds are formed between carbonyl oxygen and amine hydrogen groups of four amino acid residues away. Each amino acid advances the helix, along its axis, by 1.5 Å. Each turn of the helix is composed of 3.6 amino acids; therefore the pitch of the helix is 5.4 Å. There is an average of ten amino acid residues per helix with its side chains orientated outside of the helix. Different amino acids have different propensities for forming α -helix, however proline is a helix breaker because proline does not have a free amino group. Amino acids that prefer to adopt helical conformations in proteins include methionine, alanine, leucine, glutamate and lysine (malek).

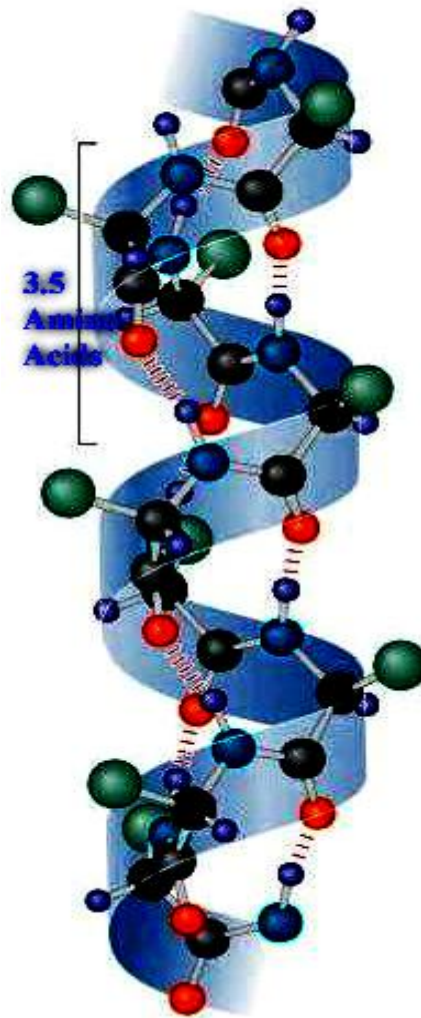

Figure 4.10. α Helix (en.wikibooks.org)

2. **β -sheet:** β -sheets are stabilized by hydrogen bonding between peptide strands. In a β -sheet, regions of the polypeptide backbone come to lie parallel to each other and are connected by hydrogen bonds. The hydrogen bonds are formed between the carbonyl oxygen and the amine hydrogen of amino acid in adjacent strands in a polypeptide, which means that the hydrogen bonds are inter-strand. β -sheet regions

are more extended than an α -helix, and the distance between adjacent amino acids is 3.5 Å. Hydrogen bonding in β -strand can occur as parallel, anti-parallel, or a mixture. Amino acid residues in β -parallel configuration runs in the same orientation. Pleated sheets makes up the core of many globular proteins and also are dominant in some fibrous proteins such as a spiders web. The large aromatics such as: tryptophan, tyrosine and phenylalanine, and beta-branched amino acids like: isoleucine, valine, and threonine prefer to adopt β -strand conformations. This orientation is energetically less favorable because of its slanted, non-vertical hydrogen bonds. Tryptophan, tyrosine, and phenylalanine are hydrophobics while the other amino acids are hydrophilics.

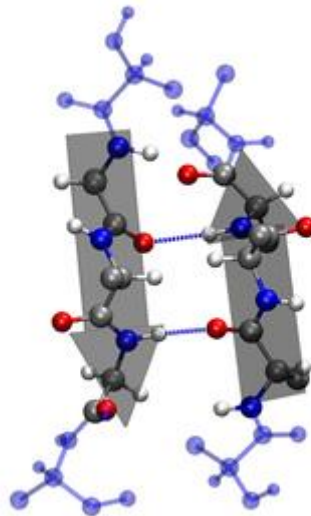

Figure 4.11. Another type of secondary structure, a beta sheet (en.wikibooks.org)

3. **β -turns:** Poly peptide chains can change direction by making reverse turns and loops. Loop regions that connect two anti-parallel β -strands are known as reverse turns or β -turns. These loop regions have irregular lengths and shapes and are usually found on the surface of the protein. The turn is stabilized by hydrogen bond between the backbone of carbonyl oxygen and amine hydrogen. The CO group of the residue, in many reverse turns, which is bonded to the NH group of residue $i + 3$. The interaction stabilizes abrupt changes in direction of the polypeptide chain. Unlike the alpha-helices and β -strands, loops do not have regular periodic structures. However, they are usually rigid and well defined. Since they loops lie on the surface of the proteins, they are able to participate in interactions between proteins and other molecules. Ramachandran plot is a plot that shows the available torsion angles of where proteins can be found. However, in the plot, if there are many dots that locate all over the place, it means that there exists a loop.

Helical form stabilized by hydrogen bonds between the NH group and the CO group in the main chain. CO group of each amino acid to form hydrogen bonds with the NH groups of amino acid residues located at the four in front of him in a linear

sequence. Means all the CO group and the main chain NH groups form hydrogen bonds. Each subsequent acid residues with residues along the helical axis of Figure 2.10. Helix has a range of 1.5 to 100° rotation, so that there are 3.6 amino acid residues per helical twist.

In helical amino acids within three and four will be located in a linear sequence in the opposite helix so not interconnected. The distance between the two helical twist is multiplication translational distance (1.5) and the number of residues in each round of the same 3.6 to 5.4. Helical twist direction as the screw can be turn right (clockwise) and turn left (counter clockwise) rotating helical proteins are right. Helical content of the protein varies widely from almost nothing to 100% . For example, the enzyme chymotrypsin contains no helix. In contrast, 75% protein myoglobin and hemoglobin helical. The length of single-stranded helix is usually less than 45. But two or more helices can spiral into each other to form a stable structure, the length can reach 1000 (100 nm or 0.1 m) or more. Helical twisting each myosin and tropomyosin found in muscle, fibrin clots in blood and in hair keratin. The helical shape of the protein has a role in the formation of mechanically rigid fiber bundle such spikes. Cytoskeleton (inner buffer) a cell containing many filaments which are the two strands of the helix spiral into each other.

Helical structure was deduced by Pauling and Corey six years before the structure is evident in myoglobin by using X-ray examination The description of the helical structure is an important event in the history of molecular biology because it shows that the conformation of the polypeptide chain can be predicted if the known properties of its components carefully and precisely.

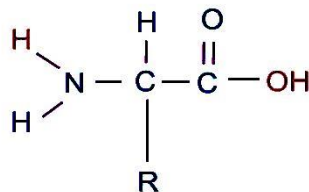

Figure 4.11. The main structure of amino acids.

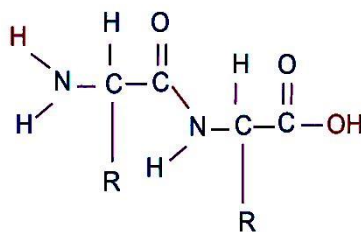

Figure 4.12. Ribbon peptide.

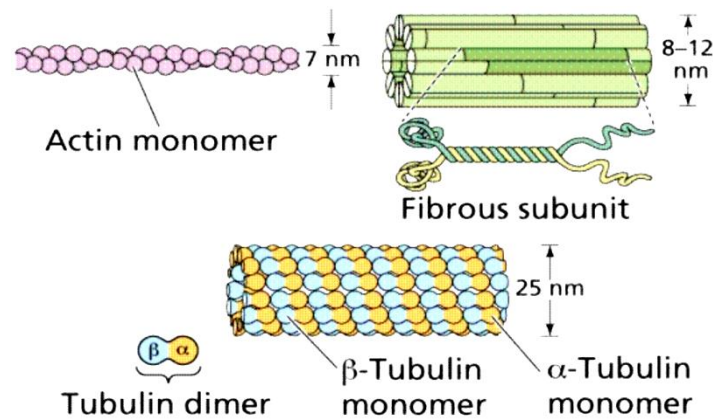

Figure 4.13. The structure of the helix spiral.

Pauling and Corey find another mode of periodic structures called pleated sheet (so-called because it is the structure that they found while the second helix as the first structure). Pleated sheets are different from a helical rod-shaped. Polypeptide chain pleated sheet called a strand, straight shape is not stretched taut like a coiled helix. Axis distance between adjacent amino acids is 3.5 Å, while the helix is 1.5 Å. Another difference is that the pleated sheets are stabilized by hydrogen bonds between NH and CO groups on different polypeptide chains, whereas the helix there are hydrogen bonds between NH and CO groups on the same chain.

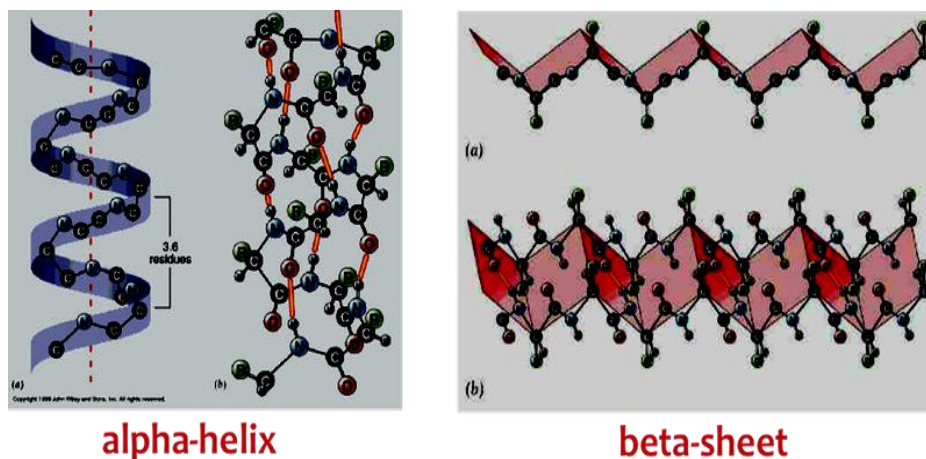

Figure 4.14. R. pleated sheet

Polypeptide chains adjacent to the pleated sheet can be unidirectional (parallel sheet) or opposite directions (antiparallel sheets). For example, silk fibroin is composed almost entirely of antiparallel sheet piles. This sheet is a part of a repeating structure in many proteins. Frequently encountered structural unit consisting of two to five sheets of parallel or antiparallel strands.

3. Tertiary structure

Tertiary structure depicting spatial arrangement of amino acid residues far apart in the linear sequence and the pattern of disulfide bonds. The difference between the secondary and tertiary structure is less clear (see Figure 4.15). Collagen shows a special type of a helix and is the most abundant protein found in mammals. Collagen is the main component of the fiber in the skin, bones, tendons, cartilage and teeth. This extracellular protein containing three helical polypeptide chains, each of which is along the nearly 1000 residues. The sequence of amino acids in collagen are very irregular: every third residue is nearly always glycine. Compared with other proteins in the collagen content of proline is also high. Furthermore, collagen -containing 4 - hydroxyproline are rarely found in other proteins. Sequence glycine - proline - hydroxyproline (Gly - Pro - Hyp) is often encountered.

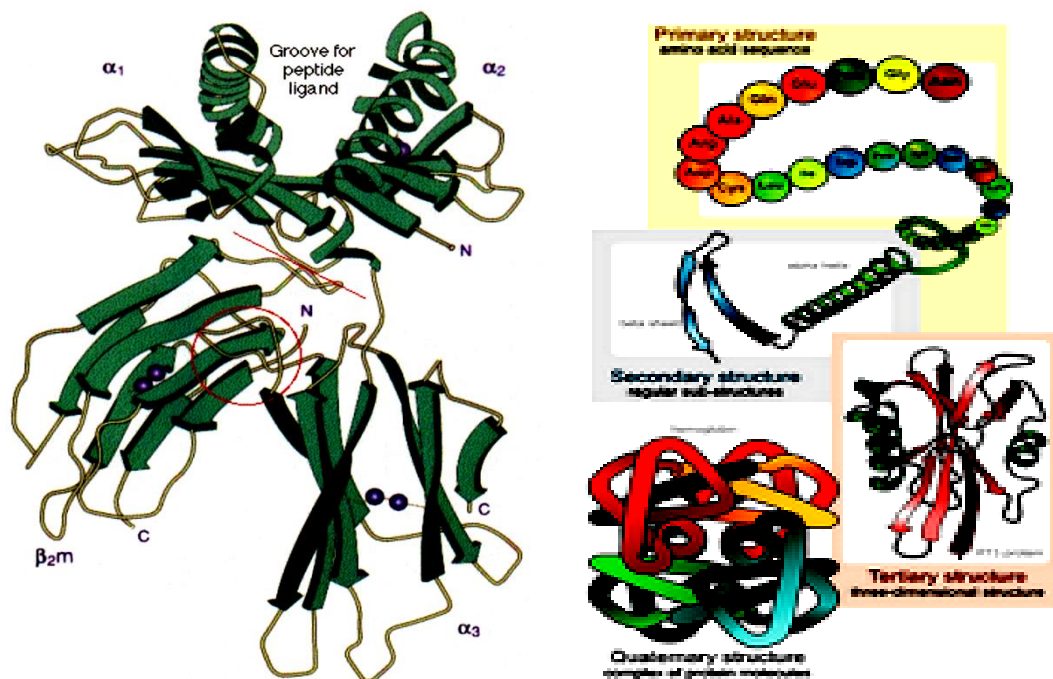

Figure 4.15. Comparison between the structure of primary, secondary and tertiary.

Collagen is a rod -shaped molecule, with a length of approximately 3000 with a diameter of only 15. Helical pattern of the combined three polypeptide chains, is totally different from the one strand helix hydrogen bonds can not be found. However, each strand helix of collagen is stabilized by power repel pyrrolidine ring of proline and hydroxyproline residues. In this helical shape that is more open than the twisted helical tense, pyrrolidone rings farther apart. The third strand to form superhelical beating each other polypeptides.

Distance of each residue in the superhelical axis is 2.9 to nearly three residues in each round. The third strand of the helix is linked to each other through hydrogen bonds. As the hydrogen donor is glycine residue NH group and the CO group residues

on different chains act as a hydrogen acceptor. Hydroxyl group of hydroxyproline residues also play a role in the formation of hydrogen bonds.

With glycine is understandable why put yourself at every position in the range of one thousand three residues that form helical collagen. The interior of the three- strand helix is very solid. It turns out that glycine is the only residue that fits on the inside. Because there are three helical residues in each round, then every third residue in each strand should be of glycine. Amino acid residues adjacent to the glycine located on the outside of the strand and the space is enough for proline and hydroxyproline residues were great.

Proteins are made up of more than one polypeptide chain has an additional level of structural organization. Each polypeptide chain is called sub- units. Describe the quaternary structure of the protein subunit arrangement in space. For example, hemoglobin, consists of two chains and two chains of hemoglobin subunit composition of the tetramer is instrumental in binding antartempat communication O₂, C O 2, and H + are apart. Viruses are very limited utilize genetic information to form a sheath composed of sub - units of the same sub- units repeated in a symmetrical arrangement.

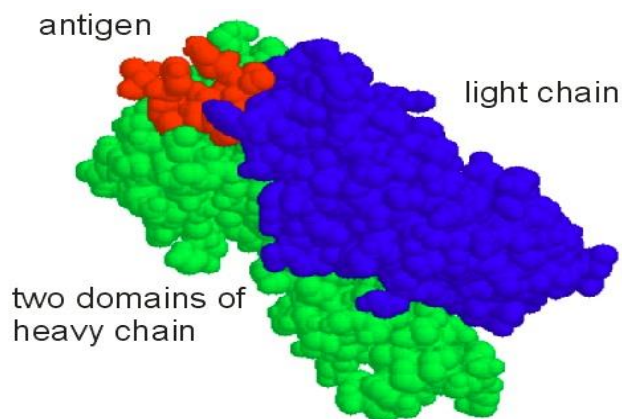

Figure 4.16. Myoglobin space model with the same orientation.

B. Protein Structure Determination Method

1. X-ray crystallography

An understanding of the structure and function of proteins greatly assisted by X-ray crystallography, which is a technique that can declare a three -dimensional positions of atoms in the protein molecule to the right. To develop this method, first the necessary protein crystals that are of interest because this technique requires proper orientation of the entire molecule. Protein crystals can be obtained by adding ammonium sulfate or other salts into concentrated protein solution to reduce solubility. For example, myoglobin will crystallize in a 3 M solution of ammonium sulfate (Figure 2.17).

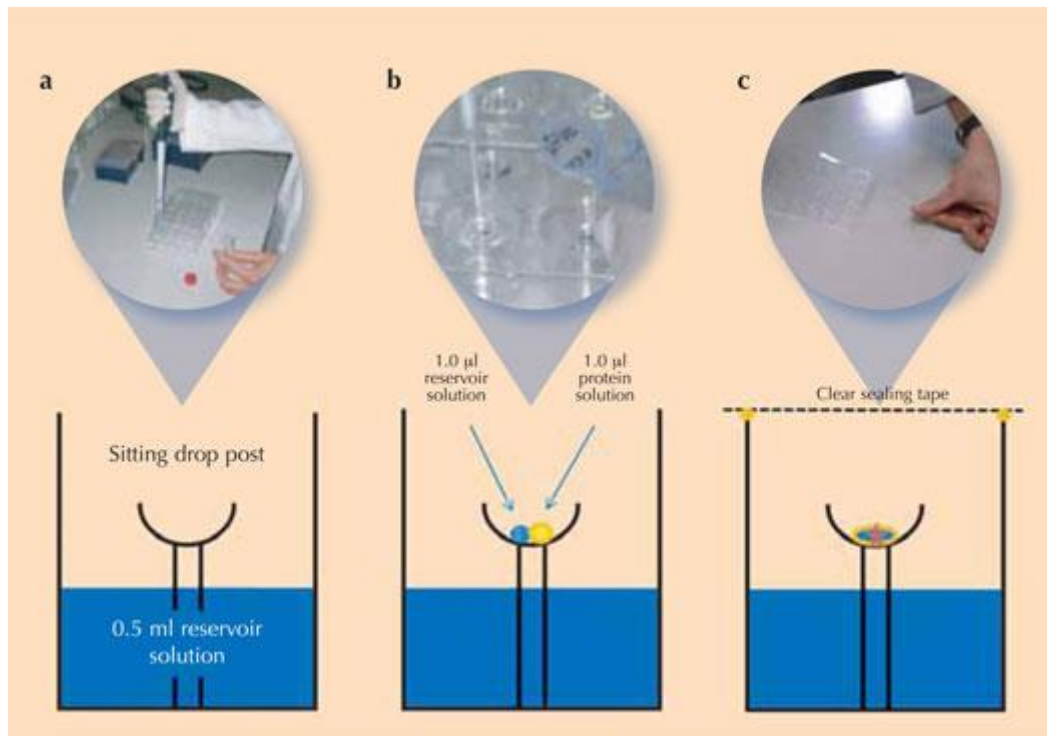

Figure 4.17. Crystallization myoglobin (www.scienceinschool.org).

Slow salting produce irregular crystals, instead of amorphous precipitates. Some proteins crystallize easily, while others require a greater effort. Crystallization is an art, because it requires perseverance, patience and a cool hand. The number of large and complex proteins that have been crystallized on the rise. For example, the polio virus by 8500 - which is the unity of the 240 kd protein subunits surrounding a core of RNA, has been known to be crystallized and its structure by X-ray methods.

The three components that play a role in the analysis of X-ray crystallography is the X-ray source, a protein crystal and detector (Figure 2.18). Beam with a wavelength of 1.54 Å obtained by accelerating electrons to copper. A beam of X-rays directed at a protein crystal. Most of the X-rays will directly penetrate the crystal and the rest will be scattered into various directions. Files are scattered (or experiencing diffraction) can be detected with X-ray film. Blackish color of the film is directly proportional to the intensity of the X-ray detector decentralized or with solid state electronics. The basic principle of X-ray crystallography:

- 1) dipencar X-rays by electrons. The amplitude of the wave is decentralized by atom is directly proportional to the number of electrons. Carbon atoms will scatter X-rays six times more powerful than a hydrogen atom.
- 2) the scattered waves recombine. Each atom in the molecule plays a role in X-ray diffraction of waves. In the film or detector decentralized waves reinforce each other when in the same phase and will cancel out when not in the same phase.
- 3) How has scattered waves recombine depends only on the arrangement of atoms.

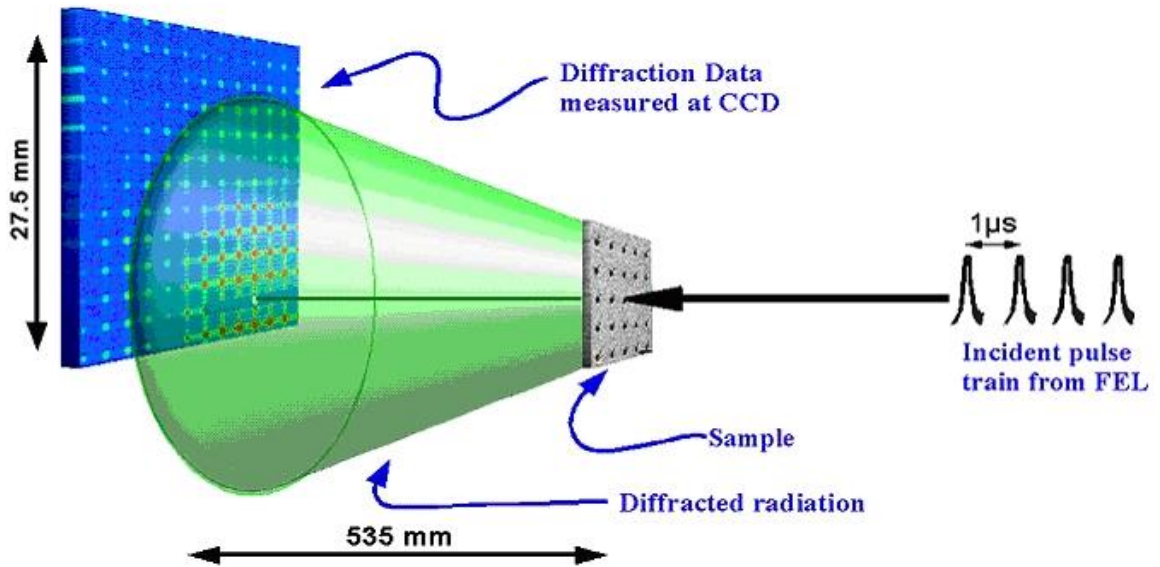

Figure 4.18. Basic experimental X-ray crystallography, crystal and detector (<http://photon-science.desy.de>).

Protein crystals are inserted in the capillary and placed in the right position on the X-ray beam and the film. With careful crystal motion will be generated in the form of X-ray photography composition dots called regular reflection. The intensity of each point on the X-ray photography can be measured and is the basic data for the analysis of X-ray crystallography. The next stage was to reconstruct the picture of the protein based on intensity. In the light microscope or an electron microscope, the scattered beam is focused by the lens that instantly gives an overview. But the lens to focus the X-rays do not exist. Picture can be obtained by using a mathematical calculation called the Fourier transform. Each point depicts the electron density waves, which correspond to the magnitude of the square root of the intensity of the point. Each wave also has phases, namely tops and bottoms of the waves. Phase of each wave determines whether the waves are coming from another point of amplified or deleted. This phase can be determined by the diffraction pattern produced by a standard tagging heavy metals such as uranium or mercury in certain places in the protein.

Now it can be interpreted electron density map, which gives the electron density at points regularly spread in the crystal. Three-dimensional picture of the electron density is shown as a parallel sections and stacked. Each piece is a transparent plastic sheet with the electron density distribution is shown by contour lines, together with the contour lines on a map to illustrate the height of the geological survey. The following stage is the interpretation of electron density maps. Critical factor is the resolution of X-ray analysis were determined by the amount of scattered intensity used in the Fourier synthesis. The recent results of X-ray analysis is determined by the degree of crystalline perfection. For proteins, the resolution limit is usually about 2.

Atomic structure of more than 300 proteins have been revealed. Detailed understanding of the molecular structure has given an overview of how proteins

recognize and bind other molecules, how it functions as an enzyme, how proteins fold and how it goes. This remarkable result will continue to grow rapidly and will give a great influence on the field of biophysics.

2. Spectroscopy NMR (Nuclear Magnetic Resonance)

Nuclear magnetic resonance spectroscopy (NMR) is a widely used and powerful method that takes advantage of the magnetic properties of certain nuclei. The basic principle behind NMR is that some nuclei exist in specific nuclear spin states when exposed to an external magnetic field. NMR observes transitions between these spin states that are specific to the particular nuclei in question, as well as that nuclei's chemical environment. However, this only applies to nuclei whose spin, I , is not equal to 0, so nuclei where $I = 0$ are 'invisible' to NMR spectroscopy. These properties have led to NMR being used to identify molecular structures, monitor reactions, study metabolism in cells, and is used in medicine, biochemistry, physics, industry, and almost every imaginable branch of science.

X-ray crystallography is equipped with NMR spectroscopy, which is able to reveal the atomic structure of a molecule in solution. Nuclei of certain atoms such as hydrogen (^1H) magnetic intrinsically (see Table 4.1). Round protons are positively charged, the same as other charged particles that produce a rotating magnetic moment. Magnetic moment is contained in one of two orientations (called and) when affected by external magnetic field (Figure 4.19). The energy difference between the two orientations is proportional to the magnetic field strength is given.

Table 4.1. The most important point in biological NMR signal.

Core	Total (% weight of elements)
^1H	99,984
^2H	0,016
^{12}C	1,108
^{14}N	99,635
^{15}N	0,365
^{17}O	0,037
^{23}Na	100,0
^{25}Mg	10,05
^{31}P	100,0
^{35}Cl	75,4
^{39}K	93,1

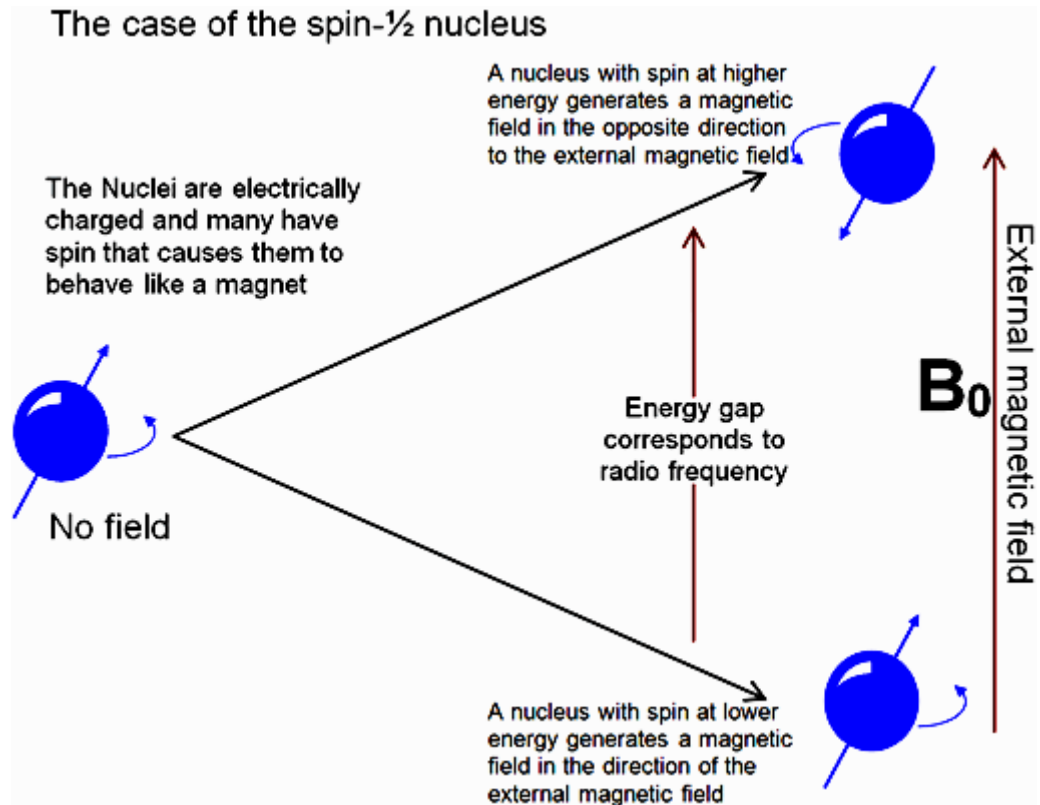

Figure 4. 19. Basic NMR spectroscopy.

Status has a slightly lower energy so slightly more dense (by a factor of 1.00001) because according to the magnetic field. The transition from an isolated low level (α) to β level occurs when the nucleus absorbs electromagnetic radiation with a frequency that is appropriate.

$$\nu_0 = \frac{\gamma H_0}{2\pi}$$

H_0 is the magnetic field strength is fixed and is a constant (called the magnetogyric ratio) for a particular core. For example, in the ^1H resonance frequency of 100 kilogauss magnetic field (10 tesla) is 426 megahertz (MHz), which lies in the area of radio frequency spectrum. The relationship between the energy absorbed by the frequency will show a peak at 426 MHz.

NMR spectroscopy is a technique that is very informative because the local magnetic field is not identical to the magnetic field B_0 is used for all nuclei in the sample. Electron flow around a magnetic core that generates a magnetic field opposite to the local external magnetic field. The degree of defense against B_0 depends on the electron density around. As a result, the core with different environments will absorb energy with slightly different resonance frequencies; This effect is called chemical shift. This shift is expressed as fractional units (ppm, parts per million) relative to standard compounds, such as derivatives of water-soluble tetrametisilen. For example, the proto - CH_3 typically have amounted to 1 ppm, while the aromatic protons have 7

ppm. Most of the proton chemical shifts in protein molecules located between 1 and 9 ppm. NMR spectral absorption peak called lin (lines). Particular proton is usually more than one cause lin nonequivalen influenced by adjacent protons; This effect is called spin - spin coupling. Hydrogen atoms separated by three or less covalent bonds be linked in this way.

Brief on the sample magnetization induced by radio -frequency pulses will disappear with time, the sample will experience relaxation and return to a balanced state. This relaxation process can explain the structure and dynamics of macromolecules because it is very sensitive to the geometry and motion. Another thing that gives a lot of information is NOE (Nuclear Overhauser Effect), an interaction between the core is inversely proportional to the distance between the nucleus rank of six. Magnetization is transferred from the excited to the core nucleus that is not excited when they are separated less than approximately 5 (Figure 4.20). Overhauser spectroscopy spectrum of the two - dimensional core and improved (NOESY = nuclear Overhauser Enhancement Spectroscop) graph showing pairs of adjacent protons. Diagonal line NOESY spectrum corresponding to the spectrum of one - dimensional chemical shift. Peaks outside the diagonal line gives new information: identifies pairs of protons at a distance of less than 5 (Figure 4.20). Overlapping peaks in the NOESY spectrum can usually be separated by using NMR spectra of proteins are characterized by ^{15}N and ^{13}C . Irradiation of these cores will be separated NOE peak along the axis, which is an approach called multidimensional NMR spectroscopy. Three-dimensional structure of proteins can be determined from a number of these relationships.

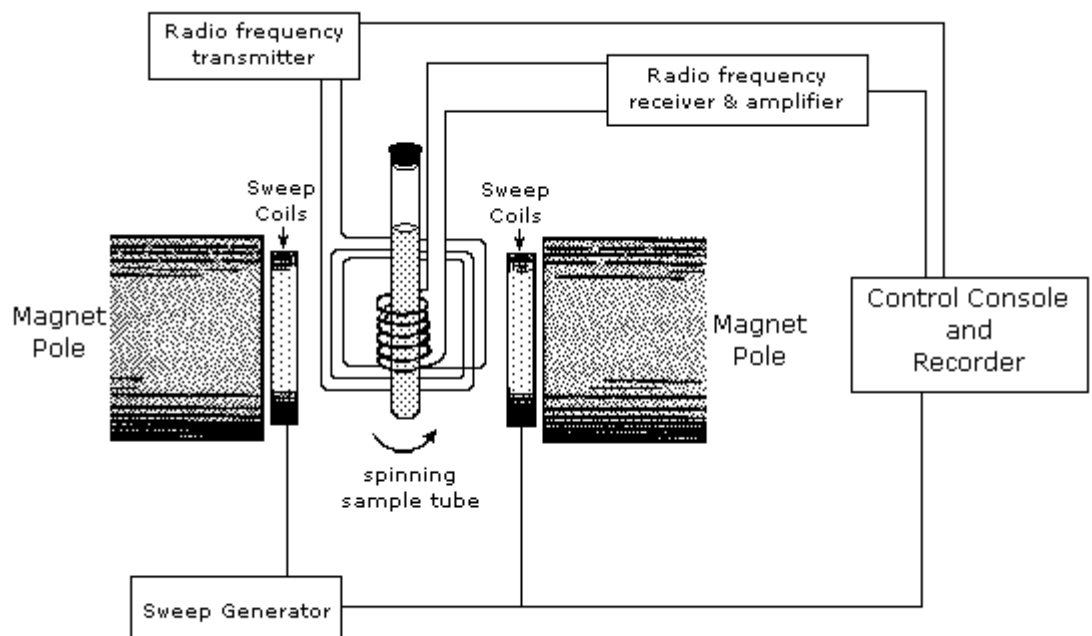

Figure 4.20 Diagram of an NMR spectrometer (cnx.org)

Only the NMR spectroscopic techniques and X-ray crystallography can express three-dimensional atomic structure of proteins and biomolecules detailed else. X-ray method gives a good overview of the resolution, but requires a crystal. NMR method, on the contrary, effective for proteins in solution and requires a very concentrated solution (1 mM - or 15 mg / ml for the 15 - kd protein). Biggest size currently in use for NMR method is 30 kd, for larger proteins do not give accurate results. However, much can be done within the boundaries of these domains because proteins are usually smaller than 30 kd. Additionally NMR spectroscopy rays can also explain the dynamics. NMR techniques and X-rays are complementary in the study of the structure.

EXERCISE

To improve your understanding of the material above, do the exercises below!

- 1) Explain the basic principles kristaligrafi 3 X-ray!
- 2) Describe the structure of the amino acids in the form of amino acids was isolated and dipolar ionic form!
- 3) Briefly describe the difference in the architecture (structure) of proteins and function!
- 4) How to obtain protein crystals in X-ray crystallography techniques?
- 5) Explain briefly the physical principles associated with the NMR technique!

Instructions to Answer Exercise

If you have difficulty in answering the questions above, to help you read the following explanation:

- 1) The basic principle of X-ray crystallography:
 - a) X-rays by electrons dipencar. The amplitude of the wave is decentralized by atom is directly proportional to the number of electrons. Carbon atoms will scatter X-rays six times more powerful than a hydrogen atom.
 - b) the scattered waves recombine. Each atom in the molecule plays a role in X-ray diffraction of waves. In the film or detector decentralized waves reinforce each other when in the same phase and will cancel out when not in the same phase.
 - c) How has scattered waves recombine depends only on the arrangement of atoms.

2)

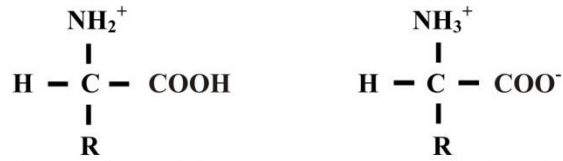

- 3) The primary structure is the sequence of amino acids. Secondary structure associated with the setting position space adjacent amino acid residues in the linear sequence. This steric arrangement gives the periodic structure. Helix - and strand showed secondary structure. Tertiary structure depicting spatial arrangement of amino acid residues far apart in the linear sequence and pattern sulfide bonds.
- 4) protein crystals can be obtained by adding ammonium sulfate or other salts into concentrated protein solution to reduce solubility. For example, myoglobin will crystallize in a solution of ammonium sulfate 3 M.
- 5) using the NMR resonance mechanism of magnetic field caused by the movement of electrical charges in the protein molecules.

RESUME

Protein plays an important role in almost all biological processes. Proteins are essential components or major components of animal or human cells. Therefore it is forming cells of our body, the protein contained in the food serves as a major agent in the formation and growth of the body. Average composition of chemical elements contained in the protein are as follows: Carbon 50% , 7% hydrogen, 23% oxygen, 16% nitrogen, 0.3% sulfur, and phosphorus 0.3% .

Amino acids are the basic structural units of proteins. A - amino acid consists of an amino group, carboxyl group, and the H atoms that are all specific R groups attached to the carbon. The carbon atom is called as adjacent to the carboxyl group (acid).

Proteins fold into secondary, tertiary, and quaternary structures based on intra-molecular bonding between functional groups or intermolecular bonding (quaternary only) and can obtain on a variety of three-dimensional shapes depending on the amino acid sequence. All proteins have primary, secondary and tertiary structures but quaternary structures only arise when a protein is made up of two or more polypeptide chains. The folding of proteins is also driven and reinforced by the formation of many bonds between different parts of the chain. The formation of these bonds depends on the amino acid sequence..

An understanding of the structure and function of proteins greatly assisted by X-ray crystallography, which is a technique that can declare a three -dimensional positions of atoms in the protein molecule to the right. X-ray crystallography is equipped with NMR spectroscopy, which is able to reveal the atomic structure of a

molecule in solution. Round protons are positively charged, the same as other charged particles that produce a rotating magnetic moment. Magnetic moment is contained in one of two orientations (called and) when affected by the magnetic field from the outside.

CHAPTER 5

PROTEIN FUNCTION

Protein plays an important role in almost all biological processes. The role and activity of the protein are as enzymatic catalysis, transport and storage, coordinated motion, mechanical support, immune protection, to awaken and deliver nerve impulses, and the regulation of growth and differentiation. Table 5.1 is a summary of some of the major types of proteins and their functions.

Table 5.1
The Functions of Proteins.

Function	Type	Sample
Catalase	Enzyme	Pepsin catalytic
structural	protein structure	Kalogen (binding tissue and bone), elastin, keratin (hair, skin)
Motile (mechanical)	contractile protein	Actin, myosin (muscle)
Storage (of nutrients)	transport protein	Casein (milk), ovalbumin (egg), ferritin (iron storage)
Transportation (of nutrients)	transport protein	serum albumin (fatty acids), hemoglobin (oxygen)
Regulator (from cell metabolism)	Protein hormone Enzymes regulating	Insulin Fosfofruktokinasa
Protection (immunity blood)	clotting Protein Antibody	Immune globulin Thrombin, Fibrinogen
Response toxic	protein toxin	venom toxin Bacterial toxin (bortulisme, diphtheria)

A. Enzymatic Catalysis

Almost all chemical reactions in biological systems are catalyzed by specific macromolecules called enzymes. Most reactions such as hydration of carbon dioxide are simple, while others such as chromosome replication reaction is very complicated. Enzymes have great catalytic power, generally increases the reaction rate up to a million times. Chemical transformation in vivo is difficult to take place without the presence of the enzyme. Thousands of enzymes known in nature and many of them have been able to be crystallized. The fact remains that almost all known enzymes are proteins. So protein is central in determining the pattern of chemical transformations in biological systems. All reactions in biological systems are catalyzed by proteins called enzymes. Thus it can be realized that the protein plays a role in determining the unique pattern of chemical transformations. Catalytic ability of protein caused by its capacity to bind substrate

molecules with the proper orientation as well as confirming the status of the transition in the formation and dissolution of chemical bonds. Enzymes increase the rate of reaction with selective and efficient manner. There are two things that can be questioned associated with this reaction: first, "to what extent a reaction occurs?" so the discussion area of Thermodynamics, and the second, "how fast the reaction takes place?" so the discussion area of kinetics.

The first question relates to the position of equilibrium (balance): the ratio (ratio) reaction to the results of the reagent (reactance). It is important to recognize the dynamic nature of chemical equilibrium. This system is in equilibrium when the rate of formation of C and D is equal to the rate of the reaction re: the formation of A and B.

$$k_f [A] [B] = k_r [C] [D] \quad \dots(5.1)$$

If taken comparison of the rate constants to the front and back rate, obtained:

$$\frac{k_f}{k_r} = \frac{[C] [D]}{[A] [B]} = k_{\text{equilibrium}} \quad \dots(5.2)$$

This important result emphasizes the dynamic nature of chemical equilibrium, in which occur together reactions that take place to the front and the back. Usually we are interested in the formation of the reagent results



In reviewing the second question, the reaction kinetics, is mismatched to give an overview of the changes in potential energy of the system by using a reaction coordinate diagram shown in Figure 5.1.

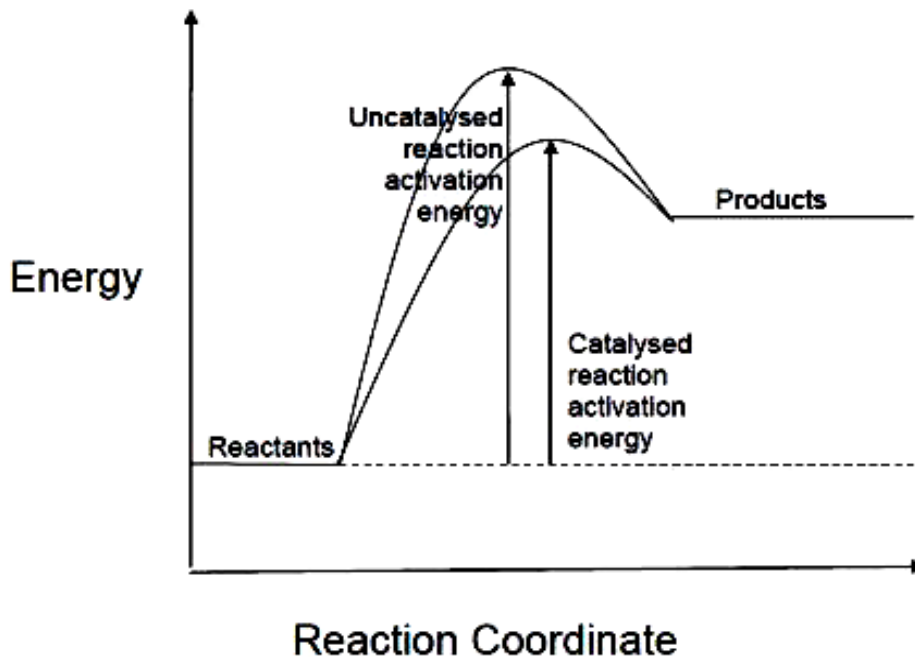
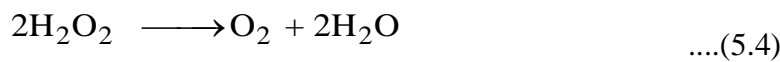

Figure 5.1. Reaction coordinate diagram that shows the catalyst due to the activation energy (mv.picse.net).

In this figure, the results showed a lower potential energy than the reactants, so that the balance is more in favor of the outcome of the reaction. Energy blockage reaction expressed by E_a , the activation energy. This is the energy required to activate the reactants sufficiently to form the activated complex. The presence of a catalyst, the reaction proceeds according to the curve represented by the dotted line in Figure 4.20, ie with lower energy barriers. Then more molecules of reactant contains enough energy to form the activated complex, which increases the reaction rate. Note that E_a degrading influence reactions to the right and to the left just as much. Because it is a catalyst does not affect the equilibrium position (K_{eq}); catalyst only affects the rate-rate to the right and to the left. A reaction is energetically unfavorable but would not give more results by the use of a catalyst, and therefore is not affected by the catalyst E_{reak} like Figure 5.1. Enzymes are biological catalysts. Such as simple catalysts, the enzymes gave a reaction path (mechanism) that other, lower activation energy, and thus more quickly. A good example is katalasa enzymes, which catalyze the reaction



This is an important physiological reaction, because hydrogenperoksida is a toxic result of certain reactions in the metabolism and must be solved quickly. Table 5.2 contains some price E_a for this reaction on various circumstances.

Table 5.2

The activation energy of H_2O_2 decomposition. (Because the rate depends on an exponential function of E_a , the small difference in E_a reflects the large difference in the rate of reaction)

System	E_a (kiloCal mol)
Not catalyzed	18,0
Fe (II) (aq), catalyst	13,0
Pt (p), catalyst	12,0
Katalasa, biocatalyst	5,0

As catalysts, enzymes are the only catalysts compared with inorganic or simple organic. Typical catalytic properties of enzymes including the following.

1. Enzymes increase the rate of reaction in the usual conditions (physiological) of pressure, temperature, and pH. This is a rare condition with other catalysts.
2. Enzymes function with selectivity or specificity of an unusually high rise toward the reactants is done and the type of reaction catalyzed. Then the competing reactions and side reactions not observed in enzyme catalysis.
3. Enzymes provides increased reaction rate compared with the outstanding ordinary catalysts.

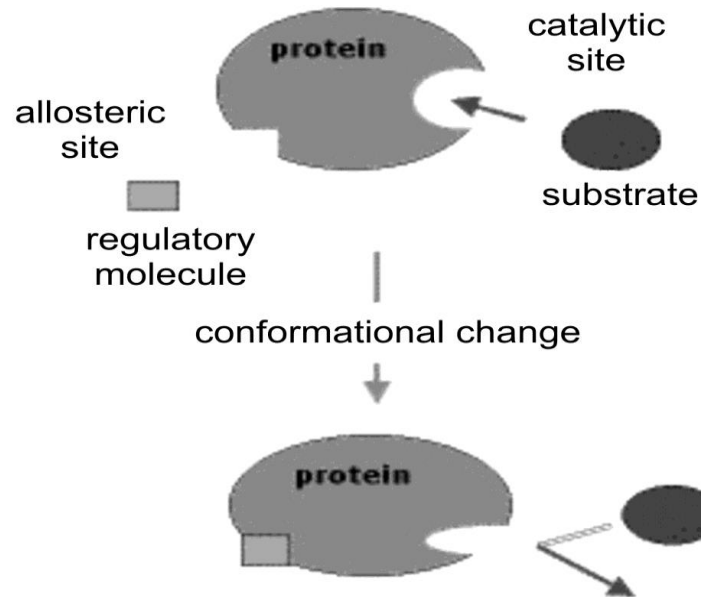
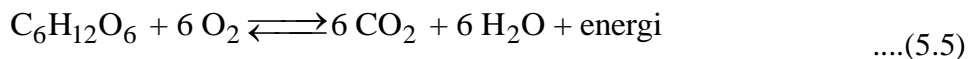

Figure 5.2. The process by which proteins function as enzymes.

B. Transport and Storage

In the discussion of this protein, as has been discussed in Chapter 3, applies also transport and storage processes are supported by the law and the law of Thermodynamics Thermodynamics 1 and 2.

A variety of small molecules and ions are transported by specific proteins. For example, the transport of oxygen by hemoglobin in erythrocytes, and myoglobin a similar protein transports oxygen in the muscles. Iron in the blood plasma is bound to transferrin and stored in the liver in the form of a complex with ferritin, a protein that is different. In a cell heterotrophik, an organic molecule such as glucose, is oxidized to form CO_2 and H_2O



This process releases a vital energy which is then available for cells to carry out useful work. This energy is stored or converted from a form of "deposits" energy into a form of energy "biosynthetic useful" that can be utilized by the cells. Due to cell function isothermal (at constant temperature) then this form of cellular energy is not useful because of work or Work heating can only be obtained of heat energy when the heat transferred from a hot object to a colder object. Due to all cellular processes are essentially chemical, then the energy from the catabolism of food stored in chemical form, as well as chemical energy in the phosphorus-oxygen bond in adenosine triphosphate (ATP).

For a better understanding of the storage and transfer of this energy then let's revisit the thermodynamic and chemical equilibrium. A system can gain or loss of heat to the surroundings as chemical or physical processes. Such changes are discussed in thermodynamics. Energy can be changed in two different ways:

1. Heat flow (Q), is energy transferred due to a temperature difference between the system and its environment.
2. Work (W), ie other useful forms of energy such as mechanical energy.

The first law of thermodynamics for any process reveals that the total energy change in the system is equal to but opposite in sign to the change in total energy from its surroundings. This is the law of conservation of energy which supports the notion that the total energy of the system and its environment (ie the universe) is fixed, regardless of the form of any energy that lasts.

The laws of thermodynamics can be applied to the energy change associated with a chemical process that changes the energy inside (ΔE) is equal to the total energy minus the total energy results where most of the reactants takes place at constant pressure condition (which is open to the atmosphere). It is used for enthalpy change or heat of reaction ΔH marked as follows.

$$\Delta H = \Delta E + (\text{Work pressure-volume}) \quad \dots(5.6)$$

For a reaction at constant pressure, the heat gained or released by the system is equal to H. If the reactants and reaction products is no substance in the standard state (1 atm pressure for gases, the unit for solute concentration and temperature of 25° C) is used to express the sign H° standard enthalpy change. Zero mark written above stated terms standard state thermodynamic scale for each other as well.

Consider the process



$$\Delta H^0 = - 213,000 \text{ kalori/mol}$$

When one mole of methane is burned it releases 213,000 calories. The negative sign means that the system is losing or releasing heat to the surroundings. Conversely, if the energy is positive means absorbed (absorbed) from the surroundings. Calories are units of energy that is defined as the amount of heat needed to raise the temperature of one gram of water from 14.5° C to 15.5° C.

If we review the reverse reaction in the opposite direction:



$$\Delta H^0 = + 213,000 \text{ kalori/mol}$$

The first law of thermodynamics does not allow us to determine whether the reaction in equation (5.1) or equation (5.2) takes place spontaneously. To predict which direction a process will occur spontaneously needed a new scale that is entropy S. Entropy is a measure of disorder in a system. Body Heat, for example, causes the gas molecules that are near us gain kinetic energy thus becomes more irregular. The creation of entropy is a cost to be paid for the actual process occurs by generating a useful effort. Therefore we

can consider the entropy created as a result of the process is actually a Work that lost forever.

Second Law of Thermodynamics states that the process takes place spontaneously, accompanied by the addition of net entropy of the universe. By using the second law can be said whether the process in equation (5.7) or equation (5.8) which takes place spontaneously. For it must be measured entropy change (ΔS) system and surroundings for each process. If the second number of the entropy change is greater than zero, the natural entropy gain and according to the second law is a spontaneous process. To measure S of a system is not difficult, but it is difficult to around S measurements performed experiments. Because of the difficulty in measuring all the result of a process against him, it is much more harmonious spontaneity in terms of defining the amount or number associated with the system. To this number we call the free energy G and give him a sign.

The change in free energy ΔG of a reaction is a measure of the maximum effort that can be obtained from a particular process, and therefore ΔG is a measure of the driving force over a chemical reaction. The change in free energy be defined with an important relationship, is

$$\Delta G = \Delta H - T\Delta S \quad \dots (5.9)$$

where T is the temperature of the reaction. Equation (5.9) gives two factors limit set net driving force for a particular reaction:

1. ΔH : change in energy at fixed pressure
2. $T \Delta S$: extra due to the change in entropy

A spontaneous process is characterized by the loss of free energy; means ΔG is negative. Process in a balanced state does not have a clean driving force for change, so ΔG^0 is zero.

When the reactant substances and basil reaction in the standard state, the free energy change is called ΔG^0 , in accordance with the agreement stated earlier. However, if the biochemical process is mismatched to change our boundaries a little bit about the state standards. Usually the default state for all of the solute is a unit of concentration, ie 1 mole of solute per liter for physically does not react with other substances in the solution. Because the concentration of H_3O^+ in the physiological state requirement is approximately 1×10^{-7} moles per liter, it is appropriate to define a standard physiologic state"with H_3O^+ concentration of 10^{-7} M, with all other solute concentration in the unit, all gas at a pressure of 1 atmosphere and a temperature of $25^\circ C$ as before. in this case we mean the standard free energy change (physiological) is ΔG^0 . related to the free energy of chemical equilibrium, consider the following process.

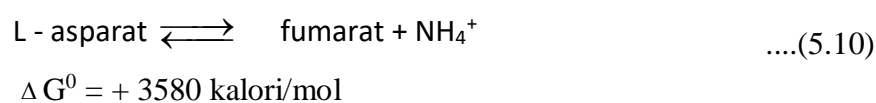

This reaction is not spontaneous if one mole of each of the three reactants and reaction products are mixed together in 1 liter of water at a temperature of $25^\circ C$. Actually,

in this situation fumarate ions will react spontaneously with ammonium ions to produce L-aspartic. Statement equilibrium constant for this reaction is

$$K_{\text{kes}} = \frac{[\text{fumarat}][\text{NH}_4^+]}{[\text{L - asparat}]} \quad \dots(5.11)$$

If the ratio of the concentration of the reaction products of the reactants is less than the price K_{KES} reaction then occurs for a balance. When a chemical change stops, then the system is said to be in a balanced state.

Le Chatelier's Principle states that if a system in equilibrium disturbed, then the system will react or change to search for a new equilibrium position which reduces due to interference. Figure 5.3 illustrates the principle of Le Chatelier.

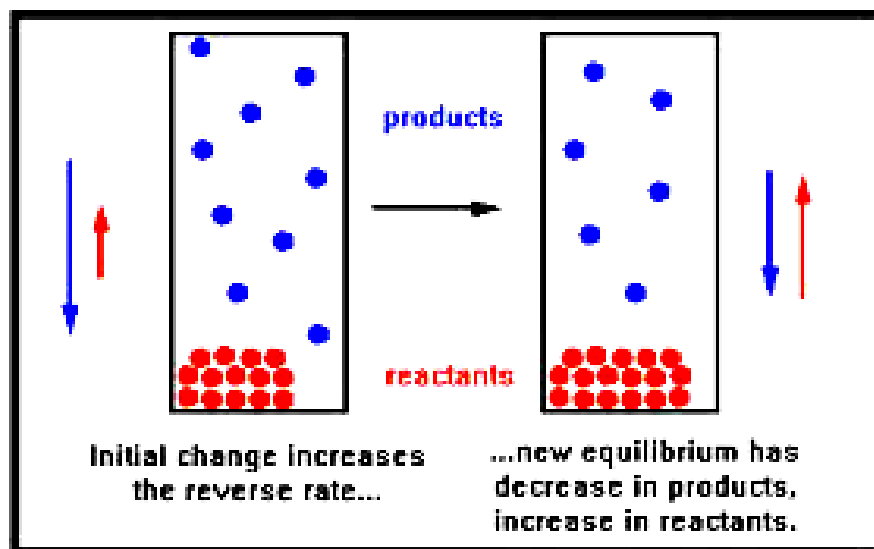

Figure 5.3. Le-Chatelier's Principle (dl.clackamas.edu)

Disturbance shown in the picture is analogous to taking a substance reaction products of chemical systems at equilibrium. For example, if we take the fumarate ion of the system in equation 5.3, probably by reaction with something else, then the reagent is added to react to form the reaction proceeds more substance to the system in balance again. Another thing that is important in thermodynamics and chemical equilibrium is that the free energy changes are additive in chemical reactions that substance pairs reaction is the result of one of the other reactant. A good example is the pair of reaction of the Reactions of the Citric Acid Cycle (<http://2012books.lardbucket.org/>).

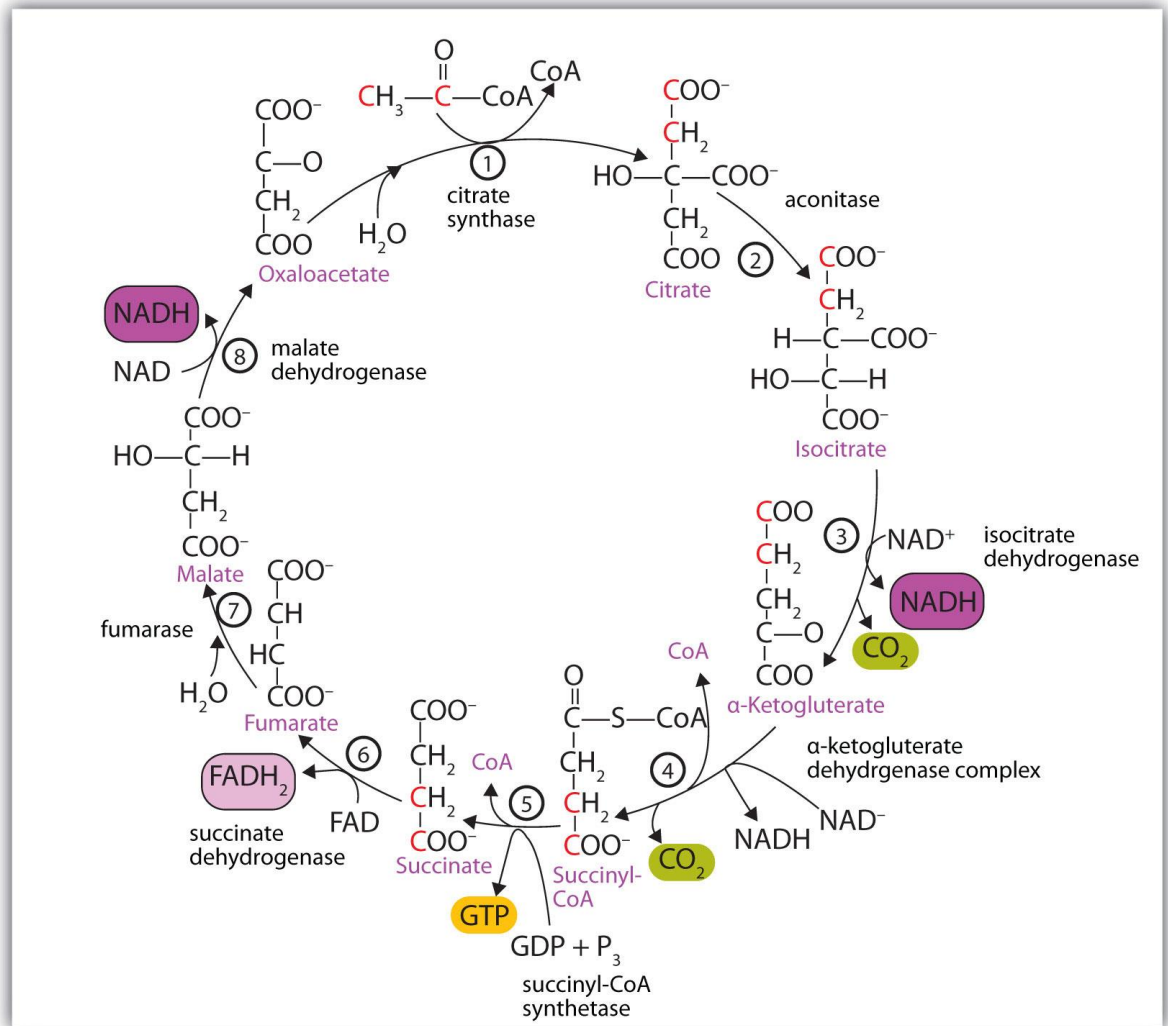

Figure 5.4 Reactions of the Citric Acid Cycle (<http://2012books.lardbucket.org/>).

In the first reaction, acetyl-CoA enters the citric acid cycle, and the acetyl group is transferred onto oxaloacetate, yielding citrate. Note that this step releases coenzyme A. The reaction is catalyzed by *citrate synthase*.

In the next step, *aconitase* catalyzes the isomerization of citrate to isocitrate. In this reaction, a tertiary alcohol, which cannot be oxidized, is converted to a secondary alcohol, which can be oxidized in the next step.

Isocitrate then undergoes a reaction known as oxidative decarboxylation because the alcohol is oxidized and the molecule is shortened by one carbon atom with the release of carbon dioxide (decarboxylation). The reaction is catalyzed by *isocitrate dehydrogenase*, and the product of the reaction is α -ketoglutarate. An important reaction linked to this is the reduction of the coenzyme nicotinamide adenine dinucleotide (NAD^+) to NADH . The NADH is ultimately reoxidized, and the energy released is used in the synthesis of ATP, as we shall see.

The fourth step is another oxidative decarboxylation. This time α -ketoglutarate is converted to succinyl-CoA, and another molecule of NAD^+ is reduced to NADH . The *α -ketoglutarate dehydrogenase complex* catalyzes this reaction. This is the only irreversible

reaction in the citric acid cycle. As such, it prevents the cycle from operating in the reverse direction, in which acetyl-CoA would be synthesized from carbon dioxide.

Comment: So far, in the first four steps, two carbon atoms have entered the cycle as an acetyl group, and two carbon atoms have been released as molecules of carbon dioxide. The remaining reactions of the citric acid cycle use the four carbon atoms of the succinyl group to resynthesize a molecule of oxaloacetate, which is the compound needed to combine with an incoming acetyl group and begin another round of the cycle.

In the fifth reaction, the energy released by the hydrolysis of the high-energy thioester bond of succinyl-CoA is used to form guanosine triphosphate (GTP) from guanosine diphosphate (GDP) and inorganic phosphate in a reaction catalyzed by *succinyl-CoA synthetase*. This step is the only reaction in the citric acid cycle that directly forms a high-energy phosphate compound. GTP can readily transfer its terminal phosphate group to adenosine diphosphate (ADP) to generate ATP in the presence of *nucleoside diphosphokinase*.

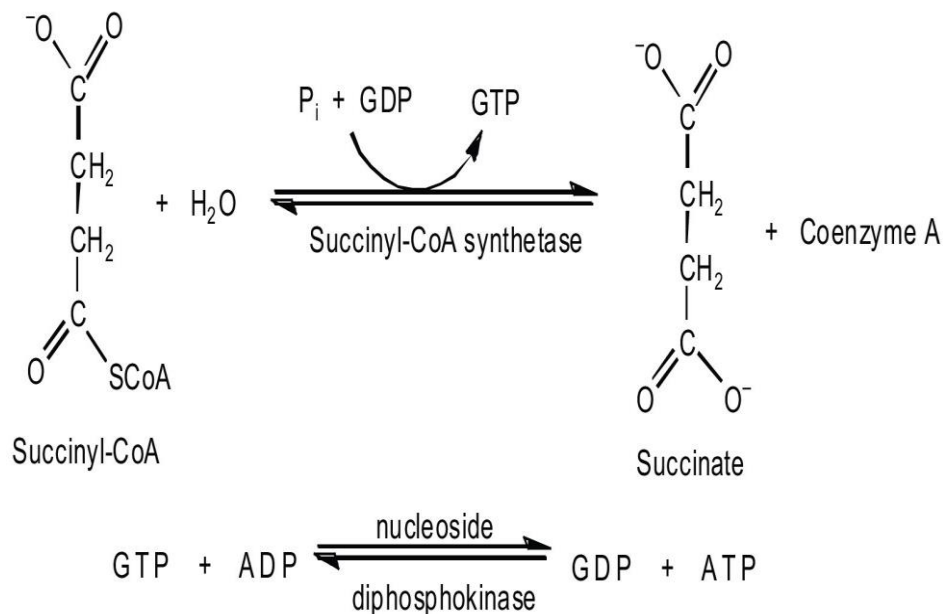

Figure 5.5. reaction in the citric acid cycle that directly forms a high-energy phosphate compound (<http://2012books.lardbucket.org/>)

Succinate dehydrogenase then catalyzes the removal of two hydrogen atoms from succinate, forming fumarate. This oxidation-reduction reaction uses flavin adenine dinucleotide (FAD), rather than NAD⁺, as the oxidizing agent. Succinate dehydrogenase is the only enzyme of the citric acid cycle located within the inner mitochondrial membrane. We will see soon the importance of this.

In the following step, a molecule of water is added to the double bond of fumarate to form L-malate in a reaction catalyzed by *fumarase*.

One revolution of the cycle is completed with the oxidation of L-malate to oxaloacetate, brought about by *malate dehydrogenase*. This is the third oxidation-

reduction reaction that uses NAD^+ as the oxidizing agent. Oxaloacetate can accept an acetyl group from acetyl-CoA, allowing the cycle to begin again.

Cellular energy transfers other than reduction reactions utilizing the energy stored in the bonds of concentrated phosphoric anhydride PO and phosphate ester derivatives. The main biomolecules on power transfer system is Adenosine triphosphate (ATP). ATP serves as the center of "medium of exchange" that connects the biochemical reactions that produce energy in the intermediate processes that require energy in cells. Working of ATP to be centered on the preponderance of high-energy phosphoryl group donor, the phosphoryl group acceptors such as R- -OH type compounds. reaction between ATP hydrolysis and HOH is representative of a donor-acceptor reaction of phosphoryl groups

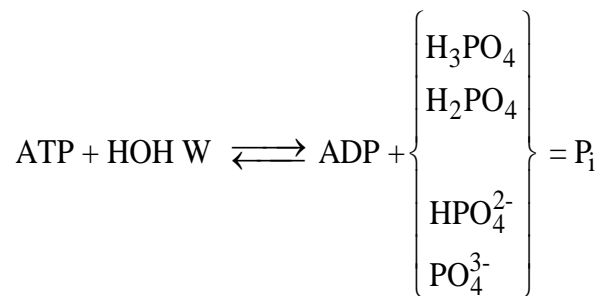

$$\Delta G^0 = -7.3 \text{ kkal/mol}$$

The reaction shown in the above equation produces adenosine diphosphate (ADP) and an equilibrium mixture of these types of substances phosphate ions (at pH7 abundant form shown in color). Rather than detailing the relative amounts of the four types of phosphate better we use P_i emblem to mark the equilibrium mixture of ionic forms of phosphate -free. Free energy change for this reaction is negative in the default state, this indicates a large driving force for this reaction in terms of standard conditions..

Phosphocreatine is converted to creatine and ADP to ATP under the action of creatine phosphatase. This enzyme is present in sufficiently high concentrations to maintain ATP at a high concentration until the muscle is exhausted. Even during heavy work, the concentration of ATP is almost always more than 75% of that at rest. It is only when a working muscle is at the point of exhaustion that ATP levels fall. The generation of ATP and phosphocreatine is shown in Figure 5.4.

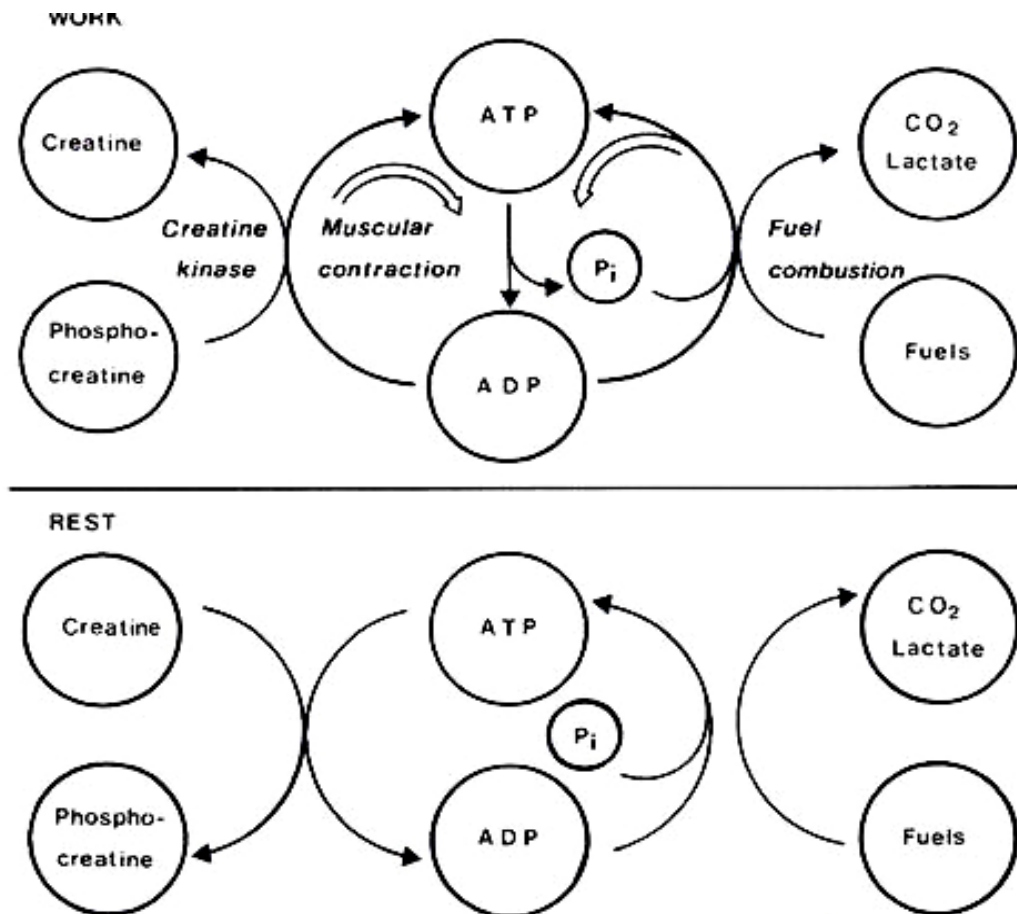

Figure 5.6. Hydrolysis of ATP to ADP provides the energy needed for the muscle to contract. If there is a shortage of ATP from oxidation of substrates, ATP is generated from phosphocreatine. When work ceases ATP generated from oxidation of substrates is used to regenerate phosphocreatine (<http://www.utafoundation.org/P&L/chapter4.htm>).

C. Motion Coordination

Coordinated movement is very important in the life of three systems -driven motility of eukaryotic ATP. In higher eukaryotes, konraksi muscle myosin filaments occurs through the shift and interrupt each other actin. Indeed most eukaryotic cells, ranging from yeast to humans, capable of moving on actin-myosin interaction as this. Cilia and flagella jolt depends on the cooperation of a pair of other proteins-dinein and tubulin.

Microtubules are made of a number of tubulin, forming the mitotic spindle, which is organizing the movement of chromosomes in cell division. Moreover, microtubules act as vesicle and organelle movement pathways in the cell, as shown in the transport along the secretory vesicles of neurons exons. Kinesin is one of several proteins that move vesicles on microtubules. The binding of ATP to myosin, and kinesin dinein generate three protein conformational changes this bike. This structure change is reversed by ATP hydrolysis and

the release of bound ADP and Pi are advancing on the path of the motor proteins actin and tubulin.

Bacteria use a type of motor and other energy sources to move. Bacteria are driven by "the motor rotation flagella" in the cytoplasmic membrane. Motor is powered by a proton-driven style and not by ATP. How ATP-driven conformational cycle or protons in these molecules cause the engine coordinated movements? Applications simultaneously various information obtained from experiments in protein chemistry, structural biology and molecular genetics reveals the secret curtain that surrounds a controlled movement. We begin with the construction of the structural basis of vertebrate striated muscle, a process of producing work that is well known. Vertebrate muscles that react in conscious control, with visible light microscopy stripes. Skeletal muscle consists of multinucleated cells are bounded by a plasma membrane that can be stimulated electrically. A muscle cell contains many myofibrils that run parallel, with a diameter that is located in the cytosol. With electron microscopy, elongated pieces of a myofibril shows that many structural details. Functional units called sarcomeres, repeated every 2.3 (23,000) along the fiber axis. A ribbon A dark and bright bands 1 alternately arranged irregularly. A regional center band called H, is less dense than other parts of the tape. Tape 1 is divided in two by a very narrow Z lines.

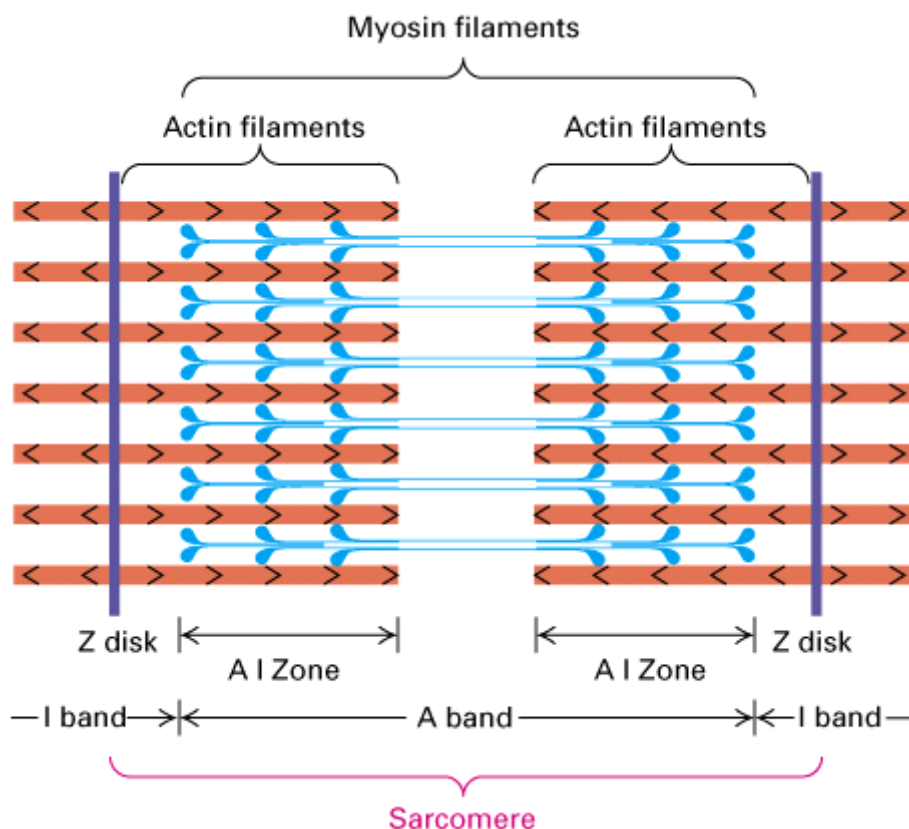

Figure 5.7. Schematic diagram of working striated muscle, showing rows thick and thin filaments overlapping
(<http://www.zoology.ubc.ca/~gardner/musclesstriated.htm>).

The composition of the underlying molecular sarcomere revealed by a cross-section of a miofibril, which showed the presence of two types of protein filaments that interact. Thick filament diameter of 15 nm (150), while the thin filament diameter of approximately 9 nm (90). Thick filaments consist mainly of myosin. Thin filaments containing actin, tropomyosin and troponin complex. Each thin filament is surrounded by three thick filaments, whereas each thick filament is surrounded by six thin filaments. Both types of these filaments interact with cross-bridge which is the domain of the myosin molecule. In muscles that run out of ATP, cross bridges appear in regular interval in the thick filaments and bridging a space of 13 nm between the two types of filament surface. When the contraction, the muscle shortens up like its original length. How this shortening occurs? In the 1950s, Andrew Huxley and Niedergerhe Ralph, and Hugh Huxley and Jean Hanson, separately filed a filament impinge models, which are based on X-ray studies, light microscopy and electron microscopy. The main points of the model are:

1. Thick and thin filament length does not change when the muscle contraction.
2. In contrast, sarcomere length is reduced because of the overlapping part of the two types of filaments increases. Thin and thick filaments shifting when contractions passed.
3. The strength of the contraction caused by an active process with a type of filament moving towards other nearby filament types.

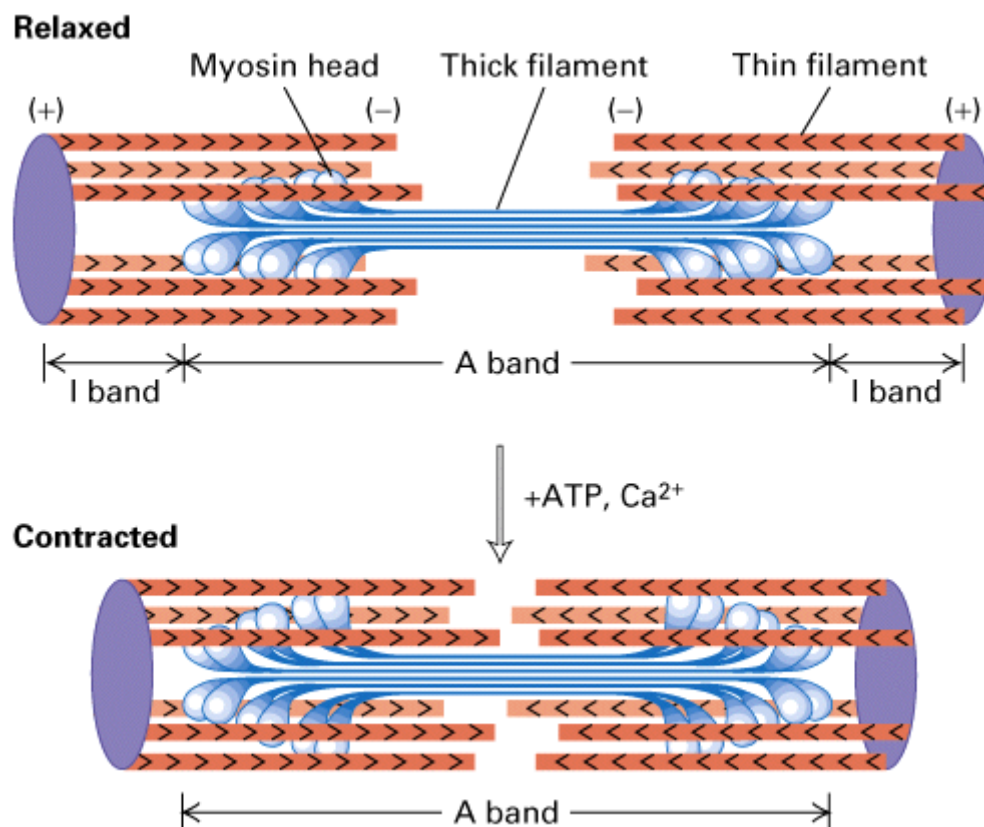
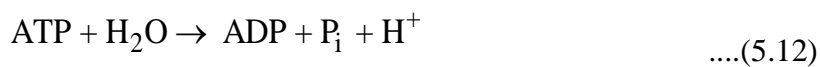

Figure 5.8. The sliding-filament model of contraction in striated muscle.
(<http://www.zoology.ubc.ca/~gardner/muscles%20-%20striated.htm>).

Model filaments impinge evidenced by a tape measure and a 1 and the area of the muscles in the stretched state, rest and contraction. A long filament that remains shows that thick filament length does not change. The distance between the edge of the Z line H in the nearby areas also remain, which indicates that the thin filaments did not change size. Conversely area H and tape measure 1 reduced the contraction, because the area of overlap between thick and thin filaments increases.

Myosin has three important biological activities. First, myosin molecules spontaneously merge into filaments in a solution with pH and physiological ionic strength. It is mainly composed of thick filaments over myosin molecules. Second, myosin is an enzyme. In 1939, Vladimir Engelhardt and Militsa Lyubimova prove that myosin is an *ATPhase*.



The overall reaction, consisting of a series of steps, generating free energy used for muscle contraction. Third, myosin binds actin terpolimerasi form (F-actin), the main element of the thin filament. Indeed, this interaction is essential for generating the force that drives the thick and thin filaments to move pass each other. Myosin can be viewed as a mekanoenzim because these compounds catalyze change in chemical bond energy into mechanical energy.

When actin and myosin are mixed in a solution, to form a complex called aktomiosin. This complex formation is accompanied by an increase in viscosity. In 1940, Albert Szent-Gy rgyi suggests that this increase is reversed by the addition of ATP. He found that ATP dissociate into actin and myosin aktomiosin. He also made a thread aktomiosin the molecule is directed by the flow. It is striking obtained when the yarn is dipped into a liquid containing ATP, K + and Mg +. Yarn aktomiosin shortened, while the threads are made of myosin course not. These experiments unequivocally demonstrated that the energy for muscle contraction comes from cooperation myosin, actin, and ATP.

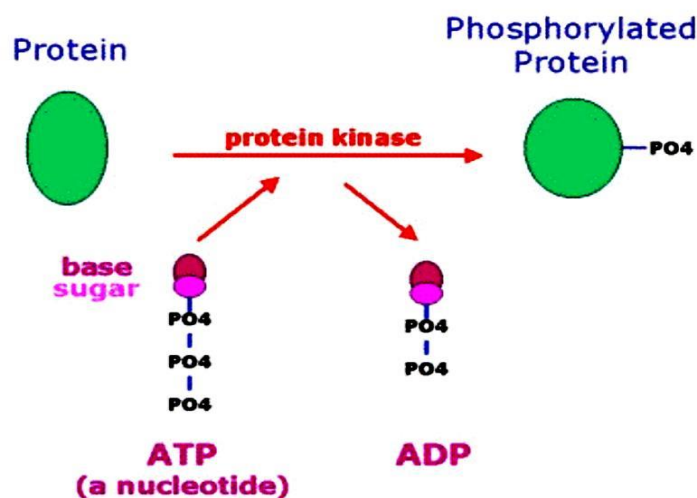

Figure 5.9. The process changes the protein into energy supporting the motion.

D. Mechanical Support

Skin and bone tension caused by the presence of collagen which is a fibrous protein. Thermodynamic study shows that the natural state of a protein in the physiological state of only 5 to 10 kcal / mol more stable than the folded shape. Is this relatively small difference is the nature of protein? Or proteins have been selected to have a low stability properties of all? Studies on site -specific mutagenesis has shown that proteins can be made more resistant to thermal denaturation by entering into the bonds of the molecule. A disulfide in the right location can increase the melting temperature (T_m) of a phage T4 lysozyme protein like 4° C or more. Truly a mutant that contains three additional sulfide which has T_m 23° C higher than the native enzyme types. The protein has a cavity in the core hidrofobnya can be stabilized by replacing a small residue with a large nonpolar residues (such as valine replaces leucine). In contrast, the protein can be made unstable by removing bonds disulfidanya, inserting huge Substituents which are not easily accommodated in the hydrophobic core, or replace the polar residues that make hydrogen bonds or salt good bond.

It has been revealed in many studies on the thermal stability of collagen. Remember that collagen is the main protein of connective tissue that forms a three -stranded helix that is very different from the α helix. Three-stranded collagen helix is stabilized by hydrogen bonds between the strands and locking steric effects of proline and hydroxyproline residues, which is to maintain approximately 60°. Collagen in different species have different melting temperatures (Table 5.4). The pattern is informative: on ice fish collagen has the lowest T_m , whereas warm-blooded mammals collagen the highest T_m . T_m increases with increasing content of proline and hydroxyproline. In general, the melting temperature of the collagen was only slightly above body temperature source.

Table 5.4.

Dependence of thermal stability on the content of proline and hydroxyproline

Sources	Proline plus hydroxyproline (per 1,000 residues)	Thermal Stability		Body Temperature (°C)
		Ts	Tm	
Calfskin	232	65	39	37
Shark Skin	191	53	29	24-28
Cod fish skin / pope	155	40	16	10-14

Note: T_s is the temperature shrinkage of collagen fibers, and T_m is the melting temperature of the collagen molecule that has been isolated

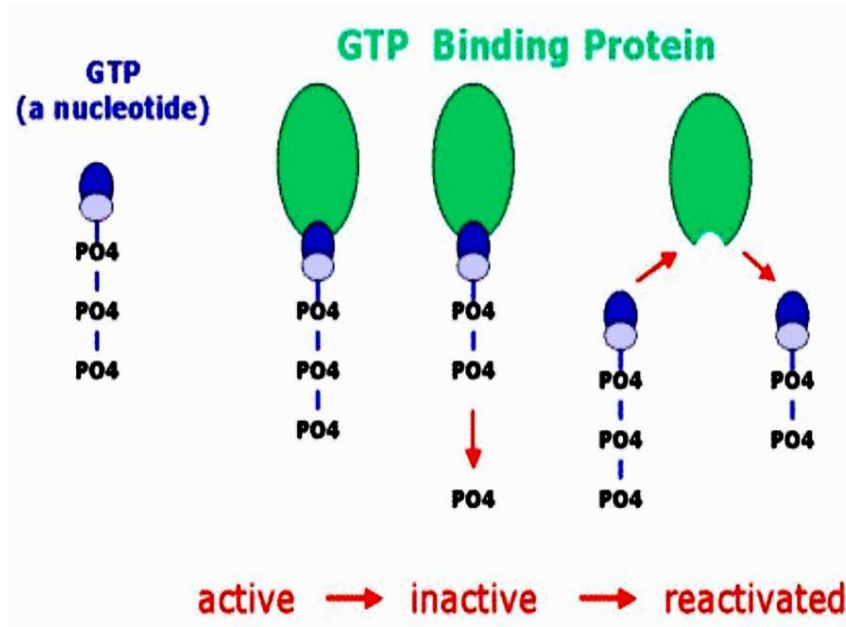

Figure 5:10. The process of activation of protein into energy.

E. Immune Protection

Antibodies are proteins that are highly specific and can recognize and combine with foreign bodies such as viruses, bacteria and cells derived from other organisms. Protein plays an important role to distinguish "I" and "not me".

The immune system of vertebrates is a network that involves many molecules and cells with one purpose: to distinguish between the elements of his own and foreign elements. Its main function is to protect vertebrates against microorganisms such as viruses, bacteria and parasites. The system is continuously checking innumerable molecular units to determine which one is a foreign object and began to destroy it. Immune system to learn from experience and to remember the things he encountered. His trademark is the specificity and the ability to record. The immune system uses two different strategies, but the two are related. Elements of the introduction of the humoral immune response are proteins called soluble antibodies (inonuglobin) and produced by plasma cells. At the cellular immune response, the T-lymphocytes to kill cells that indicate the presence of foreign motifs on its surface. Cellular immunity also trigger a humoral immune response by helping B cells, a plasma cell precursors. Both functions; kill and help begins with the binding of the T-cell receptor peptides presented by MHC proteins on the surface of target cells.

Antibodies (immunoglobulins) are proteins that are synthesized by animals in response to foreign substances. Ioni antibodies secreted by plasma cells are cells derived from B- lymphocytes (B cells). This soluble protein is an introduction to the elements of the humoral immune response (humor is the Latin word for liquid). Each antibody has a specific affinity to the foreign material that triggers the synthesis of antibodies. A foreign macromolecule that is able to trigger the formation of antibodies is called an antigen (or

immunogen). Proteins, nucleic acids polysakarida and generally an effective antigen. The affinity of an antibody is not specific to the entire surface of the macromolecular antigen but to a specific site on a macromolecule called "antigenic determinants" (or epitopes). Most small molecules that can not trigger the formation of antibodies. Nevertheless they can trigger the formation of specific antibodies when attached to macromolecules. Macromolecular carrier molecule is a chemical group that is attached, and is called a "determinant haptenik". Molecule itself is called a hapten. Antibody formation generated by the bound hapten will bind free hapten as good.

Animals can actually make specific antibodies against virtually any foreign chemical groups. Dinitrofenal group (DNP) is very specific in triggering the formation of antibodies and therefore has been used extensively as a determinant haptenik. Specific antibodies against DNP (term: anti-DNP antibodies) can be obtained in the following manner:

1. DNP group is covalently bonded to the carrier protein such as bovine serum albumin (BSA / bovine serum albumin) fluoronitrobenzen by reacting with nucleophilic side chains of lysine or another.
2. DNP-BSA, as an immunogen (antigen) is injected into a rabbit. Levels of anti-DNP antibodies in the serum of rabbits began to increase a few days later (Figure 5: 8). This initial antibody molecules are a class of immunoglobulin M (IgM) and has a mass close to 1000 kd.

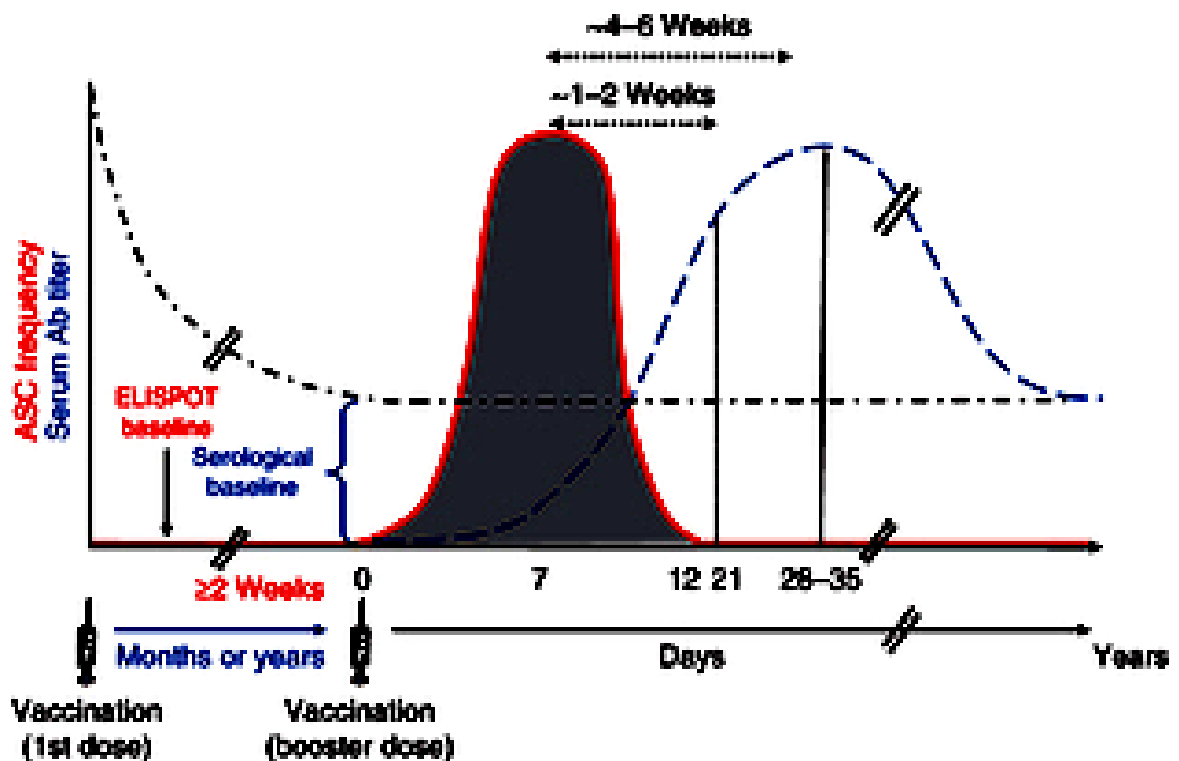

Figure 5:11. Kinetic appearance of immunoglobulin M and G in serum after immunization.

3. Approximately 10 days after injection immunogen, the amount of immunoglobulin M decreases, and with it an increase in the number of anti-DNP antibodies of other classes called immunoglobulin G (IgG), which has a mass of 150 kd.
4. Levels of anti-DNP antibodies immunoglobulin class G landed approximately 3 weeks after injection of immunogen. One booster dose of DNP-BSA when given at that time will result in increased levels of anti-DNP antibodies in the serum of rabbits further.
5. Blood was drawn from rabbits that had been immunized. Serum obtained is called antiserum obtained after immunization because it can contain as much as 1 mg / ml anti-DNP antibodies. Almost everything is a class IgG, the major immunoglobulin in serum.
6. The next step is to separate the anti-DNP antibodies from other antibodies as well as from other serum proteins. Things to distinguish anti-DNP antibodies are very high affinity to DNP. Thus these antibodies can be separated by affinity chromatography column containing wear dinitrofenil group is covalently attached to the matrix of insoluble carbohydrates.

F. Generate and Deliver Nervous Impulse

The response of nerve cells to stimuli is mediated by specific receptor proteins. For example, rhodopsin a light-sensitive protein found in retinal rod cells. Receptor proteins that can be triggered by specific small molecules such as acetylcholine, plays a role in the transmission of nerve impulses at synapses connect nerve cells. From the study of nerves known that nerve bundle composed of long strands called axons or nerve fibers. Each axon is a part of a single neuron. Along the nerve fibers and the marked information is transmitted in the form of electrical pulses all- or-none or on-off called action potentials or potential spikes (spike potential). This term the emergence of the impulses on the oscilloscope screen.

In teleological, nervous system problems is similar to the transmission of messages over the phone long distance. Both the low -frequency grooves and high -frequency grooves are arranged in parallel, each one must be modulated with separate signals that much. The review of anatomic and physiology suggests that animals have a low frequency electric grooves parallel the amount of variety. The more complex the number of animals it tends to flow more and more. Throughout each of these grooves (nerve fibers), the information is transmitted to the electric pulses. Every single strands of energy and its relationship with the preparation called a neuron. Differences properties involves the generation and transmission of electric potential in biology. The oldest experiment called biolistrik occurs at the end of the eighteenth century. Galvani put two kinds of metal into the frog's leg muscles and observe kekejangannya. He connects with the electrical responses correctly, but assuming that the electricity generated by a vital process in the muscle. Volta proved that electricity Galvani not derived from biological phenomena; absence of real biological power plant has not been found until nearly a century longer. Now it is known that all nerve fibers and also possibly of all cell membranes, electrically charged. The load cell membrane is a potential cause of this spike is so small that it can not be observed with instruments

Galvani and Volta. Biolistrik helps a lot in the field of application of physical instrumentation; thus attracting the attention of many people who have a background in physics who are interested in biological problems so that they can apply the skills he already has. A major application is biolistrik impulses by nerve conduction study.

G. Arrangements Growth and Differentiation

Setting the order of expression of genetic information is essential for uniform growth and cell differentiation. Only a small portion of the genome within the cell to be expressed at a time. In bacteria, the repressor protein is a regulatory element that is essential to dampen a specific segment of DNA within a cell. In higher organisms, growth and differentiation is regulated by protein growth factors. For example, nerve growth factor controlling the growth of nerve tissue. Activity of different cells in multicellular organisms is coordinated by hormones. Many hormones such as insulin and TSH (Thyroid -stimulating-hormone) is a protein. Protein in cells plays a role in regulating the flow of energy and elements.

EXERCISE

To improve your understanding of the material above, do the exercises below!

- 1) Explain briefly how proteins can function as enzymes to catalyze reactions that occur in biological systems!
- 2) Give an explanation of entropy as referred to in the Second Law of Thermodynamics!
- 3) Give two examples of protein function in the coordination of movement!
- 4) Explain briefly how proteins play a role in immune protection to the organism!
- 5) Explain briefly how proteins play a role in generating nerve impulses and deliver!

Instructions to Answer Exercise

If you have difficulty in answering the questions above, consider the answers below as a reference.

- 1) All the reactions in biological systems are catalyzed by proteins called enzymes. Thus it can be realized that the protein plays a role in determining the unique pattern of chemical transformations. Catalytic ability of protein caused by its capacity to bind substrate molecules with the proper orientation as well as confirming the status of the transition in the formation and dissolution of chemical bonds.
- 2) Entropy is a measure of disorder in a system. Body Heat, for example, causes the gas molecules that are near us gain kinetic energy thus becomes more irregular.

The creation of entropy is a cost to be paid for a process that was happening with the Work generating useful. Therefore we can consider the entropy created as a result of the process is actually a Work that lost forever.

- 3) In higher eukaryotes, the muscle contractions occur through myosin and actin filaments shifts that interrupt each other. Indeed most eukaryotic cells, ranging from yeast to humans, capable of moving on actin-myosin interaction as this. Cilia and flagella jolt depends on the cooperation of a pair of other proteins-dinein and tubulin.
- 4) Antibodies are proteins that are highly specific and can recognize and combine with foreign bodies such as viruses, bacteria and cells derived from other organisms. Protein plays an important role to distinguish "I" and "not me". The immune system of vertebrates, for example, is a network that involves many molecules and cells with one purpose: to distinguish between the elements of his own and foreign elements. Its main function is to protect against makroorganisme vertebrates such as viruses, bacteria and parasites.
- 5) The response of nerve cells to stimuli is mediated by specific receptor proteins. For example, rhodopsin a light-sensitive protein found in retinal rod cells. Receptor proteins that can be triggered by specific small molecules such as acetylcholine, plays a role in the transmission of nerve impulses at synapses connect nerve cells.

RESUME

Protein plays an important role in almost all biological processes. The role and activity of the protein are as catalytic enzymatic, transport and storage, coordinated motion, mechanical support, immune protection, arouse and deliver nerve impulses, and the regulation of growth and differentiation.

All reactions in biological systems are catalyzed by proteins called enzymes. Thus it can be realized that the protein plays a role in determining the unique pattern of chemical transformations. Catalytic ability of protein caused by its capacity to bind substrate molecules with the proper orientation as well as confirming the status of the transition in the formation and dissolution of chemical bonds. Typical catalytic properties of enzymes including the following.

1. Enzymes increase the rate of reaction in the usual conditions (physiological) of pressure, temperature, and pH.
2. Enzymes function with selectivity or specificity of an unusually high rise toward reactants actuated and the type of reaction catalyzed.
3. Enzymes provide a tremendous increase in the reaction rate compared with the usual catalyst.

A variety of small molecules and ions transported by specific proteins. For example, the transport of oxygen by hemoglobin in erythrocytes, and myoglobin a similar protein transports oxygen in the muscles. Iron in the blood plasma is bound to transferrin and stored in the liver in the form of a complex with ferritin, a protein that is different.

Coordinated movements are very important in the life of three systems -driven motility of eukaryotic ATP. In higher eukaryotes, the muscle contractions occur through myosin and actin filaments shifts that interrupt each other. Indeed most eukaryotic cells, ranging from yeast to humans, capable of moving on actin-myosin interaction as this.

The protein has a function as a mechanical support, tension of skin and bone, for example, is caused by the presence of collagen which is a fibrous protein. Thermodynamic study shows that the natural state of a protein in the physiological state of only 5 to 10 kcal / mol more stable than the folded shape.

The protein also has a function as an immune protection Antibodies are proteins that are highly specific and can recognize and combine with foreign bodies such as viruses, bacteria and cells derived from other organisms. In addition, protein also serves to generate and deliver nerve impulses. The response of nerve cells to stimuli is mediated by specific receptor proteins. For example, rhodopsin a light-sensitive protein found in retinal rod cells. Receptor proteins that can be triggered by specific small molecules such as acetylcholine, plays a role in the transmission of nerve impulses at synapses connect nerve cells.

CHAPTER 6

STRUCTURE AND FUNCTION OF DNA

The discovery that deoxyribonucleic acid (DNA) is the prime genetic molecule, carrying all the hereditary information within chromosomes, immediately focused attention on its structure. It was hoped that knowledge of the structure would reveal how DNA carries the genetic messages that are replicated when chromosomes divide to produce two identical copies of themselves. Some DNA sequences even permit the double helix to twist in the left-handed sense, as opposed to the right-handed sense originally formulated for DNA's general structure. And while some DNA molecules are linear, others are circular. Still additional complexity comes from the supercoiling (further twisting) of the double helix, often around cores of DNA-binding proteins.

DNA is a very long thread a macromolecule composed of a large number of deoxyribonucleotides, each of which is composed of a base, a sugar and a phosphate group. If a body can be compared, then the DNA is described as the brain that can manage every process in the body. In addition, DNA also has an important role in heredity. DNA is a chemical compound that is essential to living things. The main task of carrying genetic material from one generation to the next. DNA is also a polynucleotide compounds that carry hereditary traits typical of the chromosome.

DNA is important in terms of heredity. Package all the genetic information and passes it on to the next generation. The basis for this lies in the fact that DNA is made of genes and gene makes chromosomes. Humans have 23 pairs of chromosomes-a total of 46 chromosomes. Twenty-two of these pairs, called autosomes, look the same in men and women. To 23 and the pair are called sex chromosomes differ between men and women. Females have two copies of chromosome X or XX, while males have one X and one Y. Both parents have reproductive cells-sperm and ova in the father's or the mother's egg. Sperm and egg contains half the number of chromosomes-23 each. When the egg and sperm fertilize, this gives rise to a cell that has a complete set. So one half of the genes inherited from each parent.

The term chromosome popularized by Waldeyer (1888), the original saying: chroma, which means color and soma, which means body. Thus, the chromosome is a delicate objects shaped like a straight or curved rod and consists of substances which easily binds the dye in the nucleus.

Chromosome function of individual traits and carries genetic information because there is a gene in the chromosome. Chromosome shape is different, depending on the species, but the form of chromosomes are fixed for each species $m \Phi \mu = 0.2$ to 20μ , μ Size: $p = 0.2$ to 50 Arm amounted to one or two; equal length or unequal length; shape symmetrical or asymmetrical.

Chromosome parts consist of:

1. Kromomer is bead -shaped structure which is the accumulation of chromatin material,
2. The centromere is the area of the indentation (kontriksi) around the middle of chromosomal regions, which also found the kinetochore,

3. the kinetochore is the region where the threads of the spindle attachment and the attachment of the chromosome arm,
4. The telomere is a region of chromosome function terujung stability so that the ends of chromosomes DNA does not decompose.

Satellite is part of the sphere -shaped chromosome and chromatid is located at the end of the arm.

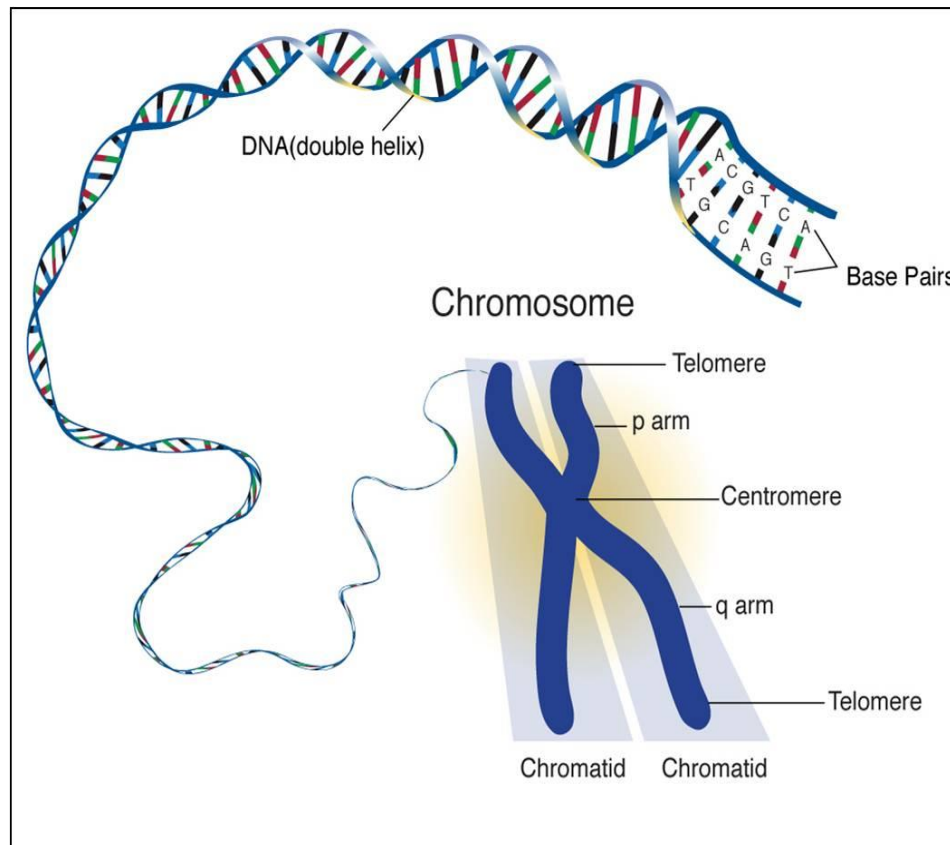

Figure 6.1. Chromosome

Based on the location of the centromere and arm, forms a chromosome can be divided into four kinds:

1. The form telocentric, ie if the location of the centromere is located at the tip,
2. Form acrocentric, namely the location of the centromere near the end,
3. Form of submetacentric, ie if the location of the centromere rather away from the ends of chromosomes and usually forming the letter L or J
4. form of metacentric, ie if the location of the centromere is in the middle so that the length of each arm together

Another term that is closely related to the discussion of the DNA are genes. According to Morgan, the gene is a particle that is compact and occupies a locus on chromosome containing the genetic information unit and set the properties of certain decline. The function of genes is to: (1) regulate the growth / development and metabolism of the individual, and

(2) convey genetic information from one generation to the next. Meanwhile, place the gene in the homologous chromosomes (chromosomes are in pairs) is called locus. Chemically gene constructed by DNA.

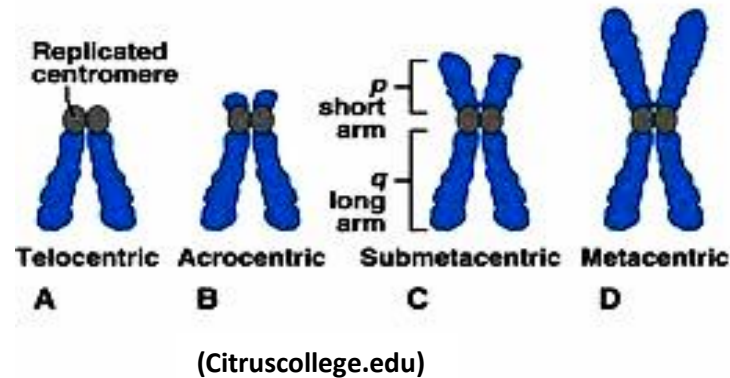

Figure 6.2. Chromosomal forms based on the location of the centromere

DNA was first discovered by F. Miescher (1869) of sperm cells and avian erythrocyte cells, subsequently renamed as nuclein. Another discovery made by Fischer (1880), which is about the substance of pyrimidine (Cytosine and Thymine in the form) and two purines (adenine and guanine). After the discovery, the invention is also equipped with Levine (1910) on the 5 -carbon sugar ribose, deoxyribose sugar, and phosphoric acid in the core. The existence of the majority of DNA in the nucleus (the cell nucleus). But there is also contained in the mitochondria.

In 1953, Frances Crick and James Watson discovered the DNA molecule as a model of a double-stranded helical structure, or better known as the double helix of Watson-Crick. DNA a polynucleotide macromolecules composed of nucleotide polymers repetitive, structured duplicate, form DNA haliks double and twisting to the right. Each nucleotide consists of three groups of molecules, namely: (1) 5 -carbon sugar (2-deoxyribose), (2) group consisting of nitrogen bases are adenine purines (Adenine = A) and guanine (guanini = G), as well as the class of pyrimidine, namely cytosine (cytosine = C) and thymine (T = thymine), and (3) a phosphate group.

Bases on the DNA molecule carries the genetic information, whereas the sugar and phosphate groups have a structural role. Deoxyribose sugar in a deoxyribonucleotides. Deoxy prefix indicates that the sugar shortage of one atom of oxygen that exist on the ribose, the parent compound. Nitrogenous bases are purine and pyrimidine derivatives. Purines in DNA are adenine (A) and guanine (G), and thymine pirimidinnya is (T) and cytosine (C). A nucleoside consists of a purine or pyrimidine base and which binds to sugar. Fourth nukletida units in DNA called deoxyadenosine, deoksiganosin, deoxythymidine, and deoksitidin. In a deoksiribonukleosida, N-9 in the purine or pyrimidine N-1 to C-1 bound to the deoxyribose. Configuring the N-glycoside bond is a bond (alkaline located above the plane of the sugar). A nucleotide is a phosphate ester of a phosphate ester of a nucleoside. The most common place in the esterification of nucleotides that are naturally present in nature is the C-5 hydroxyl groups on the sugar. Such compounds are called nucleoside 5-

phosphate or 5-nucleotide. For example, deoxyadenosine 5'-triphosphate (dATP) is a precursor that is activated on DNA synthesis; nucleotide that is used when there are two ties in the unit trifosfatnya fosfoanhidrida. Numbers with an asterisk indicates atoms in sugar, while the number without sign indicates that a deoxyribose sugar to distinguish these compounds from ribose sugar in the form of ATP.

DNA backbone, which is fixed along the molecule, composed of deoxyribose binding to phosphate groups. Especially 3'-hydroxyl on the sugar a deoxyribonucleotides 5'-hydroxyl is connected to the adjacent sugars through phosphodiester bridges. Portions vary in DNA is a sequence of four kinds of bases (A, G, C and T). The units are called nucleotides dioksidenilat, deoksiganilat, deoksisitidilat, and deoksitimidilat.

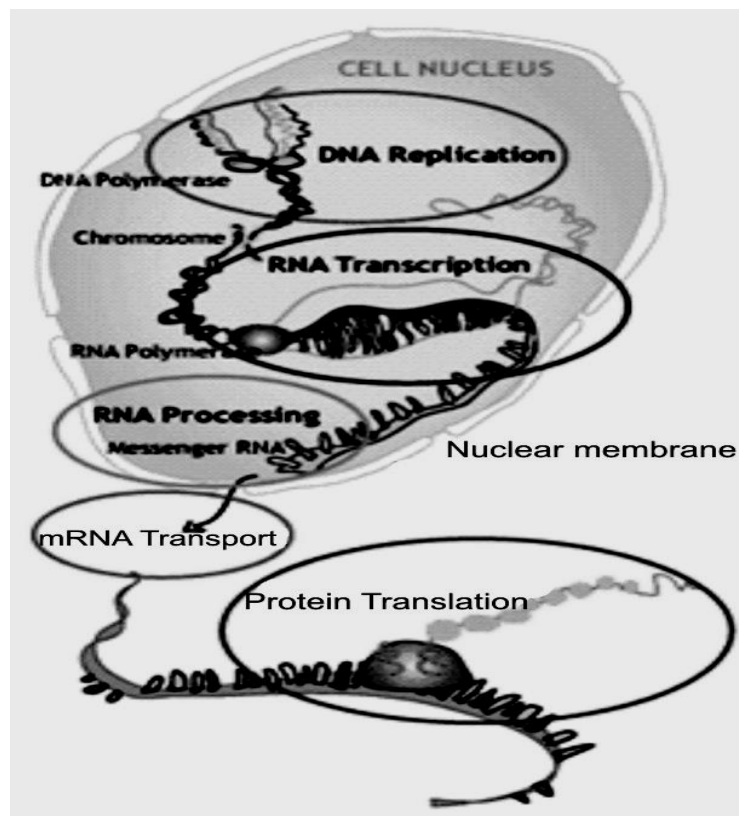

Figure 6.3a. Mechanism of action of DNA.

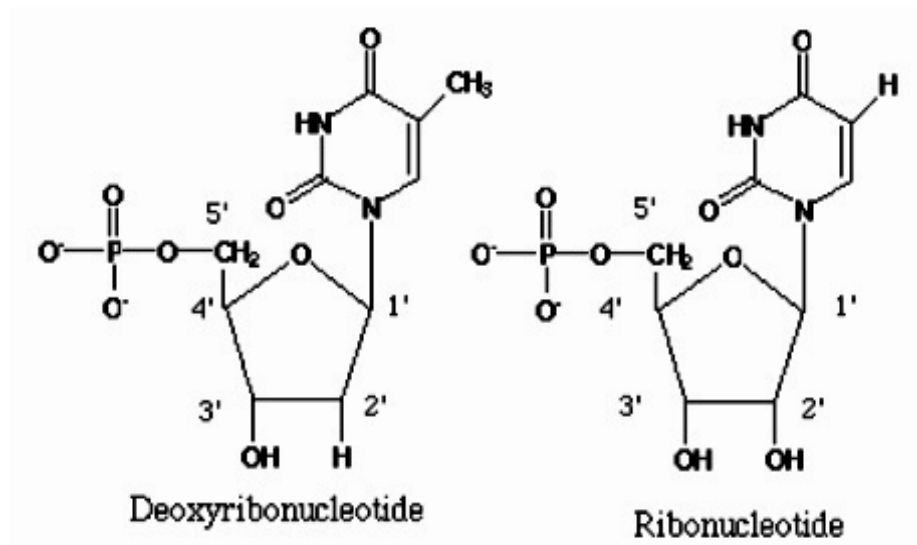

Figure 6.3b. The difference between deoxyribonucleotide and ribonucleotide.

A. Structure of DNA Double Helix

Friedrich Miescher for the first time to separate the DNA from the cell nucleus in 1896 and named the newly discovered substance "nuclein", the beginning of the term nucleic acid. Although DNA is extensively studied over the following years, however biologiknya role as a carrier of genetic information remain unclear until during the late 1940s when Avery and his colleagues showed that the purified DNA can move the efficacy offspring of a bacterial strain to which other. In 1953, research by X-ray crystallographic by James Watson and Francis Crick revealed the three-dimensional structure of DNA and its replication concluded soon. This amazing achievement is one of the most significant in the history of biology because it paves the way for an understanding of the function of genes at a molecular level. Watson & Crick overview analyzing X-ray diffraction of DNA fibers made by Rosalind Franklin and Maurice Wilkins and establish a structural model that basically proved correct. Important characteristics of their DNA models are:

1. Two helical polynucleotide chains coiled around one axis. Both chains have opposite direction (Figure 6.4).

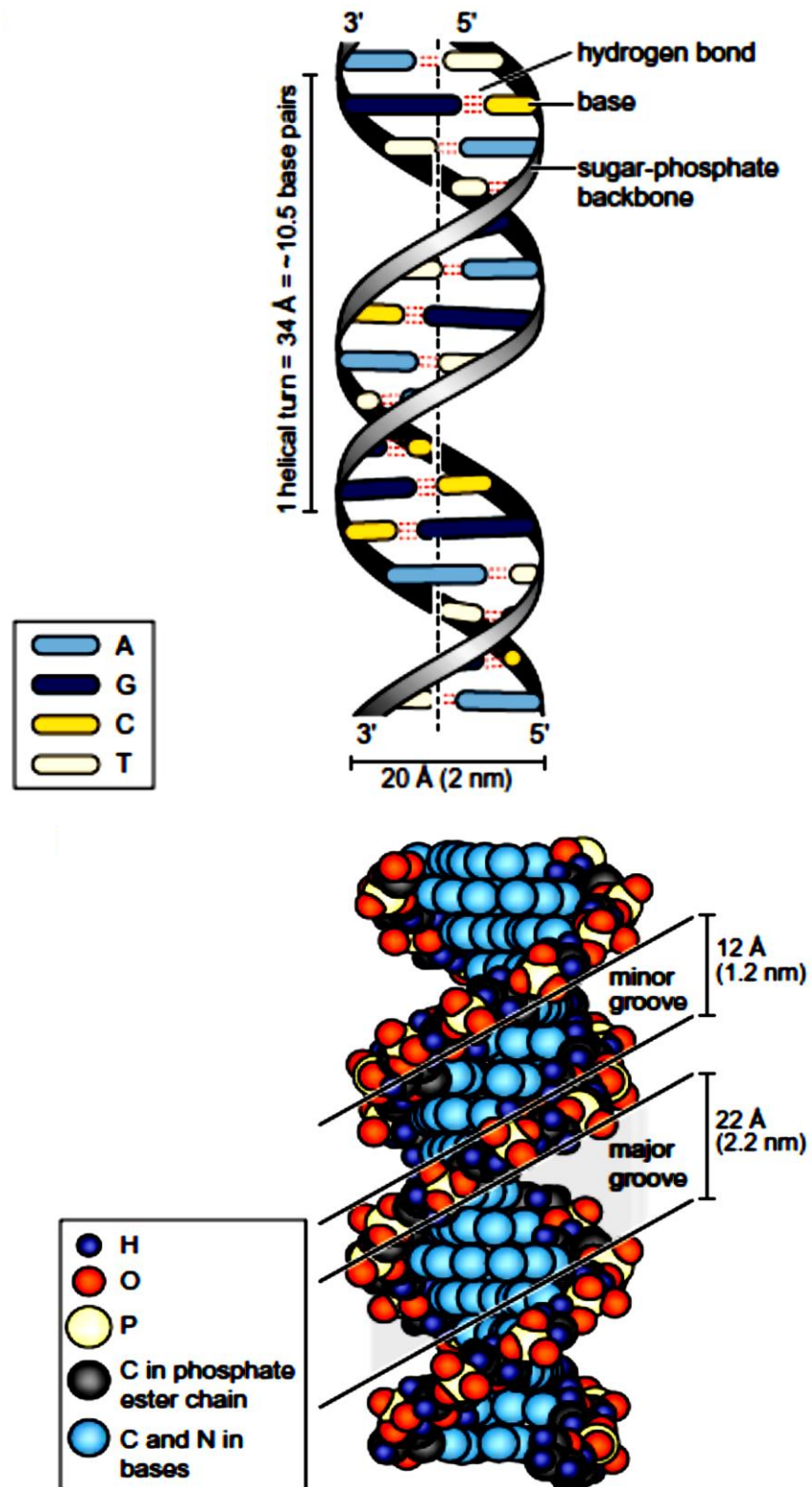

Figure 6.4. Overall configuration of the DNA double helix. Note that the two strands are complementary and anti-parallel. Hydrogen bonds between the two bases (http://biology.kenyon.edu/courses/biol63/watson_06.pdf)

2. Purine and pyrimidine bases are on the inside of the helix, whereas the units of phosphate and deoxyribose are on the outside. Alkaline fields perpendicular to the helical axis. Sugar fields nearly perpendicular to the plane of the base.
3. The diameter of the helix is 20 Å. The distance between adjacent bases is 3.4 Å in the helical axis with a rotation angle of 36° . thus, repeated after 10 rounds helical residues on each chain, ie at intervals of 3.4 Å.
4. Both chains are interconnected through hydrogen bonds between the base pairs. Adenine always pairs with thymine; guanine always pairs with cytosine.
5. Sequence of bases along the polynucleotide chain is not restricted in any way. Exact sequence of bases that contain genetic information.

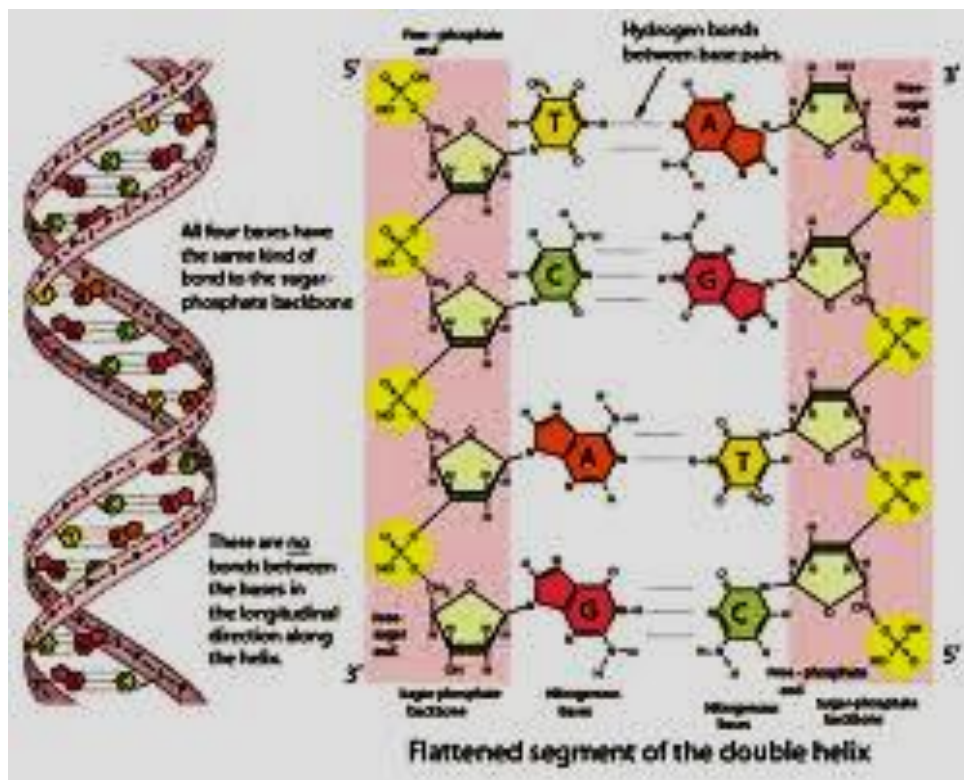

Figure 6.5a

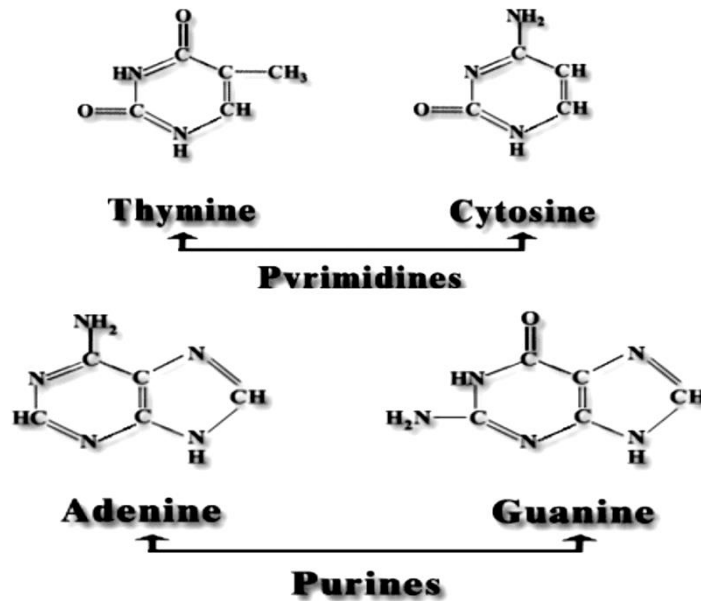

Figure 6.5.b

Figure 6.5 Hydrogen bonds between the two bases.

The most important aspect of the DNA double helix is the specific base pairs. Watson and Crick should conclude that adenine pairs with thymine, and guanine with cytosine, due to steric factors of hydrogen bonds. This steric restriction caused by the helical nature of the sugar phosphate backbone is regular at each polynucleotide chain. The glycosidic bond between the sugar and base pairs is approximately 10.8 Å. Purine-pyrimidine base pairs corresponding right in the room. Instead there is not enough room there for two purines. There is more than enough room for two pyrimidines, but both will be too far apart to provide hydrogen bonding. Because it is a member of the base pairs in a DNA helix must always be a purine and the other a pyrimidine, due to steric factors. Base pairs is further limited by the requirement of hydrogen bonding. Hydrogen atoms in the purine and pyrimidine bases have been given positions. Adenine pairs with cytosine can not because there will be two hydrogens near one binding site and no hydrogen in other places. Similarly unpaired guanine with thymine. Instead adenine forms two hydrogen bonds with thymine, while guanine forms three hydrogen bonds with cytosine. The attraction between the two most powerful base pairs in the orientation and distance of the hydrogen bond.

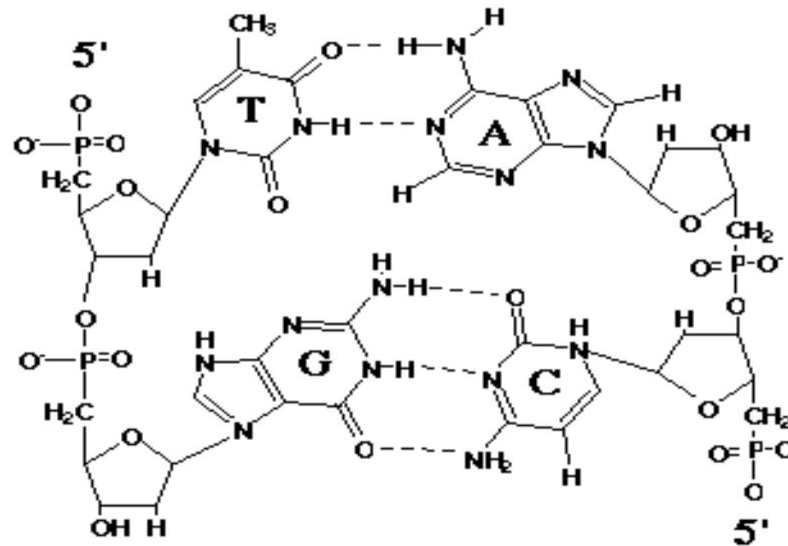

Figure 6.6. Model of the DNA double helix molecule that shows three base pairs. Note that the second strand opposite direction. B form of DNA, the double helix of Watson-Crick classic, pictured here. In this form, the bases field perpendicular to the helical axis.

Scheme of base pairs is strongly supported by the results of previous studies on DNA base composition in various species. In 1950, Erwin Chargaff discovered that the ratio of adenine to thymine and guanine to cytosine approaching 1.0 in all species observed. The meaning of this discovery became apparent at the time of Watson-Crick proposed. New at times it can be seen that the above findings reflect the essential terms of the structure and function of DNA base pairs species. The structure of the DNA double helix are shown in Figure 6.3 is a B form DNA (B-DNA). The double helix model of DNA replication immediately suggested method. Watson & Crick hypothesized month after they present a structural model of DNA in a simple and easily understandable treatise as follows.

When the actual arrangement of bases on one chain is known, can be written with proper arrangement of bases in the chain is the partner for a specific pair formation. Thus, the chain is a chain complements the other, and this picture shows how the deoxyribonucleic acid molecule can perform duplication.

- Discussion of the previous discussion is usually put forward the concept of self duplication mold. Both prints are considered one of the copy itself directly or mold that produces a mold " negative " which will be printed to produce a ' positive ' original anymore. Absolutely not explained in detail how it would happen in terms of atoms and molecules.

Now we learn a model for deoxyribonucleic acid, which in essence, is a pair of mold, which is mutually complementary. We imagine that prior to duplication the hydrogen bonds is lost, and both chain and split open. Then each chain acts as a template for the formation of a new chain partner for himself and eventually on to two pairs chain, which previously there was only one pair of chains. In addition, the sequences of base pairs that should be copied exactly.

B. DNA and Protein Interactions

We now turn to the molecular mechanisms of DNA replication. In 1958, Arthur Kornberg and his colleagues isolate the enzyme from *E. Coli* which catalyzes the synthesis of DNA. They named the enzyme DNA polymerase; are now called DNA polymerase I as it was later discovered that another DNA polymerase. DNA replication occurs on a complex interplay and coordinated more than 20 kinds of proteins. We now focus attention on the DNA polymerase I to explain some of the new principle. DNA polymerase is a single polypeptide chain 110-kd, which catalyzes additions deoxyribonucleotides units step by step into a DNA chain.

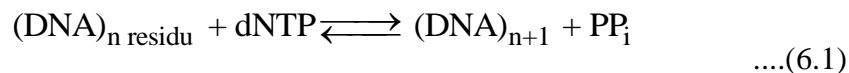

(Abbreviation show deoxyribonucleotides triphosphate dNTP and PP_i pyrophosphate group show). DNA polymerase I requires the following components to synthesize a DNA chain:

1. There should be a precursor that has been activated four-5'-triphosphate deoksiribonukleosida dATP, dGTP, dTTP and dCTP. Mg²⁺ ions are also required.
2. DNA polymerase I deoksiribonukleosida added to the 3'-hydroxyl end of the DNA chain that already exists. In other words, we need a beginner chain with a 3'-OH group is free.
3. A DNA template is essential. Prints can be either single- or double -stranded DNA. DNA double strand is effective only when the mold sugar phosphate backbone terminated at one or two places (Figure 3. 4).

Chain extension reaction catalyzed by the DNA polymerase is a nucleophilic attack at the end of the 3'-OH strand beginner (primary) to the innermost phosphorus atom of the triphosphate deoksiribonukleosida. A phosphodiester bridge is formed and pyrophosphate is released simultaneously. Further hydrolysis of inorganic pyrophosphate by pirofosfatase, an enzyme which is widespread, encourage the implementation of polymerase. DNA chain extension takes place toward the 5 → 3' (Figure 6.7).

DNA polymerase catalyzes the formation of phosphodiester bond only when the incoming nucleotide bases in a base complementary to the template strand. The possibility to form a covalent bond is very low unless the base type entry form Watson-Crick base pair with the bases on the template strand.

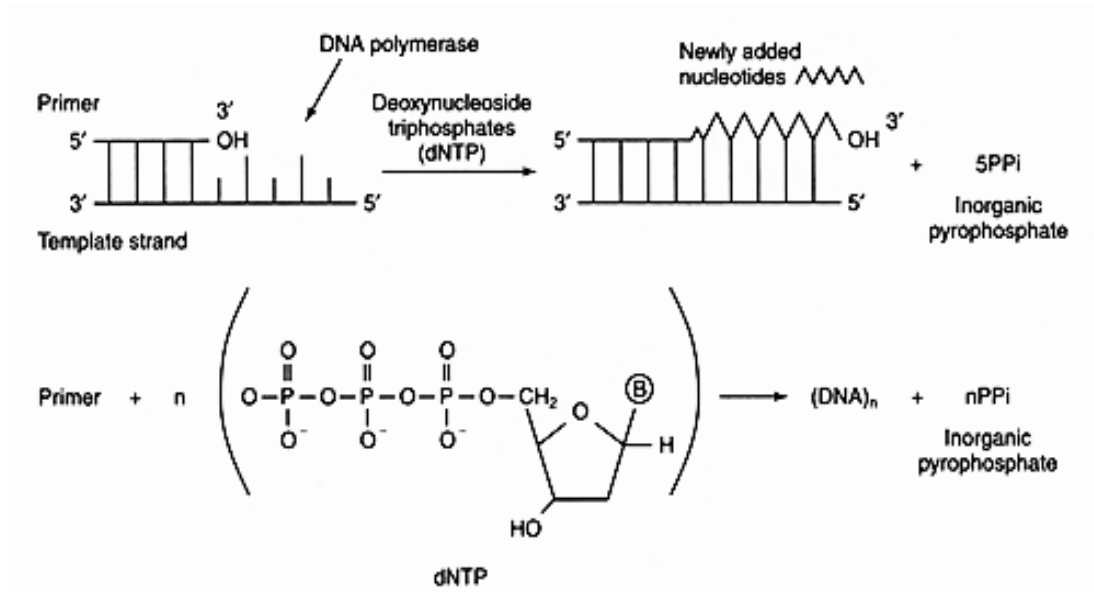

Figure 6.7. Chain elongation reaction catalyzed by DNA polymerase (www.cliffsnotes.com).

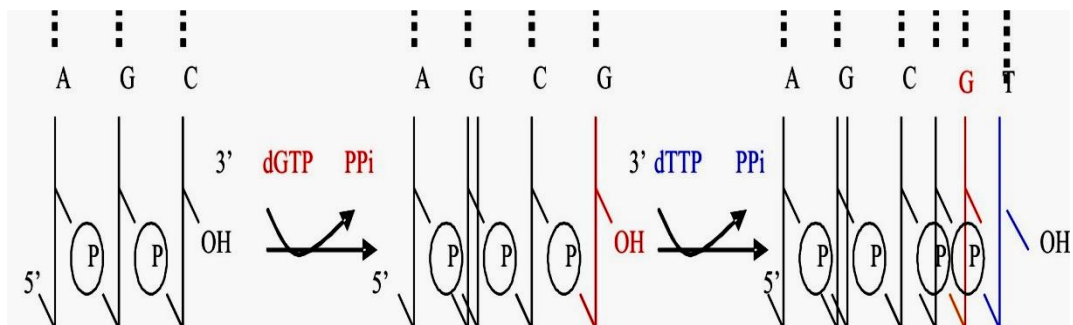

Figure 6.8. DNA polymerases catalyze chain elongation of DNA 5' + 3'

So DNA polymerase is an enzyme that is directed by the mold (template -directed enzyme). The enzyme gets instructions from the mold and synthesizes a product with a base sequence complementary to the sequence of bases in the mold. Indeed, DNA polymerase I is an enzyme that is directed by the first mold was found. Other striking properties of DNA polymerase I enzyme is that it fixes mistakes in DNA by removing incorrect nucleotides. The properties of the DNA polymerase I contributed to the very high accuracy of DNA replication, ratanya average error of less than 10^{-8} per base pair.

C. DNA STRUCTURE DETERMINATION METHOD

Method of determining the structure of DNA can be performed using X-ray crystallography as well as at the time of determining the structure of proteins in Module 2. In 1984, Kary Mullis discovered a great method to reproduce the sequence-specific DNA

sequences. This method is called polymerase chain reaction (PCR, polymerase chain reaction). Suppose a DNA duplex containing the area ABCDE. Millions of copies of C (target) is easily obtained by PCR, if the order of B and D (flanking sequences) are known. Let us mark one strand of the duplex with ABCDE and its complement strand with a'-b'-c'-d'-e'. PCR carried out by adding the following components to the solution containing the target sequence: (1) a pair of starters, b and d', (2) four deoksiribonukleosida triphosphate (dNTP), and (3) a heat-resistant DNA polymerase. One PCR cycle consists of three phases (Figure 6.9).

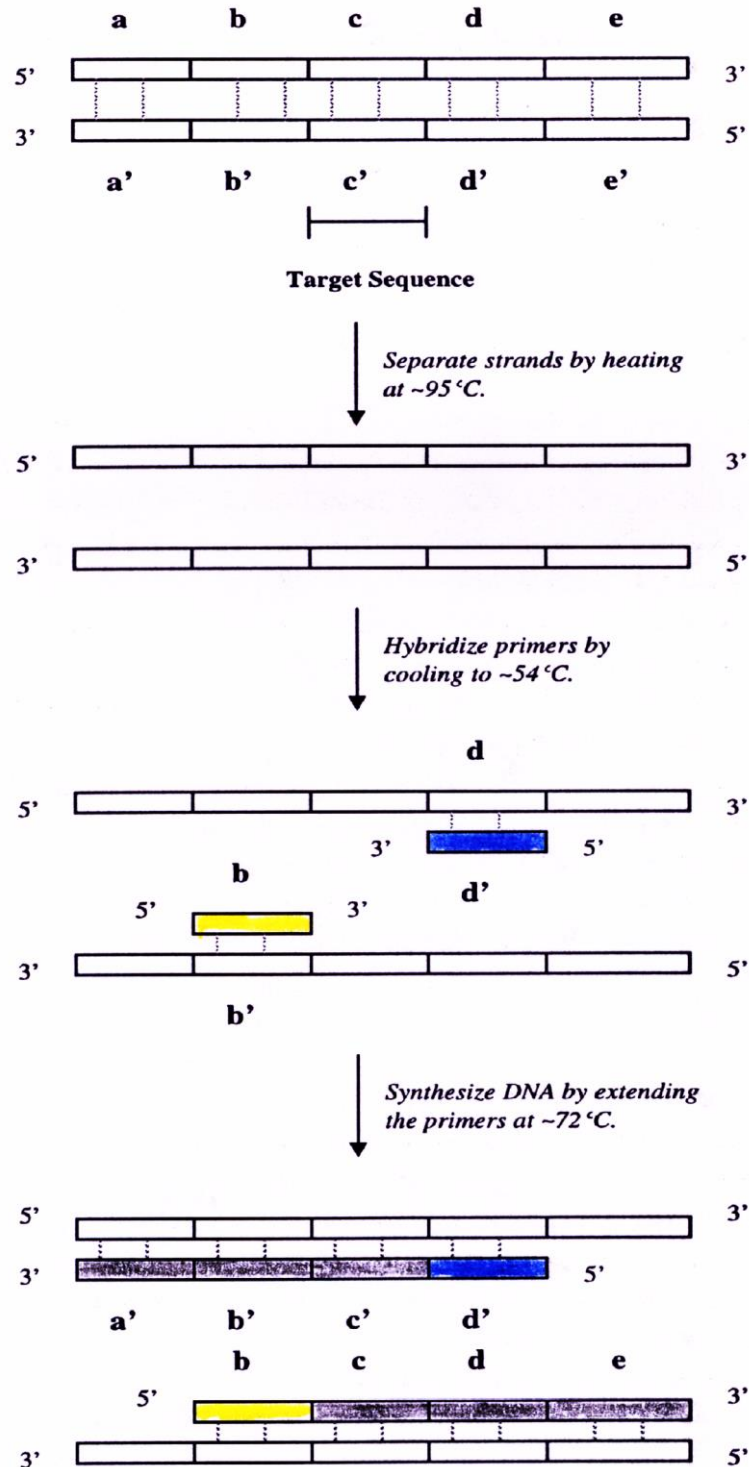

Figure 6.9. Polymerase chain reaction (PCR). The cycle consists of three phases: strand separation, hybridization of primers, and elongation of primers through DNA synthesis. Reactions were performed in a closed vessel. Cycle driven by temperature change. The sequences on one strand of DNA is characterized by abcde initial and complementary strand sequence with a'b'c'd'e'. Primary b are shown in yellow and primer d' in blue; novel DNA red.

1. **Denaturation (Strand Separation)**. The two strands of the parent DNA (and of the target sequence) are separated by heating the PCR mixture to 95 degrees Celsius for 15 seconds. This is represented by the breaking of the hydrogen bonds (dashed lines) between the DNA strands.
2. **Annealing (Hybridization of Primers)**. The solution was then cooled abruptly until the temperature reaches 54° C, so that any beginner can form a hybrid with the DNA strand. Beginner b form a hybrid with b' on one strand, and beginners d' d to form a hybrid with its complement strand. Due to the excessive number of very beginner, parent DNA duplex-duplex is not formed. Beginners have a typical length, which is 20 to 30 nucleotides.
3. **Primer Extension (DNA Synthesis)**. The solution was then heated until it reaches a temperature of 72° C, the optimum temperature for Taq DNA polymerase. Heat - resistant polymerase from *Thermus aquaticus* is derived, a bacterium termofil. The second extension occurs toward the beginner target sequence for the 3'end beginner d' dealing with c, and the 3'end dealing with a novice b c'. Polymerase lasted 30 seconds left. One new DNA strand is bcde and the other is a'-b'-c'-d'. thus both the target strand is replicated.

The third stage-Strand separation, Hybridization of Primers, and DNA synthesis can be repeated simply by changing the temperature of the reaction mixture. Thermostability polymerase allows PCR was performed in a sealed container; no reagent is added after the first cycle. PCR is a key characteristic that all new DNA strands act as a reference in the next cycle. Specifically, bcde formed in the first cycle acts as a reference for the synthesis b'-c'-d' in cycle 2 and subsequent cycles. Likewise, a'-b'-c'-d' to act as a reference for the synthesis bcd. At the end of the 3rd cycle, half the total number of DNA strands is a unit of bcd and b'-c'-d'. The number of DNA targets consisting of objectives flanked by novice beginners to grow exponentially in the next cycles. While other DNA sequences in the mix only increases linearly. Therefore after a few cycles, nearly all of the DNA is BCD. Ideally, after n cycles, the sequence was duplicated 2^n times. In less than 1 hour, can be generated perbanyakkan a million times after 20 cycles, and a billion times after 30 cycles.

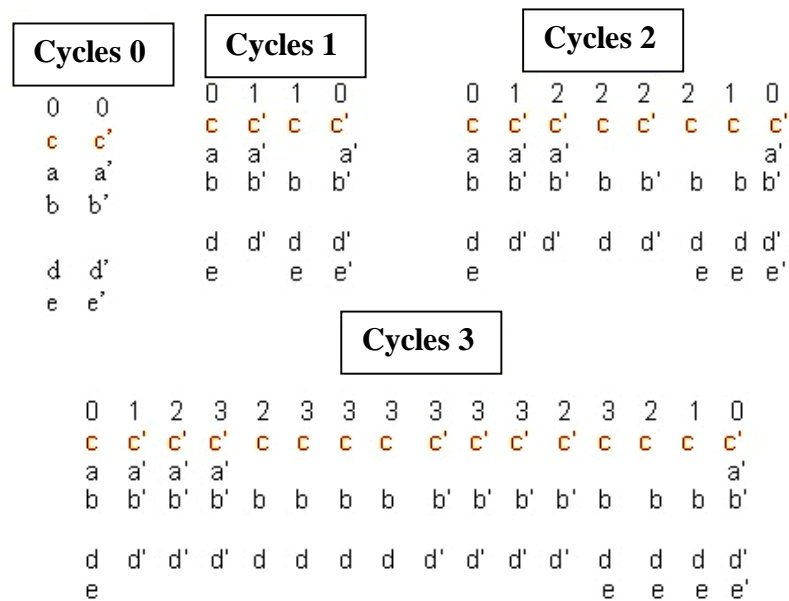

Figure 6.10. Product 3 cycles of polymerase chain reaction. The addition of primers b and d' produces multiplication target sequence and its complement c c' (both colored yellow) exponentially. The numbers indicate the order in which the cycles are generated.

There are several aspects that need to be considered from the DNA propagation method is remarkable. First, the order of the C target need not be known. I need to know only the sequences flanking B and D. Second, the target can be sized much larger than beginners. PCR has been propagated to a large target size of 10 kb. Third, to multiply the DNA beginners do not need a perfect complement of flanking sequences. When the sequence of a gene known to be possible to search for gene variations. With PCR, the group found similar genes. Fourth, PCR is specific for hybridization at high temperatures. The amplified only the DNA located between the beginner-beginners who have undergone hybridization. A gene whose DNA content of less than one millionth of the total DNA, can be obtained by using PCR. Fifth, highly sensitive PCR. The DNA molecule itself can be propagated and detected.

PCR is a very powerful technique in medical diagnosis, forensic, and molecular evolution. With the use of PCR, manufacture clones and determination of the DNA sequence to be much simpler. In addition, this innovative technique has been greatly to expand the scope and improve the technology of DNA recommendations. PCR may provide useful diagnostic information for the medicine. Bacteria and viruses can be detected by using a specific beginners. For example, PCR can reveal the presence of human imunodefesiensi virus-1 (HIV-1) in individuals who show no immune response to this pathogen, so it could not be detected in the antibody test. Finding the bacteria *Mycobacterium tuberculosis* in tissue specimens requires time and hard. But by PCR, 10 million germs of tuberculosis among human cells can be known easily. PCR is also a promising method for early detection of certain cancers. Mutations of genes controlling growth, such as the RAS gene, can be identified by PCR. Great ability to reproduce certain DNA regions can be very important to monitor cancer chemotherapy. Ideally, treatment

should be discontinued when the cancer cells have been removed, and immediately restarted if relapse again. PCR is ideal for detecting leukemias caused by chromosome rearrangement.

PCR is also very important in the field of justice and forensic medicine. DNA profile of an individual is very typical, since many genetic loci are highly variable in a population. Examples transplanted organs rejected if the type of HLA (human leukocyte antigens) and resepien not suitable donor. In the case of paternity and immigration, amplification of multiple genes by PCR is used to determine the biological origins. Analysis of blood stains and semen samples with PCR is helpful in cases of rape and molestation. In common scene hair. The root of the hair piece contains enough DNA for determination by using PCR.

In addition, by extending relic fragments are rare, PCR allows the reconstruction of DNA from ancient samples. More recently, the parts of several genes derived from Egyptian mummies 2400 years old and the archaeological remains of 7500 -year -old has been able to be read by PCR. The types of early human HLA a 'snapshot' of the population dynamics in the environment. So far, the oldest DNA that has been analyzed is derived from termites buried in yellow agate. DNA sample is 25-30 million years old. Ribosomal RNA gene sequences of fossil termites, which originated in the times Meosin shows the evolution of termites and cockroaches. DNA of ancient plants also have revealed a lot of information. An essential chloroplast genes from Magnolia fossils of the same age have been exhumed. Archaeology and molecular palaontologi have started on. PCR saga tells of ancient relics that have a lot of history to uncover.

D. Use of DNA Technology in Forensic Science

Forensic science involves the use of scientific procedures to collect evidence related to legal issues. The cells of all organisms contain deoxyribonucleic acid (DNA), and DNA from one organism is unique. Forensic scientists have learned to collect and analyze the DNA to help determine the organism-human as well as other types-were present at the scene of the crime or disaster. DNA can be used to achieve a specific purpose in a forensic investigation.

1. Identifying People Individuals

Because the DNA sequence of every person is unique, it can be matched to him like a fingerprint. According to Oak Ridge National Laboratory U.S. government, forensic scientists use DNA evidence to identify the person in criminal cases and paternity. DNA evidence is not always identify the suspect or the man as the father of a child, sometimes forensic evidence exonerates suspects or determines that the man is not the father of a child. DNA evidence can also be used to identify victims of disasters, such as natural disasters or terrorist attacks.

2. Identifying Animal Species

There are laws governing the conservation and hunting of endangered species. If a person suspected of illegally catching and transporting endangered species, forensic

scientists can use DNA analysis to confirm or rule out whether the animal specimens actually belong to protected species. A little piece of hair or even skin cells from these animals would be sufficient to produce accurate test results, so the transporter animal suspected or hunters do not need to be captured with the actual animals.

3. Other applications

DNA evidence can be used to identify the type of bacteria or parasites that may have caused the death of a person. This information can be useful in cases of medical negligence or parent. The origins of expensive consumables like liquor and caviars can be verified using DNA analysis. Finally, DNA samples can help medical professionals find a suitable donor organs for people who need an organ transplant to survive.

EXERCISE

To improve your understanding of the material above, do the exercises below!

- 1) Explain how the relationship between DNA with heredity, especially in relation to chromosomes and genes!
- 2) Based on the pictures below explain how DNA polymerase elongation talisis mengka-chain DNA 5' → 3'!

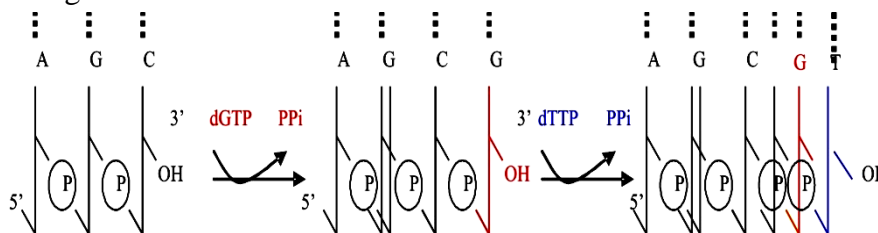

- 3) Explain how the PCR method in the study of the structure and function of DNA!
- 4) Relations between the two chains in the DNA helix double maintained by hydrogen bonds between pairs alkaline. Adenine (A) always pairs with thymine (T) and guanine (G) always pairs with cytosine (C). Can it be exchanged base pairs? Explain!
- 5) Explain briefly how the use of DNA in forensic science!

Instructions to Answer Exercise

If you have difficulty in answering the questions above back read the description of the structure and function of DNA. In what has been clear about the solution of the existing problems in practice.

RESUME

DNA is the molecule of heredity found in all organisms both prokaryotes and eukaryotes. In viruses, the genetic material consists of DNA or RNA. All cell DNA consists of two polynucleotide chains form a double helix is very long and wrapped around the same axis. Both strands of the double helix run in opposite directions. Sugar phosphate backbone of each strand of the double helix are on the outside, while the purine bases and pyrimidine contained inside. Relations between the two chains is maintained by hydrogen bonds between pairs alkaline. Adenine (A) always pairs with thymine (T) and guanine (G) always pairs with cytosine (C) thus, one strand of the double helix are complementary to the other strand. Genetic information is encoded in the sequence of bases along a strand. Most of shaped circular DNA molecules. The axis of the circular DNA double helix can form superhelical coiled itself. DNA supercoiled DNA is more compact than the slack.

In DNA replication, the two strands of the double helix and split open when newly synthesized chains. Each parent strand acts as a mold for the formation of a new complementary strand. So DNA replication is semiconservative each molecule offspring receive one strand of the parent DNA molecule. DNA replication is a complex process involving many proteins, including a variety of DNA polymerases. Diaktitkan precursor in the synthesis of DNA is 5'-triphosphate four deoksiribonukleosida. The new strand is synthesized in the 5' → 3' by nucleophilic attack by the 3'-hydroxyl end of the primer strand at the innermost phosphorus atom of the incoming triphosphate deoksiribonukleosida. The most important of DNA polymerase catalyzes the formation of phosphodiester bond only if the base on the incoming nucleotide is the complement of bases in the template strand. In other words, the DNA polymerase is an enzyme that is directed by the mold.

CHAPTER 7 STRUCTURE AND FUNCTION OF RNA

A. RNA Structure

The basic components of RNA or ribonucleic acid are the same than for DNA with two major differences. The pyrimidine base uracil replace thymine and ribose replace deoxyribose. Adenine and Uracil for a base pair formed by two hydrogen bonds. RNA has 3 main structures. The primary Structure that refers to the exact sequence of nucleotides. The secondary structure refer to the basepairing interactions with in a single RNA molecule. Finally the tertiary structure refers to the precise three dementional structure of the RNA.

RNA is a crucial linchpin of many cellular activities, including the process by which genetic material is expressed as proteins. Genes in prokaryotic and eukaryotic organisms all made of DNA. In the viral genes are made of DNA or RNA (ribonucleic acid). RNA, like DNA, is a long unbranched polymer consisting of nukleotidanukleotida are concatenated with bond 3' → 5' phosphodiester (Figure 3.8). Covalent structure of RNA differs from DNA in two respects. As read from its name, the sugar units in RNA form of ribose instead of deoxyribose. Ribose containing a 2'-hydroxyl group is not contained deoxyribose. Another difference is that one of the four major bases in RNA is uracil (U) replaces thymine (T). Uracil, thymine such, can form a base pair with adenine, but does not contain methyl groups contained in thymine. RNA molecules can form Figure 7.1. The structure of part of a single strand or double strand.

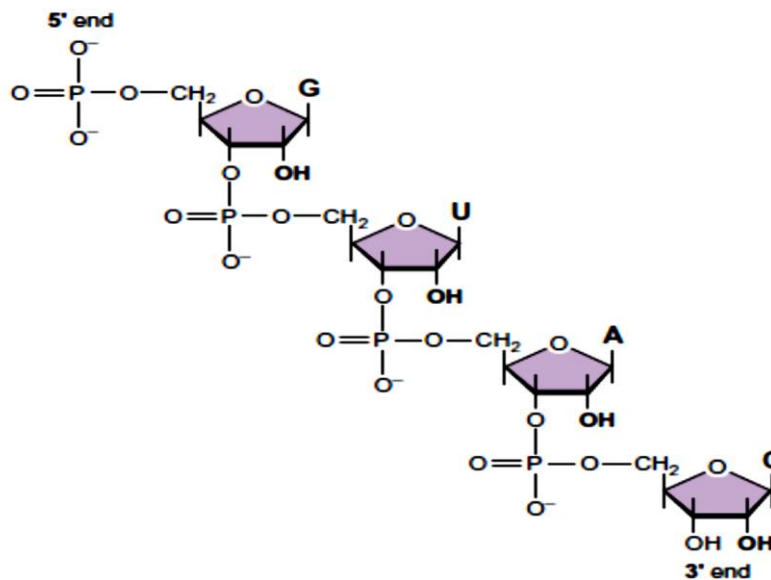

Figure 7.1. . Structure of the backbone of RNA, composed of alternating phosphate and ribose moieties.

RNA can not form a double helix B-DNA -type sterile because of interference by the 2'-hydroxyl group on ribosanya units. However, modification of RNA can form a double

helix and away alkaline pairs makes an angle of about 20° greater than the line perpendicular to the axis of the helix, a structure similar to A-DNA. RNA compose 5-10 % of the dry weight of the cell. Basically, there are two major groups of living things that make up RNA, RNA is the genetic and nongenetic RNA. Is the difference between the two RNA?

1. RNA genetic

Genetic RNA has a function similar to DNA, the genetic molecule that is overall responsible for bringing all the genetic material, such as those held by the DNA. In other words, this RNA serves as the DNA. Genetic RNA is only owned by certain living organisms that do not have DNA, as in some kind of virus.

2. RNA nongenetic

Nongenetic RNA is RNA that does not act as DNA. RNA nongenetic owned by the genetic material of living things are regulated by DNA. In this group of living beings, in the cell are DNA and RNA.

Based on the location and function, non-genetic RNA can be divided into three kinds, namely messenger RNA, ribosomal RNA, and RNA transfer.

- a. Messenger RNA or "messenger RNA" (mRNA) is a nucleic acid that form a single band and is the largest or longest RNA that acts as a mold pattern -forming polypeptide. The main function of mRNA is carrying the genetic code from DNA to the ribosomes. mRNA also serves as a template in the synthesis of proteins.
- b. Transfer RNA (tRNA) is the shortest RNA that acts as a translator codons of mRNA. In addition, functional tRNA binding amino acids are assembled into proteins and transport it to the ribosome. In tRNA there is a section dealing with the so-called anticodon and codon that serves as a binding part of amino acids.
- c. Ribosomal RNA (rRNA) is the RNA with the highest number and constituent ribosomes. RNA is a single band, not branched, and flexible. More than 80% of the RNA is rRNA. RRNA function is still largely unknown, but is thought to have an important role in the process of protein synthesis.

Table 7.1 describe some of the characteristics of the three basic types of RNA for a simple bacterial cells such as E. Coli. RNA molecules of eukaryotic cells is the same basic type. Unlike DNA, the RNA molecule generally consists of a single fiber although portions of the RNA fiber can be rolled back to form helical structures are small. We will describe the structure and function of RNA shapes in this learning activity.

Table 7.1.
Physical properties of nucleic acids from Ecoli

Type the total	number of unit boundaries NMP	percentage of RNA in cells
t-RNA	75 – 90	16
m-RNA	75 - 3000*	2
r-RNA	5 S : approximately 100 16 S : approximately 1500 23 S: approximately 3100	82

Description:

- * The size-m-RNA molecule is determined by the number of remaining amino acids in the protein to be synthesized.



The term 5 S, 16 S, and 23 S refers to the rate of certain molecular components of a ribosomal RNA preparations settle, or tossed in a high gravitational field ultrasentrifus. Heavier molecules (large) settle more quickly and therefore have more fnggi sedimentation coefficient. Sedimentation coefficient expressed in Svedberg units (S) is taken from the name of the Swedish physicist T. Svedberg who created ultrasentrifus in 1925.

In addition to the above forms, also RNA is the genetic material in a particular virus. As in ribosomal RNA is a complex protein structure, the virus-was a collection of nucleic acid and protein molecules.

Nucleic acids are often found in natural proteins join. In somatic cells of plants and animals. Chromosomal DNA or chromatin proteins fused with. Included in this DNA protein combined there is a group called histones. Histones contain mostly the remains of lysine, arginine, or both depending on what the histones, and thus makes a very complex with clusters of negatively charged phosphodiester backbone of DNA. Because of the interaction between DNA and histones are not any in, then the eukaryotic chromosome is a nucleic acid-protein complex truth. Nucleic acid complexes are other important proteins including ribosomes and viruses.

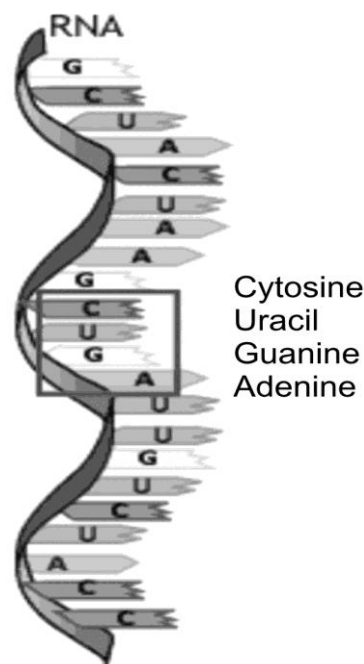

Figure 7.2 . RNA protein structure.

1. Ribosomes

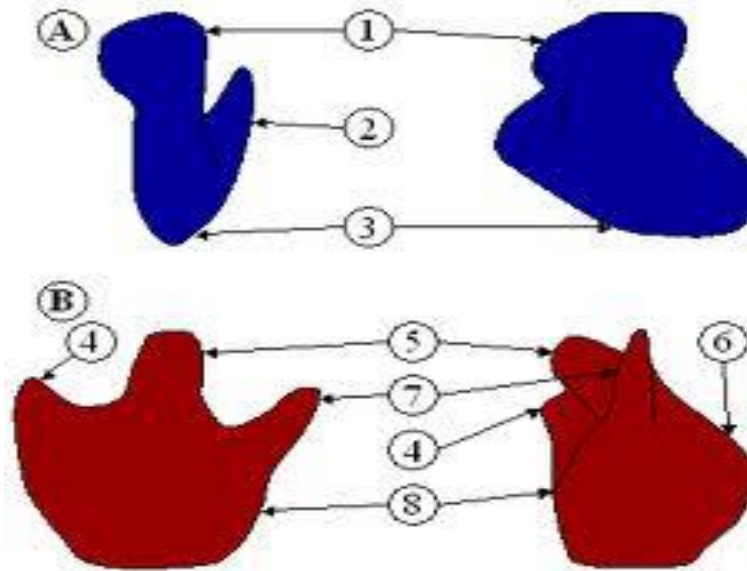

Figure 7.3 . Dissociation of ribosomes E. Coli into r-RNA and proteins. With state matching requirements of ribosomal RNA and proteins were separated spontaneously recombine to form small ribosomal units are intact and functioning.

Ribosomes are subcellular structures where protein synthesis takes place. If the ribosomes of prokaryotic cells differ in size and structural details of the eukaryotic ribosome, but the important basic things are the same for both. Ribosomal structure of E. Coli has been investigated extensively. Intact 70 S ribosome consists of two subunits, the 50 S and 30 S subunits. Both of these units combine to form a complete ribosome diameter of about 200 and a molecular weight of about 2.5×10^6 . Nucleoprotein structure of the ribosome can didisosiasikan by treatment with chemicals into the parent components, as shown in Figure 3.10. The investigation of the rearrangement of ribosomal subunits subunits-30 S and 50 S has been proved that the ribosomal proteins are important for the structure and function of the ribosome.

2. virus

Viruses are not plants, animals, or bacteria, but they are the quintessential parasites of the living kingdoms. Although they may seem like living organisms because of their prodigious reproductive abilities, viruses are not living organisms in the strict sense of the word. The virus is contagious and inert particles consisting of nucleic acid molecules are surrounded by a protective protein layer. Protein coating protects the viral nucleic acids against nuclease action.

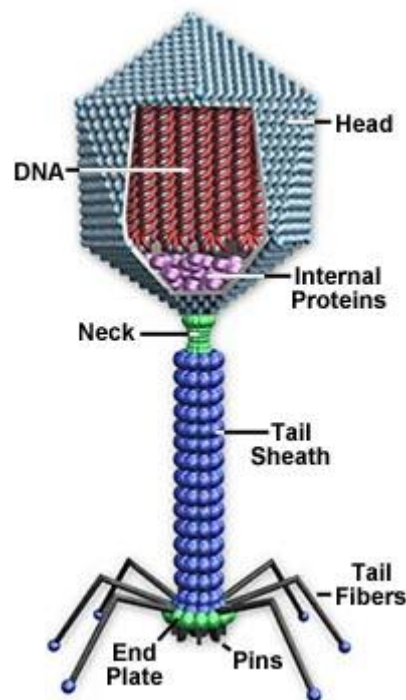

Figure 7.4. Bacterial structure

All viruses contain nucleic acid, either DNA or RNA (but not both), and a protein coat, which encases the nucleic acid. Some viruses are also enclosed by an envelope of fat and protein molecules. In its infective form, outside the cell, a virus particle is called a virion. Each virion contains at least one unique protein synthesized by specific genes in its nucleic acid. Viroids (meaning "viruslike") are disease-causing organisms that contain only nucleic acid and have no structural proteins. Other viruslike particles called prions are composed primarily of a protein tightly integrated with a small nucleic acid molecule. Viral proteins can also perform structural functions such as in the case of bacterial viruses T2 -eating bacteria. Viruses can not implement energy metabolism and may be in a steady state only by infecting a host cell. When a virus infects a host cell, the viral genetic material (DNA or RNA) injected into the cell. Cell protein and nucleic acid biosynthetic tool then produces a new viral nucleic acids and proteins using genetic information carried by DNA and RNA were injected. The preparation of spontaneous viral proteins and nucleic acids means there is formation of new virus. Many viruses eventually destroy the host cell and thus are said to be pathogenic or plant diseases. Some viruses cause host cells develop patterns of growth and cell surfaces are not normal. This is termed as oncogenik virus or viruses that cause tumors.

The nature of viruses wasn't understood until the twentieth century, but their effects had been observed for centuries. British physician Edward Jenner even discovered the principle of inoculation in the late eighteenth century, after he observed that people who contracted the mild cowpox disease were generally immune to the deadlier smallpox disease. By the late nineteenth century, scientists

knew that some agent was causing a disease of tobacco plants, but would not grow on an artificial medium (like bacteria) and was too small to be seen through a light microscope. Advances in live cell culture and microscopy in the twentieth century eventually allowed scientists to identify viruses. Advances in genetics dramatically improved the identification process.

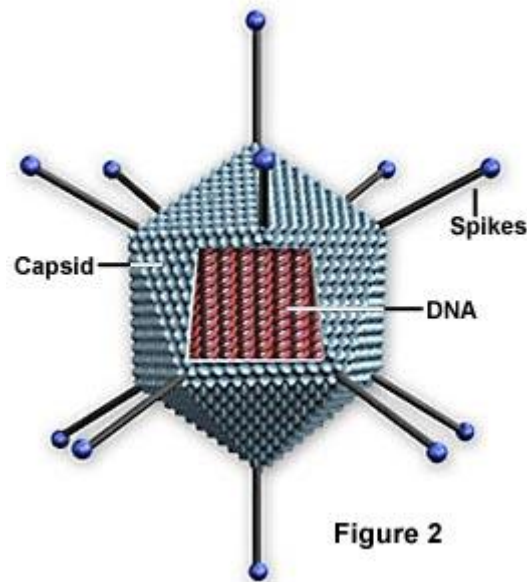

Figure 7.5. Animal virus structure

Nucleic acid-protein structure of most viruses are well known. Some viruses are rudimentary which has a small nucleic acid with only 3 genes. Other viruses have structures more complicated and therefore more genes in some cases as many as 250 or more.

The first virus was investigated as a ribonucleoprotein tobacco mosaic virus (TMV) in 1935. The structure is representative of a common group of viruses that have a helical shape like a stick. TMV describes common types of viral structures: nucleic acid surrounded by a structural skin that is composed of many identical protein molecules or many of the several kinds of proteins.

TMV consists of a helical structure, a single RNA very tightly surrounded by approximately 2130 identical protein subunits, to produce viral particles with a total length of about 3000 and a diameter of about 180. With state matching requirements, a protein subunit of RNA can dissociate and then recombine to produce a virus that is spread again. This is an example of self-assembly. Supermolecular complexes are often observed in biochemistry and molecular biology of viral structures can also be as complex as in the case of bacteriophage T₂. DNA from bacteriophage T₂ was covered in a capsule by a protein shell that has an icosahedral shape. It is an unusual arrangement in most types of viruses.

B. Properties and Functions RNA

Because the cells multiply by division process, the DNA must reproduce the exact same form in each cell from generation to generation. In addition the functioning of a normal individual cells required the use of genetic information contained in DNA to direct the biosynthesis of the enzyme protein. Both of these define the role of the genetic material in cells and cause the central dogma of molecular genetics. This opinion is an outline of the role of DNA and RNA in the inheritance of genetic information from one form of deposits into the end of the primary structure of a protein molecule, as shown in Figure 7.6 .

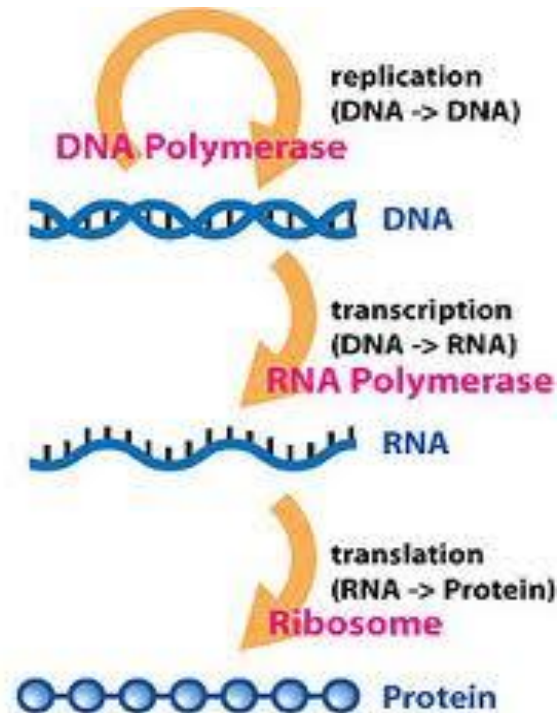

Figure 7.6 . The central dogma of molecular genetics. The arrows depict the direction of the flow of genetic information. Dotted lines show the special circumstances that deviate from this chart.

Three main processes shown in Figure 7.6 , ie replication, transcription, and translation:

1. Replication involves coupling linearly monomer units of DNA to replicate or establish proper coffee from a long series of DNA structure. This process allows the formation of two molecules of DNA during cell division children, each one a proper coffee from the parent DNA.
2. Transcription involves coupling linearly RNA monomer units., Or ribo-nucleotides, using a typical small parts (gene) of the DNA strands as a model. RNA molecules not only provide mold work for the biosynthesis of proteins, but also worked as a special carrier for amino acids and also equip the place where the link protein synthesis to take place.

3. Include translational coupling in a linear amino acid monomers, using RNA as a distinctive type of mold and other types of typical RNA as carrier and amino acid modifiers. This is in accordance with the actual process of protein synthesis.

Chart shown in Figure 7.4 . also includes other processes, which are found by recent studies: in certain circumstances, the RNA can act as a mold for DNA biosynthesis process termed reverse transcription. In this case it is clear that nucleic acids play an important role in protein biosynthesis.

In Figure 7.4 we have seen how the flow of genetic information in a cell takes place from DNA to RNA. Transcription is a specific unit of genetic information in DNA that lead to the formation of an RNA molecule with a single fibrous acid sequence of bases complementary to the DNA strand transcribed parts. We can imagine the existence of a DNA strand is divided into short sections which are interconnected. Each section, or gene consists of a sequence of bases that make a code for a unique RNA molecules. RNA molecules corresponding to a particular gene, may constitute one of the three types of RNA, namely m-RNA, r-RNA and t-RNA, as discussed earlier.

The biggest class of the vast gene in chromosome coding for molecules m-RNA, thus providing a major briefing for protein synthesis. Genetic maps that show the places of many gene corresponding to certain proteins, it has been concluded for certain bacteria, including E. Coli.

The process of synthesis of RNA molecules by transcription of the DNA template in question can be divided into several stages.

Phase 1. The enzyme RNA polymerase bound to a specific sequence of bases, or mark the beginning, the beginning of the gene is undergoing transcription. This places the beginning of a sequence rich in pyrimidine bases and has about 10 nucleotides. The binding of RNA polymerase at the site of the beginning of the roll causes the opening of the double helix of DNA in a nutshell. For any given gene, only one strand of the double helix serves as a template for transcription. RNA polymerase from E. Coli producing all three types of cellular RNA. In mammalian cells it is evident that there are several different RNA polymerases. RNA polymerase E. Coli has a molecular weight of approximately 5×10^5 and consists of five sub-units.

Phase 2. Substrates for RNA polymerase reaction, ATP, GTP, UTP, and CTP, a complementary base pair to base on one of the parts of DNA. The specificity of DNA base pairs allows the mold to act as the addition of ribonucleoside triphosphate in the correct order to the growing RNA strand. RNA polymerase catalyzes the formation of phosphodiester relationship between ribonucleoside triphosphate and 3'-OH end of the growing RNA strand. Imposition of pyrophosphate hydrolysis followed helped provide the driving force for this reaction. Workings of RNA polymerase together with the workings of DNA polymerase 1. Growth as well as the RNA strand of DNA, takes place in the 5' → 3'.

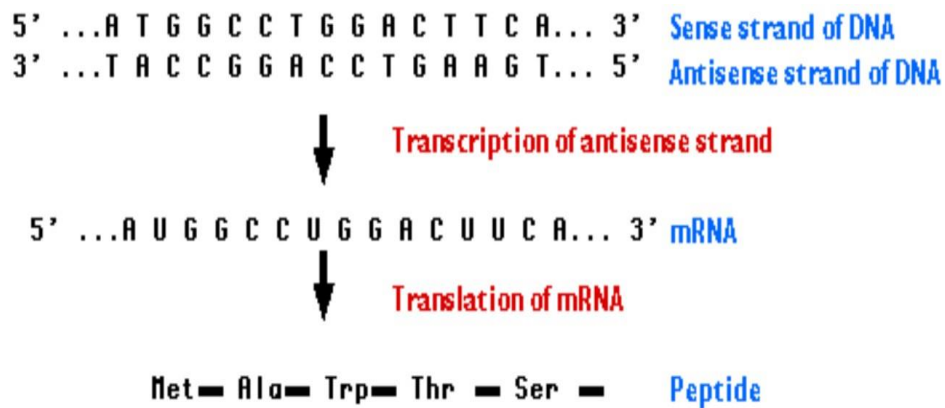

Figure 7.7. The process of RNA transcription.

- Phase 3. While RNA polymerase moves down the DNA strands obey, then the hybrid RNA / DNA duplex generated, open coil, and the DNA template strand double helix of DNA reshaping / DNA is more stable with a complementary strand of chromosomes. At the end of the gene, a specific sequence of bases led to the cessation of transcription and RNA polymerase escape of the DNA molecule. In some cases it is evident that specific proteins, namely the factor p, may be involved in the settlement process.
- Stage 4. Once synthesized RNA molecules, is likely to be modified chemically. For example, it is known that 18 S and 28 S ribosomal RNA r-mammals is the result of methylation and cleavage of 45 S single pioneer. This is reminiscent of the formation of zymogen or inactive pioneer of a certain enzyme proteins. There is evidence that the t-RNA molecules produced by the selective cleavage of larger RNA molecules. In addition, the bases that are less important especially ordinary t-RNA, may be the result of a chemical change occurs after transcription of the pioneers of t-RNA

1. Transfer RNA (t-RNA)

Transfer RNA (t-RNA) is the smallest form of RNA. Because of its size, it is sometimes called s-RNA (small-RNA), as a result that the liquid remains in the upper part of the solution, whereas other forms of RNA (which are heavier) precipitated by ultra centrifugation. Each of the 20 amino acid molecule has at least one special t-RNA, which is useful for transporting t-RNA molecules to the site of protein synthesis before and ensures proper placement in the amino acid sequence of the protein being synthesized. Figure 7.8 gives a schematic overview of t-RNA molecule. Anticodon arch shown in this image contains a base triplet (anticodon) that is complementary to one codon for alanine. Anticodon plays a key role in protein synthesis.

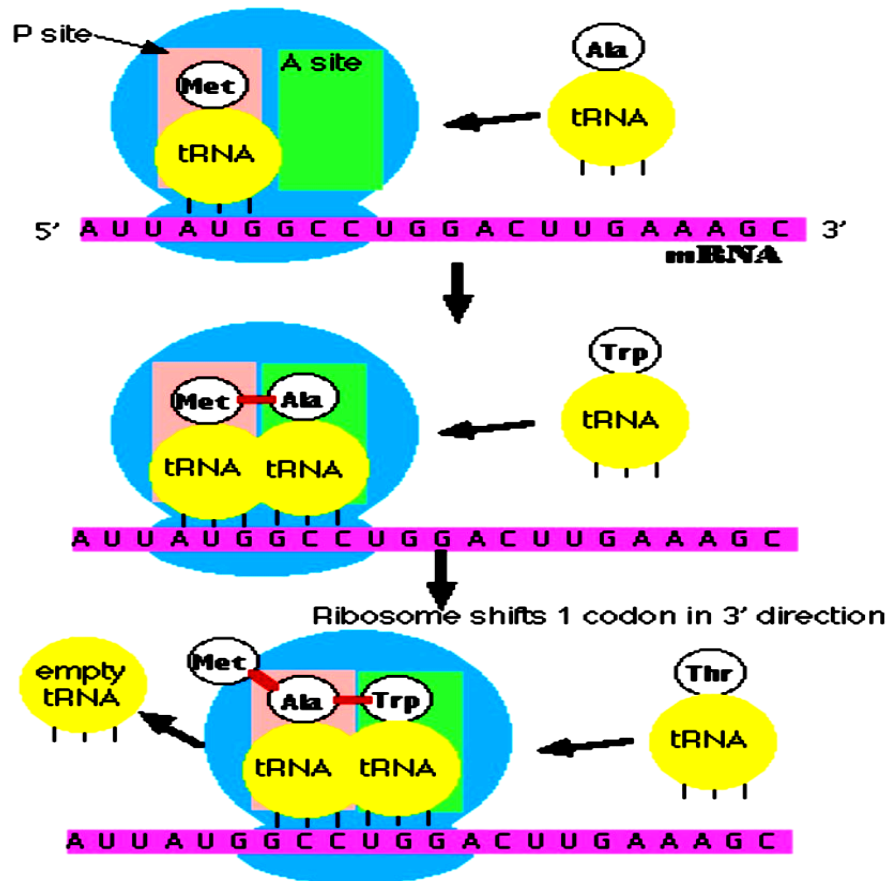

Figure 7.8. Schematic representation of t-RNA molecule.

Model "clover leaf" structure of t-RNA are shown in Figure 7.9 is a two-dimensional approach of the true form. By using X-ray diffraction analysis has determined three-dimensional structures of a number of t-RNA.

Note that in Figure 7.8 for the alanine anticodon is a triplet 3'CGI5', which is complementary to the codon 5'GCC3'. (I mean inosine). The researchers have a great deal of evidence that the third position in the anti-codon (bases on the 5'end of the anti-codon) have much more freedom to move than the first two bases.

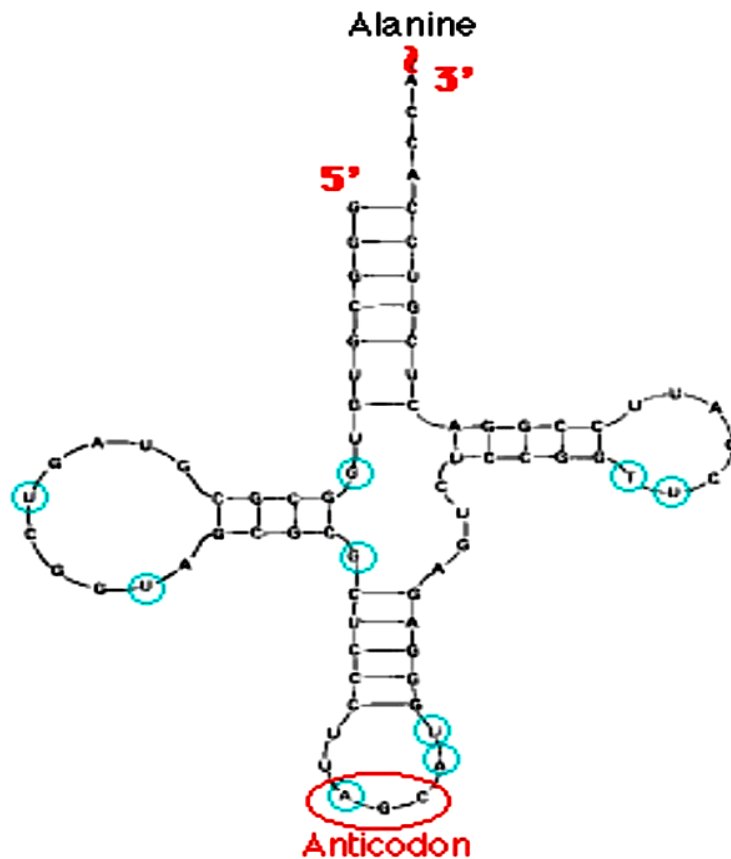

Figure 7.9. Model cloverleaf structure of t-RNA.

This observation is the concept of wobble and explain why the same anticodon triplet in t-RNA molecules can be specified with a range of base pairs of different triplet codons. As we shall see, when we discuss in detail the genetic code, then a particular amino acid can have more than one triplet codon. In the case of aminoacyl t-RNA molecules are shown in Figure 7.4 the codons GCU, GCC, GCA, GCG all code for alanine. From the fourth codon, anti-codon is shown in Figure 7.4 will be paired bases with GCU, GCC, and GCA. Note that both bases in three codons are equal (CG), and only the third different position. The interaction between inosine, alanine anticodon bases and wobble in each of the three bases, which can be paired bases with a base earlier. It is important to note that the potential of the double base pair at the third codon position means that anti aminoacyl t-RNA molecules of the same can be paired with up to three base codons, all of them are specialized with the same amino acid.

The results of the bond order and the example CGI third each corresponding codon is not the same for each. Variations in the binding ability can be useful as a basis for controlling the rate of protein synthesis. It is possible therefore that the rate of incorporation of a specific amino acid to a growing protein chain, which is determined by the possible codons are used.

2. Messenger RNA (m-RNA)

M-RNA molecule size depends on the amount of residual amino acids in a protein molecule requires the m- RNA as a template. Synthesis of a protein containing 500 amino acids remainder obviously be taken care of by the m-RNA molecules that have at least 1500 (3×500 bases).

In talking about the structure of t-RNA seen that a special anticodon in t-RNA molecules corresponding to a particular amino acid is taken along. In the base sequence of mold work for the synthesis of proteins, namely m-RNA are base triplets, or codons t-RNA complementary to the anticodon. The location of each codon on m-RNA strand corresponds to the corresponding amino acids in the primary structure of the protein, which requires m-RNA as a template.

Changes in m-RNA in bacteria took place very quickly, with an average age showed about 2 minutes. While the transcription of a particular gene produces only one molecule of m-RNA at all, but the m-RNA molecules can direct the biosynthesis of many protein molecule simultaneously.

The relationship between the aminoacyl t-RNA and m-RNA is shown schematically in Figure 7.10. This image recapitulate what has been said about the role of the codon-anticodon interaction in the correct placement of the amino acids in the protein chain. Now that has been discussed about the” parts” and templates for the synthesis of proteins, the layout remained discuss ongoing protein synthesis is the ribosome.

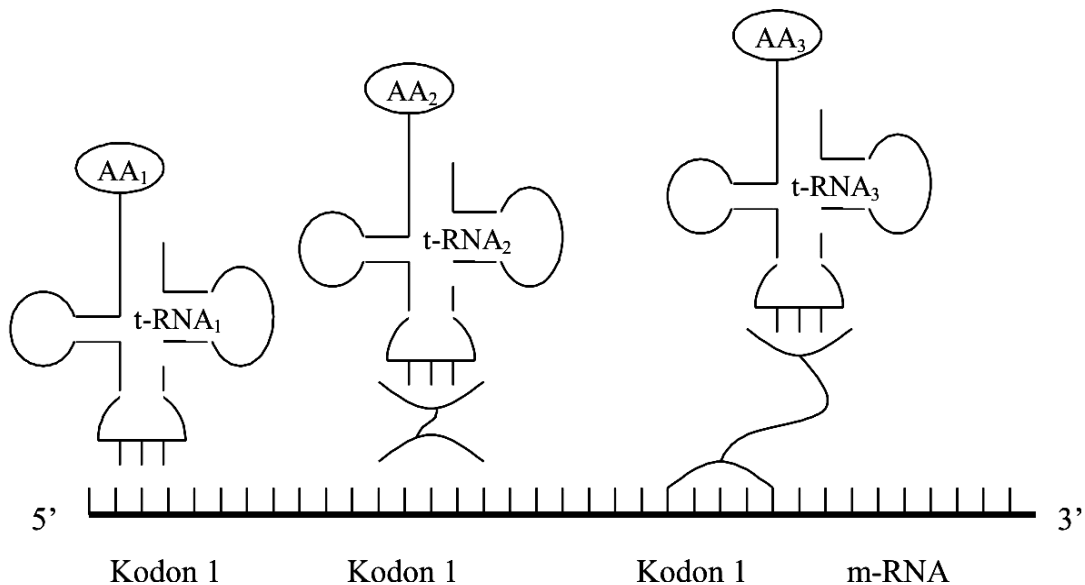

Figure 7.10. Amoniasil t-RNA molecule and its relationship with the m-RNA. High specificity in terms of codon-anticodon base pairing ensure the correct position of the t-RNA molecule ammoasil along the mold m-RNA.

3. Ribosomal RNA (m-RNA)

Protein synthesis occurs on the surface of RNA-protein complexes, known as ribosomes. The whole function of the ribosome is to ensure the correct orientation between the mold and the m-RNA molecules among t-RNA which was fastened to the mold. Therefore, the ribosome binds specifically m-RNA, t-RNA amino acid coming in, and part of the growing chain, everything in the correct orientation stereokimiawi. Moreover, the ribosome contains certain enzymes called translocase, which causes the ribosome moves along the m-RNA strand during protein synthesis takes place. In a prokaryote such as E. Coli approximately, 15,000 ribosomes distributed throughout the cytoplasm. Ribosomes E. Coli intact particles have a weight of 3×10^6 Dalton and termed the 70 S ribosome, because the nature of the sediment in ultracentrifuge. Shape throughout the estimated 70 S ribosomal shown in Figure 7.11.

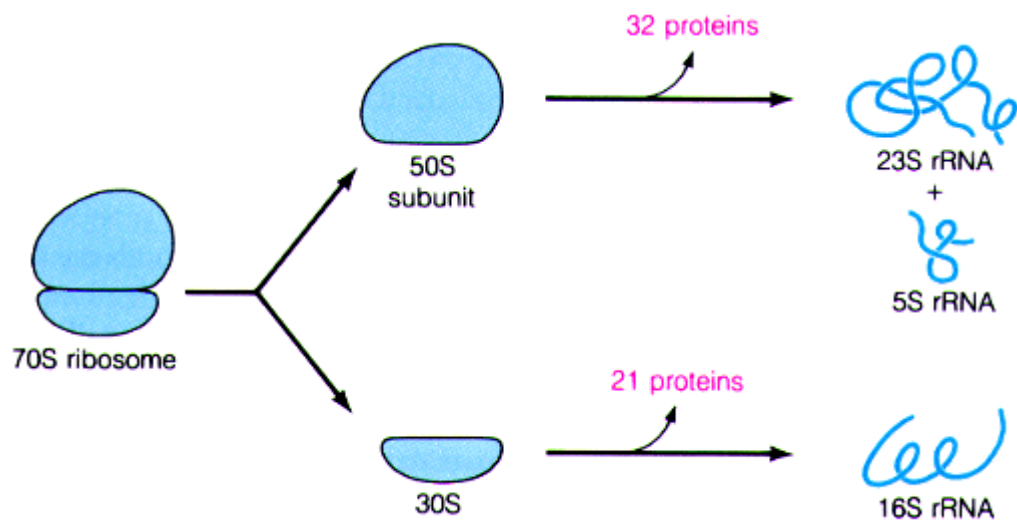

Figure 7.11. E.Coli ribosomes Structure, each showing the subunits dissociation into its components r-RNA and protein. Note that an intact 70 S ribosomes are formed, when the subunits subunits bind themselves to the m-RNA. (Note also that the sedimentation coefficient depends on both the molecular weight and molecular shape. Due to the price of the S ribosomal subunits did not produce the amount of the price S of the intact ribosome).

In the absence of m-RNA and at low concentrations of Mg^{2+} , ribosomal 70 S dissociates into two subunits: the subunits 50 S (heavy particles approximately 2×10^6 Dalton) and the subunits 30 S (heavy particles approximately 1×10^6 Dalton). Ribosomal RNA and protein components of each subunits can didisosiasikan and isolated by chemical means are appropriate, and fractionation. The results of the separation of the components of each ribosomal subunits of E. Coli is shown in Figure 7.9. It is interesting that in the right circumstances it is possible for spontaneous rearrangement of the subunits of ribosomal subunits-30 S and 50 S are active. So it is

clear that the arrangement is complex and highly specific of proteins and nucleic acids and ribosomes caused by the self-assembly of components.

In eukaryotic cells, protein synthesis does not occur in the cytoplasm, but also to the limited size of mitochondria and chloroplasts inside. Ribosomes from chloroplasts and mitochondria similar to the 70 S ribosome of prokaryotes, the ribosomes in the cell cytoplasm of eukaryotic cells are larger and more complex. Like the 70 S ribosome of prokaryotes, the ribosomes of the eukaryotic 80 S subunits dissociate into a large (60 S) and a small subunits (40 S). 60 S subunits containing three RNA molecules: 5 S, 7 S, and 23 S. Subunits 40 S has a 18 S RNA molecules are single. In addition there ribosomal proteins within the nucleoprotein complex structure of the eukaryotic ribosome.

In a eukaryotic cell, such as hepatocytes, ribosomes are usually found in the endoplasmic reticulum communion with, which is a structure that is composed of many channels extending in all directions throughout the cytoplasm. Figure 7.12 shows the endoplasmic reticulum and ribosomes.

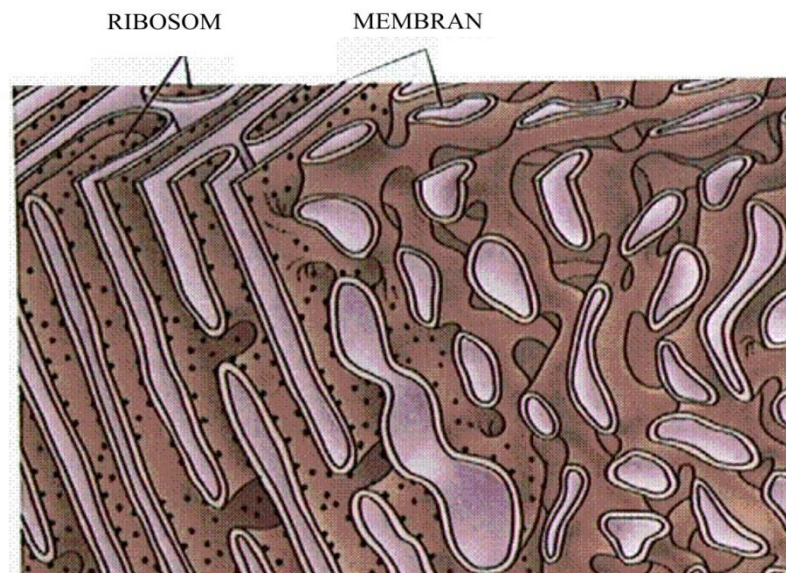

Figure 7.12. Endoplasmic reticulum. Note ribosomnya, which appears as granules lined-row all the way across endoplasmic reticulum.

Not looking at what types of cells, then the workings of the ribosome in protein synthesis is common. Both ribosomal subunits to form a complete ribosome when bound to the m-RNA. M-RNA ribosome complex is a unit causes the active protein synthesis. The relationship between ribosomes, m-RNA and t-RNA is usually more than one ribosome bound to the m-RNA strand. It allows the simultaneous formation of multiple proteins from the same mold by means of "assembly line". This complex is called polisom Multi-ribosom/m-RNA, and has been directly observed by electron microscopy. Formation of m-RNA by transcription of the DNA and the embodiment of m-sequences of RNA into protein structure by ribosomal protein synthesis closely coordinated with respect to time and place, at least in the E. Coli. While the 5' end of

the m-RNA newly formed chipped from the DNA template, then binds to ribosomal subunits and protein synthesis begins though mold m-RNA is being made .

Components of DNA and RNA have many similarities. However, due to different functions, they also have some differences, especially in terms of layout, structure, content, function, and chemical composition. These differences can be learned on the Table

Table 7.2 Differences of DNA and RNA

NO	OBJEK	DNA	RNA
1	Location	Cell nucleus	cell nucleus, cytoplasm, ribosomes
2	shape	Double spiral band	Single band
3	Sugar components	deoxyribose	Ribose
4	Size	Very Long	Short
5	nitrogen bases	Purines: Adenine, Guanin	Pirimidin: Cytosine, Uracil
6	levels	are not affected by the rate of protein synthesis	Changes according to the speed of protein synthesis
7	Function	Control heredity and protein synthesis	protein synthesis

EXERCISE

To improve your understanding of the material above, do the exercises below!

- 1) Explain in brief what is the difference between genetic and non- genetic RNA!
- 2) Explain the difference between the 3 kinds of RNA, namely t-RNA, m-RNA, r-RNA and!
- 3) Explain what the function of ribosomes?
- 4) Explain the stages of the process of synthesis of RNA molecules by transcription of the DNA template!
- 5) Explain schematically how the genetic information of DNA and RNA occurs through!

Instructions to Answer Exercise
--

If you have difficulty in answering the questions above back read the description of the structure and function of DNA. To help your understanding read the following explanation.

- 1) genetic RNA has a function similar to DNA, the genetic molecule that is overall responsible for bringing all the genetic material, such as those held by nongenetic DNA, while RNA is RNA that does not act as DNA. RNA nongenetic owned by the genetic material of living things are regulated by DNA. In this group of living beings, in the cell are DNA and RNA.
- 2) The difference between the three kinds of cellular RNA
 - a) Messenger RNA (m-RNA) that act as templates for the synthesis of the protein chain.
 - b) Ribosomal RNA (r-RNA) which acts as a structural component of nucleic acids to the ribosome as a protein synthesis took place.
 - c) Transfer RNA (t-RNA) which act as carriers of specific amino acids in the polypeptide chain formation.
- 3) Ribosomes are subcellular structures where protein synthesis takes place.
- 4) Phase 1. The enzyme RNA polymerase bound to a specific sequence of bases, or mark the beginning, the beginning of the gene is undergoing transcription
 Phase 2. Substrates for RNA polymerase reaction, ATP, GTP, UTP, and CTP, a complementary base pair to base on one of the parts of DNA
 Phase 3. While RNA polymerase moves down the DNA strands obey, then the hybrid RNA / DNA duplex generated, open coil, and the DNA template strand double helix of DNA reshaping / DNA is more stable with a complementary strand of chromosomes.
 Stage 4. Once synthesized RNA molecules, it may be modified chemically. For example, it is known that 18 S and 28 S ribosomal RNA r-mammals is the result of methylation and cleavage of 45 S single pioneer.
- 5) To understand this matter see again Figure 7.1. . The central dogma of molecular genetics.

RESUME

RNA, like DNA, is a long unbranched polymer composed of nucleotides which continued to bond 3' 5' phosphodiester covalent structure of RNA differs from DNA in two respects. As read from its name, the sugar units in RNA form of ribose instead of deoxyribose. Ribose containing a 2'-hydroxyl group is not contained deoxyribose. Another difference is that one of the four major bases in RNA is uracil (U) replaces thymine (T). Uracil, thymine such, can form a base pair with adenine, but does not contain methyl groups contained in thymine. RNA molecules can form a single strand or double strand.

There are three kinds of cellular RNA, namely:

1. Messenger RNA (m-RNA) that act as templates for the synthesis of the protein chain.
2. Ribosomal RNA (r-RNA) which acts as a structural component of nucleic acids to the ribosome as a protein synthesis took place.
3. Transfer RNA (t-RNA) which act as carriers of specific amino acids in the polypeptide chain formation.

RNA is also the genetic material in a particular virus. As in ribosomal RNA is a complex protein structure, the virus-was a collection of nucleic acid and protein molecules.

Ribosomes are subcellular structures where protein synthesis takes place. If the ribosomes of prokaryotic cells differ in size and structural details of the eukaryotic ribosome, but the important basic things are the same for both. The virus is contagious and inert particles consisting of nucleic acid molecules are surrounded by a protective protein layer. Protein coating protects the viral nucleic acids against nuclease action. Three main processes in genetic information, namely:

1. Replication involves coupling linearly monomer units of DNA to replicate or establish proper coffee from a long series of DNA structure.
2. Transcription involves coupling linearly RNA monomer units., Or ribonucleotides, using a typical small parts (gene) of the DNA strands as a model.
3. Include translational coupling in a linear amino acid monomers, using RNA as a distinctive type of mold and other types of typical RNA as carrier and amino acid modifiers.

CHAPTER 8

FORCE ON HUMAN BODY

There is a great demand for information on the dynamic ability of the human body in various areas. In ergonomics such data are used to design various devices and tools for daily use. In medicine they are used for the design of rehabilitation tools. Also in industries such data are necessary to know in what kind of environment a human can work safely and comfortably without harming the body. The human body may be subject to loads externally applied in addition to gravitational and inertial force actions. At any section of a limb or body part, the resultant force and moment may be calculated from a consideration of the relevant loadings to one side of the section.

Force is a general concept that can sense intuitively. We are often aware of the forces acting on the body like the Force that happens when we hit an object. However, we usually do not realize the vital forces in the body, such as muscle forces that cause the blood to flow and air to enter the lungs. The structure of human bodies is quite different from that of robots. While robots are controlled by motors or engines which can exert a great amount of torque at the joints regardless of posture, the human body is driven by muscles attached to the bones. Since the forces exertable by the muscles depend on their length and contraction velocity, the human joints have limited ability to create joint torques dependent on posture and motion.

Physicists recognize four fundamental forces. In the order of their relative strength from weakest to strongest they are: gravitational, electrical, weak nuclear, and strong nuclear. Only the gravitational and electrical forces are of importance in our study of the forces affecting the human body. The electrical force is important at the molecular and cellular levels, e.g., affecting the binding together of our bones and controlling the contraction of our muscles. The gravitational force, though very much weaker than the electrical force by a factor of 10^{39} , is important as a result of the relatively large mass of the human body (at least as compared to its constituent parts, the cells).

In this way the muscles characterize human body motion. The configuration space of a body is determined by the ligaments, tendons and passive elements of the muscles. Muscles crossing more than two joints (biarticular muscles) can simultaneously generate torque at a number of joints. For example, the hamstrings can extend the hip joint and flex the knee joint at the same time. For this reason there are dependences among the torques exertable by the joints. It is known that such muscles play important roles in motions such as jumping and gait.¹ As a result, animation of the body becomes unnatural if the dynamics of the muscles is ignored. It is always necessary to check whether the motion of the human body model is actually realizable in dynamic environments by a real human body.

A. Additive Components and Force

A study of motion will involve the introduction of a variety of quantities that are used to describe the physical world. Examples of such quantities include distance, displacement, speed, velocity, acceleration, force, mass, momentum, energy, work, power, etc. All these quantities can be divided into two categories, **vectors** and **scalars**. A vector

quantity is a quantity that is fully described by both magnitude and direction. On the other hand, a scalar quantity is a quantity that is fully described by its magnitude. The emphasis of this unit is to understand some fundamentals about vectors and to apply the fundamentals in order to understand motion and forces that occur in two dimensions. Here we repeat the bit about the vector sum. Vector illustrated dart. Direction of the arrow indicates the direction of the vector, and the length of the arrows is proportional to the vector magnitude. Vector resulting from the addition or subtraction of two or more vectors is called the resultant.

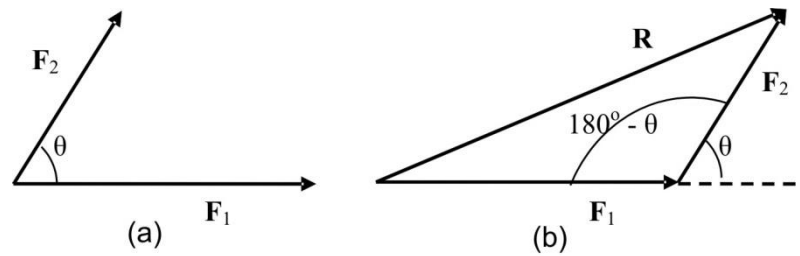

Figure 8.1. Method of the base-to-tip of the vector sum.

Resultant vector magnitude can be searched with the help of trigonometry. In Figure 8.1 (b) we obtain

$$R = \sqrt{F_1^2 + F_2^2 - 2F_1F_2 \cos(180^\circ - \theta)} \quad \dots (8.1)$$

If two Forces are mutually perpendicular ($\theta = 90^\circ$), will be obtained

$$R = \sqrt{F_1^2 + F_2^2 - 2F_1F_2 \cos 90^\circ}$$

or

$$R = \sqrt{F_1^2 + F_2^2} \quad \dots (8.2)$$

Equation (8.2) is the formula of Pythagoras.

Method of the base-to-end vector can be extended to three or more, as shown in Figure 8.2.

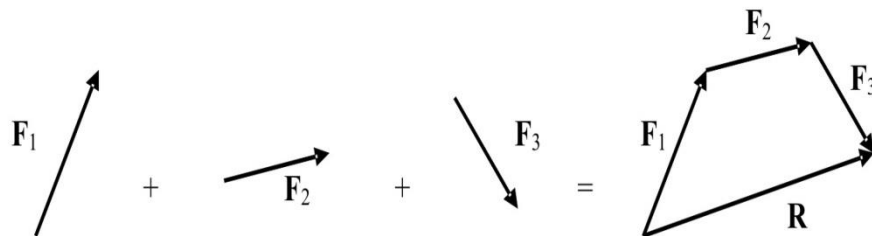

Figure 8.2. Resultant of three vectors.

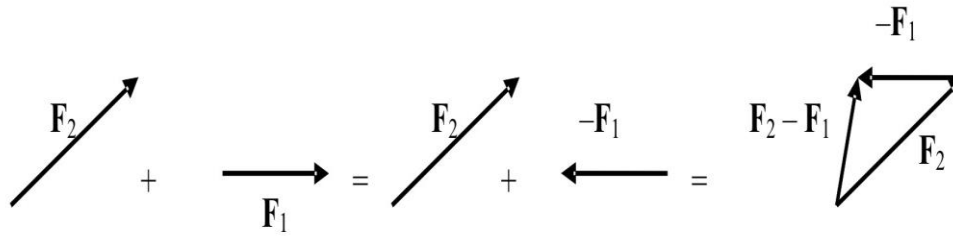

Figure 8.3. Reduction of two vectors F_2-F_1 .

If the vector F is known, then we define the vector of vectors is negative ($-F$) as a vector whose magnitude is equal to the F vector magnitude, but opposite direction. It should be noted that there are no negative magnitude vectors, each vector is a big positive. The negative sign just talking about him. Thus we can find the difference of two vectors, $F_2 - F_1$, which is defined as

$$F_2 - F_1 = F_2 + (-F_1).$$

We can use the methods of the base-to-tip, as shown in Figure 8.3. A vector which lies in a plane can be expressed as the sum of two vectors is referred to as a component or projection of the original vector. The components are usually chosen in a perpendicular direction, for example in the x-y horizontal and vertical directions. The process of searching for the components of a vector is called vector decomposition into its components.

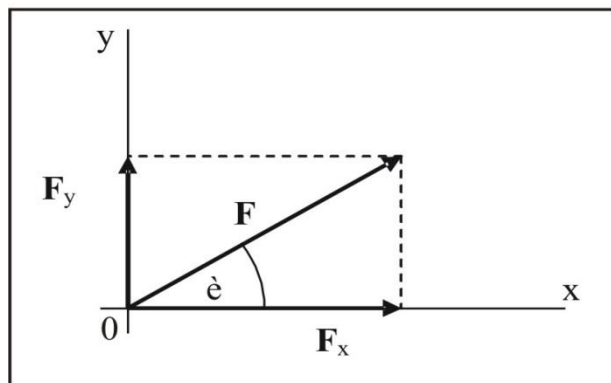

Figure 8.4. Vector components.

In Figure 4.4, the force F is decomposed into two components in the x-direction and y-direction, ie F_x and F_y . Kompoen big-Force component that is

$$F_x = F \cos \theta \quad \dots (8.3a)$$

$$F_y = F \sin \theta \quad \dots (8.3b)$$

This problem can be reversed, which is seeking its direction vector and its components based on the known. According to Pythagoras formula

$$F = \sqrt{F_x^2 + F_y^2} \quad \dots (8.4a)$$

direction

$$\tan \theta = \frac{F_y}{F_x} \quad \dots (8.4b)$$

B. Force Causes Acceleration; Newton Laws of Motion

Newton's laws of motion are three physical laws that together laid the foundation for classical mechanics. They describe the relationship between a body and the forces acting upon it, and its motion in response to said forces. They have been expressed in several different ways over nearly three centuries. Every acceleration (or any change in velocity) caused by the forces acting on an object. Conversely, if an object is not accelerating, the net force acting on it is zero though some force acts on the object.

The idea of cause and effect that seems simple, that force causes acceleration does not occur easily. Sometimes we are tempted to imagine a common symptom as something for no reason and just "the nature of things." For example, questions such as "Why is the water flowing from upstream to downstream?" seems silly. But such questions have serious answer, in this case the force of gravity causes the water to flow from upstream to downstream. Newton (and other scientists) provide answers to basic questions like that. Force can be defined intuitively as the pull or push. If there is only one force acting on an object, then that object will experience acceleration in the same direction as the direction of the force. The strength of this force determines the acceleration of objects. If some force acting on an object, then the acceleration is in the direction of the net force and the acceleration is proportional to the total force.

Newton wrote the relationship between force and motion of objects in a form that can be used to predict and describe the motion of objects. We know him as Newton's three laws of motion.

1. Newton's first law, which is expressed as follows:

When viewed in an inertial reference frame, an object either is at rest or moves at a constant velocity, unless acted upon by an external force

The nature of the object that causes the object to remain silent or maintain motion with constant velocity is called inertia or mass of the object in question. The first law states that if the net force (the vector sum of all forces acting on an object) is zero, then the velocity of the object is constant. Velocity is a vector quantity which expresses both the object's speed and the direction of its motion; therefore, the statement that the object's velocity is constant is a statement that both its speed and the direction of its motion are constant. Inertia and mass are the same thing, but the mass term is much more commonly used. Mass of the object is proportional to the number of atoms or molecules in it, so that the mass of the object does not depend on its location. The

mass of an object will always be the same no matter where the object is, on Earth, in space, or on the Moon. The greater the mass of the object, the more difficult the object is accelerated.

2. Newton's second law, which is expressed as follows:

The vector sum of the forces on an object is equal to the total mass of that object multiplied by the acceleration of the object. In more technical terms, the acceleration of a body is directly proportional to, and in the same direction as, the net force acting on the body, and inversely proportional to its mass

If the outside of the net force given the symbol $F_{l,net}$, the mass of the object given the symbol m , the acceleration of the object a can be written as

$$a = \frac{F_{l,net}}{m} \quad \dots (8.5a)$$

or

$$F_{l,net} = ma \quad \dots (8.5b)$$

3. Newton's third law, which stated as follows:

When one body exerts a force on a second body, the second body simultaneously exerts a force equal in magnitude and opposite in direction to that of the first body.

From a conceptual standpoint, Newton's third law is seen when a person walks: they push against the floor, and the floor pushes against the person. Similarly, the tires of a car push against the road while the road pushes back on the tires—the tires and road simultaneously push against each other. In swimming, a person interacts with the water, pushing the water backward, while the water simultaneously pushes the person forward—both the person and the water push against each other. The reaction forces account for the motion in these examples. These forces depend on friction; a person or car on ice, for example, may be unable to exert the action force to produce the needed reaction force.

The third law states that all forces exist in pairs: if one object A exerts a force F_A on a second object B , then B simultaneously exerts a force F_B on A , and the two forces are equal and opposite: $F_A = -F_B$. The third law means that all forces are *interactions* between different bodies, and thus that there is no such thing as a unidirectional force or a force that acts on only one body. This law is sometimes referred to as the *action-reaction law*, with F_A called the "action" and F_B the "reaction". The action and the reaction are simultaneous, and it does not matter which is called the *action* and which is called *reaction*; both forces are part of a single interaction, and neither force exists without the other (http://en.wikipedia.org/wiki/Newton%27s_laws_of_motion).

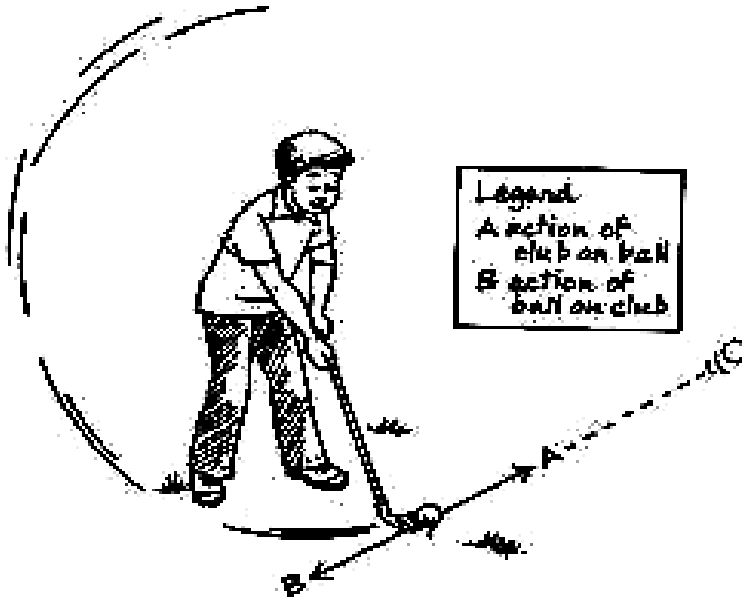

Figure 8,5. The third law states that all forces exist in pairs A and B

C. Weight, Friction, Stress, and Classification of Force

Traditionally, the Forces are classified into groups and given a name based on the source, how the Force passed, or what effect.

1. Weight and gravity

Weight is the force of gravity on an object. Acceleration of gravity, g , for the objects are the same for all objects, provided there are no other forces besides gravity works. In these circumstances the outside net force on an object is the force of gravity, ie the weight of the object. By using Newton's second law and give emblem w for the weight of the object having mass m , we can write

$$w = mg \quad \dots (8.6)$$

Acceleration of gravity for places that are not far from the earth's surface is usually considered equal to 9.8 m/s^2 , and its direction is always downward (toward the center of the Earth). So weight of 1.0, kg object on Earth is

$$W = (1.0 \text{ kg}) (9.8 \text{ m/s}^2) = 9.8 \text{ N.}$$

Weight depends on the location of the object, since the acceleration of gravity varies with the place. For example, the acceleration of gravity on the Moon is approximately only 1.7 m/s^2 , so that the body of mass 1.0 kg weight on the Moon is only 1.7 N, while its weight on Earth is 9.8 N.

The gravitational force on a solid body can be considered to work at a point, called the center of gravity (cg). If the form of symmetrical objects, such as balls, then the center of gravity is located at the geometric center. Not symmetrical objects, such

as humans, will have a center of gravity closer to the solid parts of the body. Closely related concept is the center of mass (AM), which is the point where all the mass of an object can be considered to lie at that point. Center of gravity and center of mass can be calculated accurately from the distribution of mass in an object.

2. Newton's law of general gravity

In addition to Newton's three laws of motion above, Newton also wrote the law known as the law of gravity general. This law states that there are forces of attraction between two masses is proportional to the product of the magnitude of the two masses and inversely proportional to the square of the distance between the center of mass. In equation form this law is written as

$$F = G \frac{mM}{r^2} \quad \dots (8.7)$$

with constant G has a value determined experimentally $N \cdot m^2/kg^2$ 6.67×10^{-11} , m and M are the masses of two objects interact, and r is the distance of the center of mass.

3. The application of the force of gravity in the body

One of the important medical effects of gravity is the formation of varicose veins in the legs as the venous blood travels against the force of gravity on its way to the heart. Yet gravitational force on the skeleton also contributes in some way to healthy bones. When a person becomes “weightless,” such as in an orbiting satellite, he or she loses some bone mineral. This may be a serious problem on very long space journeys. Long-term bed rest is similar in that it removes much of the force of body weight from the bones which can lead to serious bone loss.

a. Blood circulation

Heart is essentially a pump; without the work of the heart blood fluid will be attracted to the hands and feet due to Earth's gravity. Normal heart gave a boost to the blood upwards, towards the head, opposite the force of gravity. Patients with low blood pressure can be helped with foot raised bed so that blood flow to the head, by utilizing the force of gravity.

Fainting can be caused by lack of blood supply to the brain. If we stand too long, the blood collects in the legs due to gravity, which causes us to faint. To help people fainting, tidurkan the person and lift his legs to help the blood flow to the brain. In case of sitting, head hunched forward in between the thighs can push blood to the head.

b. Drainage of fluid

Earth's gravitational force can be used in many medical treatments. Patients with chest discomfort experienced collection of fluid in the lungs. Chest fluid collection can affect the heart and lungs. Therefore, patients feel helped by sitting

upright, which allows gravity to drain the fluid down, providing a larger space for the heart and lungs to function.

c. Astronaut

One of the medical problems in space flight is the effect of weightlessness and the lack of gravity on blood circulation. Terancang normal human body to emlawan gravity so that the heart produces thrust to overcome the force. During the astronauts left the Earth and enters the space nagkasa, blood fluid tends to accumulate in the hands and feet due to gravitational force gets smaller, thus reducing the blood in the brain and cause unconscious. This can be overcome by wearing clothes that contain the pressure of air at pressures that lead to the same forces with gravity, thus helping the return of blood to the head and the heart.

4. Friction and normal force

Friction and the energy loss resulting from friction appear everywhere in our everyday life. Friction limits the efficiency of machines such as electrical generators and automobiles. On the other hand, we make use of friction when our hands grip a rope, when we walk or run, and in devices such as automobile brakes.

Some diseases of the body, such as arthritis, increase the friction in bone joints. Friction plays an important role when a person is walking. A force is transmitted from the foot to the ground as the heel touches the ground

Friction is the force that was used we know that is always against the motion of objects. Friction force generated by the physical contact between the materials. Friction force is proportional to the force that carried an object to another object that is perpendicular to the surface between the two objects, which is called the normal force (ie, perpendicular to the surface). Mathematical expression for the frictional force f is:

$$\begin{aligned} f &= \mu_k N \\ f &\leq \mu_s N \end{aligned} \quad \dots (8.8)$$

with μ_k is the coefficient of kinetic friction, coefficient of static friction is μ_s (μ is the Greek letter mu), and N is the normal force. The coefficient of kinetic friction between the two specified objects are always smaller than the coefficient of static friction between the two objects ($\mu_k < \mu_s$). For example, in a wooden shoe: $\mu_k = 0.7$ and $\mu_s = 0.9$, the bones are lubricated with synovial fluid: $\mu_k = 0.015$ and $\mu_s = 0.016$).

The behavior of the friction force can be observed when we push a heavy box on the floor. When we push the box with a small force, the box does not move; clear that the friction force has emerged and is equal to the force applied. Friction force is the force of static friction work. Then we push the Force increasingly enlarged, until at some point the right box will move. At this time the static friction force reaches its maximum is equal $\mu_s N$. Finally, moving objects and the friction force is the force of kinetic friction work.

Example 8.1

Someone who wears the shoe is running on the wooden floor. (a) Calculate the maximum angle made to the vertical leg forward so that the heel does not slip on the floor. (b) What is the effect of the angle if the floor was wet, which lowers the value of the coefficient of static friction?

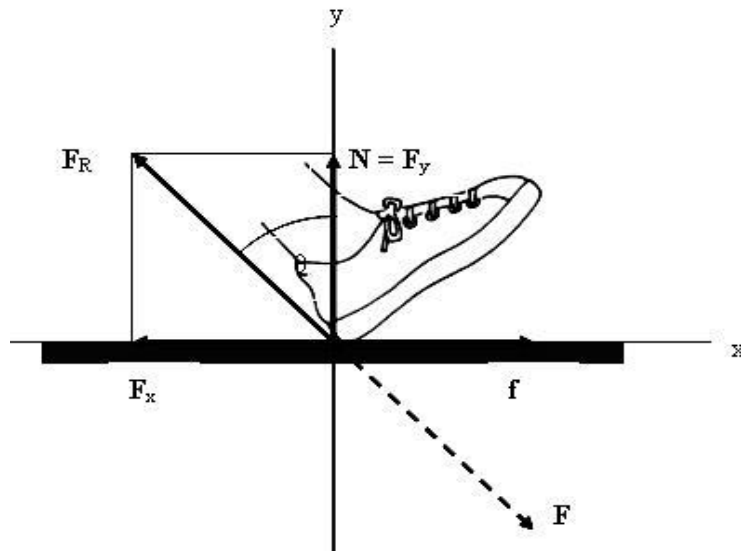

Figure 8.6. If the shoe does not slip, the angle θ must be smaller than a certain critical angle that depends on the coefficient of static friction between the heel and the floor.

Completion

(a) The geometry of the situation is shown in Figure 8.6. Force F is made shoe against the floor, if not derailed, have F_R reaction, which can be decomposed into two components parallel and perpendicular to the floor in a row is:

$$F_x = F \sin \theta \quad F_y = F \cos \theta$$

Condition that the heel does not slip is that large frictional force f must be the same as the components F_x . Because

$$f = \mu_s N = \mu_s F \cos \theta$$

and

$$f = F_x$$

then

$$\mu_s F \cos \theta = F \sin \theta$$

$$\frac{\sin \theta}{\cos \theta} = \mu_s$$

$$\tan \theta = \mu_s$$

Suppose the coefficient of static friction between the shoe and the timber is 0.5, then

$$\tan \theta = 0,5 \text{ or } \theta = 27^\circ$$

So the angle θ must be less than or equal to 27° so that the shoes are not slipping.

- (b) Decrease in μ_s also means a decrease in θ , so that steps should be taken smaller on slippery surfaces. Slipping is a process that occurs suddenly, as when the slip started to occur, the coefficient of kinetic friction smaller will take over, and the friction force will drop sharply. It is therefore difficult to avoid falling when it starts slipping.

5. Application of Friction in Body Force

a. Joint

The bones of the joints are not in direct contact with each other, because the friction force will work, which makes it difficult to move. Lubricating fluid or synovial fluid found in joints to overcome the frictional force. The surface of the bones that have a slippery surface is another factor that reduces friction. Chemical precipitate on the surface of these bones can obstruct the free movement of the joints and the joints such as arthritis can be crippling.

b. Lubrication body

The human body has so many moving parts besides joints, so the need for lubrication system to prevent friction force which reduces the efficiency of movement. For example, the main lubricant is a substance called mucus, which prevents friction between the motion of the lungs and heart. Similarly, the food is lubricated with saliva before swallowing.

Experiencing skin friction between the arms and thighs, and also by the clothing, or the wind. Fortunately, skin glands produce lubricating itself in the form of fluid.

6. Tension

Tension is a force that is transmitted by ropes, cables, chains, and so on, are flexible. Because the carrier medium is a flexible Force, stress can only be a pull and it just worked all mediums. In the muscular system stringy tendons that transmit the forces carried by the muscles of the body to another is called a tendon.

Example 8.2:

A load is hung on the spring balance, as in Figure 4.6. If the mass of the load is 1 kg and the Earth's gravitational acceleration $g = 9.8 \text{ m/s}^2$, what is the voltage on the neck strap?

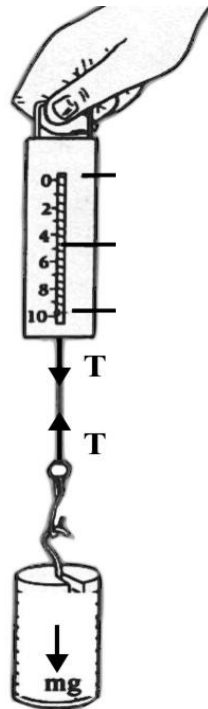

Figure 8.7.

T Force performed by the load balance as a reaction to hang in the balance, causing the balance reads 9.8 N.

Connecting strap Force carried forward by the balance of the load, also the reaction force on the balance sheet (Avison, 1989:74).

Completion

We choose as the system load. Forces acting on the system is voltage T and weight $w = mg$. Burden in a state of not moving, so according to Newton's second law

$$F_{l,net} = T - w = 0$$

so that

$$T = w = mg = (1 \text{ kg})(9,8 \text{ m/s}^2) = 9,8 \text{ N}$$

7. Classification of Forces

Based on its origin, the physicists classify the Forces of the four basic forces. The first basic forces in physics is the force of gravity. Newton's law of gravity to define a common, which states that there are forces of attraction between two objects, weight of our body caused by the force of attraction between the Earth and our bodies. One effect of the gravitational force is the formation of blood vessels in the legs during the blooming vine blood against gravity on its way to the heart.

The second basic Force is the electromagnetic force, which involves tensile force and the repulsive force between static electric charges, and the magnetic forces generated by electric charges in motion (electric current). Our body is basically an electric engine. The forces generated by the muscles caused by a repulsive force or attractive force between electric charges. Controlling the muscle is electric. Each living cell in the body, numbering billions, have the electrical potential difference in the membrane due to the difference in charge inside the cell and outside the cell.

Almost all of the symptoms that can be observed daily can be included in the electromagnetic force. For example, stress caused by electromagnetic forces of molecular and atomic cohesive working in a rope. Friction caused by the electromagnetic interaction between the atoms and molecules of a substance very close contact.

Two other basic Forces involving atomic nuclei. The third basic Force is the strong nuclear force, which works as a " glue " to maintain the core of the repulsive force between the protons in them. The fourth basic Force is the weak nuclear force, which involves decay electrons (beta) of the core.

D. Application of Vector Additive

1. The force carried by muscle

There are three types of muscles in our body. The first type of muscle is the muscle of the heart, namely the muscles that make up the heart wall. The second type is smooth muscle found in the walls of all the hollow organs (except the heart). In general, uncontrolled contraction of smooth muscle. Blood vessels, intestines, and bladder wall is an example that is mostly composed of smooth muscle. The third type is skeletal muscle, the muscle attached to the skeleton. This muscle is controlled by deliberately; contraction of this muscle allows for intentional activities, such as walking, running, throwing, and so on. The three types of muscle have the same characteristics, namely using energy derived from food to perform mechanical work.

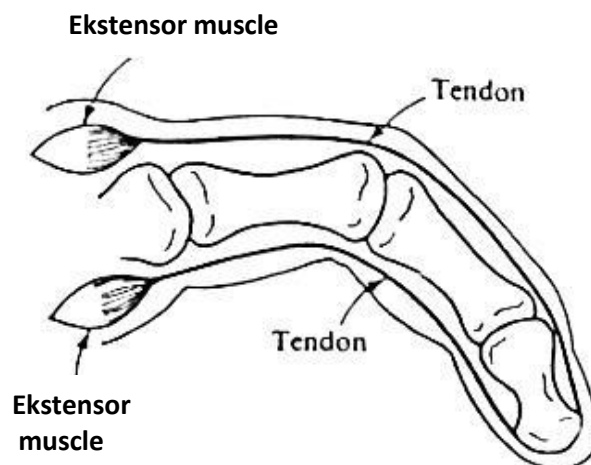

Figure 8.8. Index finger. Note that the tendon deliver Forces performed by muscles through joint that changed the direction of the force (Urone, 1986: 45).

One important application of the force vector is the muscular system. Muscles do work with contracting forces. Many muscles are attached to the bone with two joints between the bones, which allows the movement. The muscles that causes the bones to move closer to each other are called flexors, and muscles that causes the bones to move away from each other are called extensors. One example is the index finger, as in Figure 8.8. The tendon is sometimes convey Force done by a muscle to another point, and even change the direction of the force. There are hundreds of muscles in the body, which allows the forces is done in almost every direction. A number of muscles in the shoulder work simultaneously to produce a net force, as shown in Figure 8.9.

Type of other muscles that can connect the muscles back to him and cause narrowing of the hole when the muscles contract. This kind of muscle, called the sphincter which has multiple functions. For example, the sphincter at the lower end of the esophagus (esophageal) prevent the flow of fluid through the stomach. Sphincter muscles in the eye changing the curvature of the lens of the eye that allows the eye to see clearly objects that are close and far away.

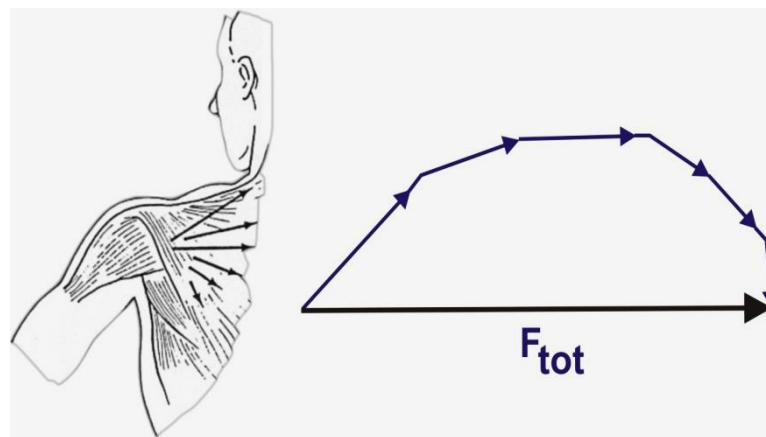

Figure 8.9. Some muscles work simultaneously in shoulder to produce a net force which carried on the arm. (Urone, 1986: 45).

Let 's review one of the other skeletal muscles, the triceps muscle is composed of a thickened muscular stomach and attached to the ends of the bones. At one end, called origio, muscle is directly attached to the bone area that is broad, in this case is the upper arm bone. The other end, called insersio, tapered and becomes shiny white tendon, and attached to the ulna, which is one of the forearm bones. During contractions, Origo part remains motionless and part insersio movement, in this case the elongated arm on the elbow joints. Triceps is said to work as a flexor. The second muscle is needed to dent the joint, the biceps are the forearm flexors; biceps on the forearm flexor called. Biceps and triceps together called antagonistic muscle pair.

2. System pull the pendulum in the medical field

Patients with broken bones and a fractured spine needs to be helped to pull the pendulum Figure 4.9 shows one pull of the pendulum system for patients suffering from hip fractures. This traction system can be analyzed by considering two things. First, the force applied in a direction along the neck strap at a point where the rope was placed on the patient. Secondly, it is the same Force with a weight hanging on a rope. If some force acting on a point, graphic depiction vector method can be used to analyze the system, as shown in Figure 8.10.

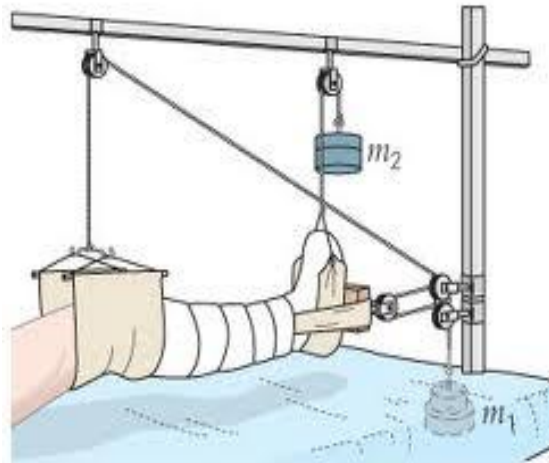

Figure 8.10. Russell traction system pendulum. The forces are summed to obtain the total force that sustains the lower leg and thigh bones have directions along the muscle contraction to compensate. (chegg.com).

E. Statics

1. Statics:Special circumstances of Newton's laws

Statics is the study of objects in equilibrium, such as buildings, bridges, or patients who dibandul. When objects in equilibrium, its acceleration is zero. Often times the object was stationary, but the objects are moving with constant velocity are also in a state of equilibrium; are all included in statics. The objects are silent when in a state of equilibrium. Two conditions must be met for the object to be in equilibrium. First, the net external force acting on the object must be zero so that the acceleration is zero. Second, the object does not rotate. A second requirement is to bring something new, there is likely to make an object rotate though the net external force acting on it is zero.

Figure 8.10 shows two situations in which the two Forces are the same magnitude and opposite direction is given to an object that is stationary on the floor surface without friction. In both situations the outside net force is zero, but if the object is rotating forces do not work directly opposite each other. It is clear that the point of the work force is critical to determine whether the object is rotating or not. In

some situations we want to produce a rotation rather than prevent it, such as when opening doors or moving the arm.

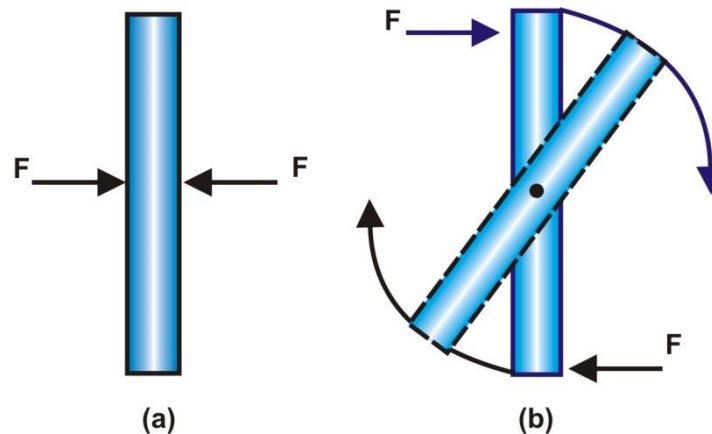

Figure 8.11. Please note the points where the forces working in addition to magnitude and direction of the forces. Two Forces are the same magnitude and opposite direction directly given to objects resting on a frictionless surface. Equilibrium is achieved, so that the object remains stationary. If two same Force it was given at different points, object was rotated and the equilibrium is not reached.

2. Torque or moment of force

Effectiveness of the force to produce rotation is called torque or moment of force. As shown in Figure 8.11, three factors are involved is substantial force, direction Force, and point Force work. Let us consider each of these factors in a row. It is clear that the greater the force the more effective the Force that causes the door to rotate on hinges penggantungnya. Direction of the force is also important.

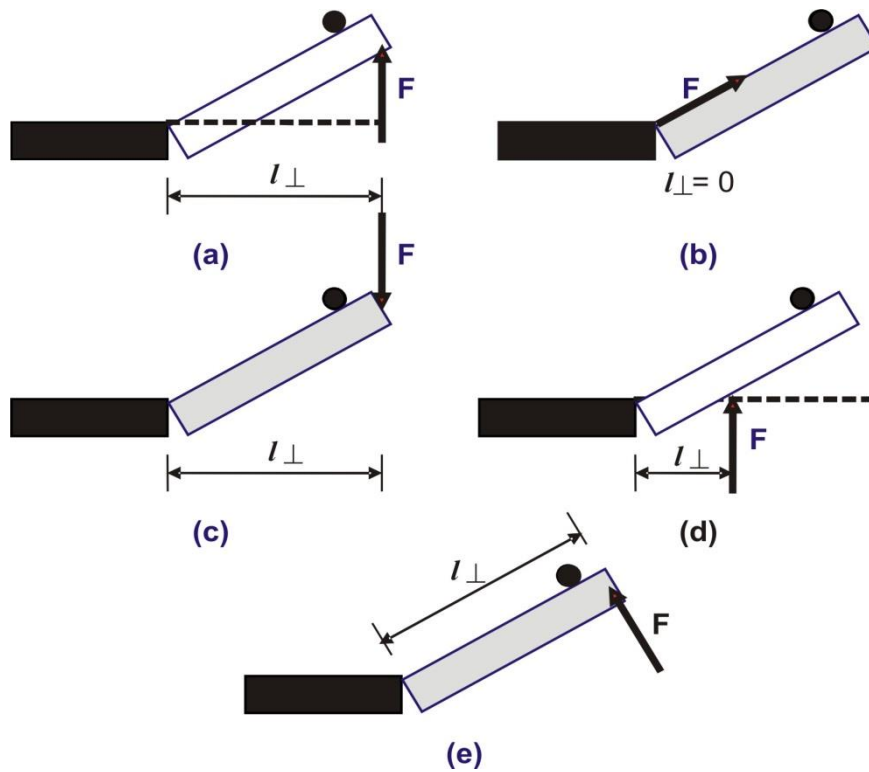

Figure 8.12. Torque generated by the forces acting on the door is viewed from above. (a) The torque counter clockwise direction causes the door to rotate counter clockwise. (b) the torque is equal to zero, so that gravity does not produce rotation at the door. (c) clockwise torque equal and opposite in direction (a). Torque is smaller because the force is given at a point closer to the hinge mounting. (e) lever arm (or moment arm) l_{\perp} equal to the distance from the axis point (hinge hanger) to the point of the work force when force is perpendicular to the door.

If the offensive Force door, as in Figure 8.12 (b), there will be no rotation; we just pull or push the door on the hinges the hunger (torque equal to zero). If the direction of the force is reversed, as in Figure 8.12 (c), the door will rotate in opposite directions: clockwise when viewed from above. The third factor is the point of the work force. Imagine what happens if you push the door hanger is too close to the hinge, as in Figure 8.12 (d); usually can open the door difficult. The further the work force to the axis (hinge hanger), the more effective Force that produces rotation.

Formally defined in terms of the torque equation, which takes into account the three factors, as

$$\tau = l_{\perp} F \quad \dots (8.9)$$

with τ (Greek letter tau) is the torque and l_{\perp} is the lever arm or moment arm perpendicular.

The simplest case occurs if the force perpendicular to the door; l_{\perp} equal to the distance from the axis to the point where the work force, as in Figure 8.12 (e). In other

cases, $l \perp$ determined graphically by drawing a line from a point on the axis perpendicular to the direction of force and then measuring (or calculating) the distance. Two of the three factors (direction of the force and the point where the work force) are incorporated in the $l \perp$. It should be noted that the torque is a vector quantity that has magnitude and direction given. The direction is determined by the rotation of the axis point, whether clockwise or counter clockwise.

Now we can state two conditions of equilibrium in the form of mathematical equations. Acceleration equal to zero means that the net external force must be equal to zero. Non-rotating means that the net torque must be zero or the number of clockwise torque τ_{sj} , the net shall be equal to the amount of torque that is opposite to the clockwise direction τ_{bj} , net. Thus, an object is in equilibrium if it satisfies the following equilibrium condition.

$$F_{l,\text{net}} = 0 \quad \dots (8.10a)$$

$$\tau_{sj,\text{net}} - \tau_{bj,\text{net}} = 0 \quad \text{or} \quad \tau_{sj,\text{net}} = \tau_{bj,\text{net}} \quad \dots (8.10b)$$

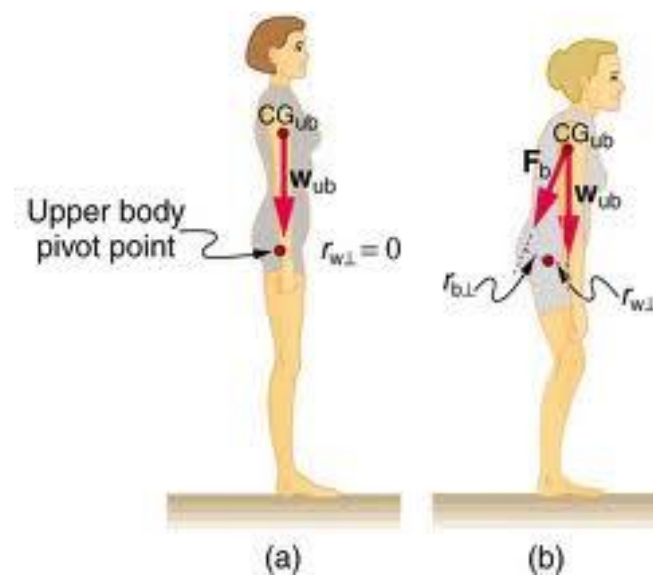

Figure 8.13. (a) A person who is standing upright put the center of gravity of the upper body directly over the axis of the lower back. There is no torque is generated so back muscles do not have to do the torque to maintain equilibrium. Equivalent mechanical system depicted on the right. (b) A person who is bent allowing the upper body burden creates torque that must be balanced by the torque created by the muscles of the back. This can result in muscle strain incredible if prolonged. Note that F_b is greater in the mechanical system equivalent to the right (cnx.org).

We know that poor posture can result in back strain. Figure 8.13 shows why this is the case. When a person stands upright, as in Figure 8.13 (a), upper body weight directly over the foot and a small force carried by the back muscles and leg muscles. Most of the weight is supported by the framework of the system rather than by working muscles. If someone leaned forward, as in Figure 8.13 (b), then the center of gravity of the upper body is no longer directly above the axis. Now back muscles have to do a torque around the axis at the base of the spine to resist the torque caused by the weight of the upper body. Continuous effort by the back muscles produce back strain. One of the most common complaints during pregnancy is back pain as a mother should hold the weight of the baby in the womb with the back muscles. This can partly be alleviated with the correct posture.

Proverb says, 'Lift with your legs, not your back.' Reasoning is the same as the correct posture. As shown in Figure 8.14 (a), when raised with excessive bending, back muscles must provide sufficient torque to lift weights and upper body. If someone picks up the leg, as shown in Figure 8.14 (b), the torque is given by the extensor muscles of the thigh. Thigh muscles do not have the mechanical advantage is greater than the back muscles (l_{\perp} is small for both systems), but the leg muscles are larger and knee joints are better able to master the forces involved than the spine joints bottom.

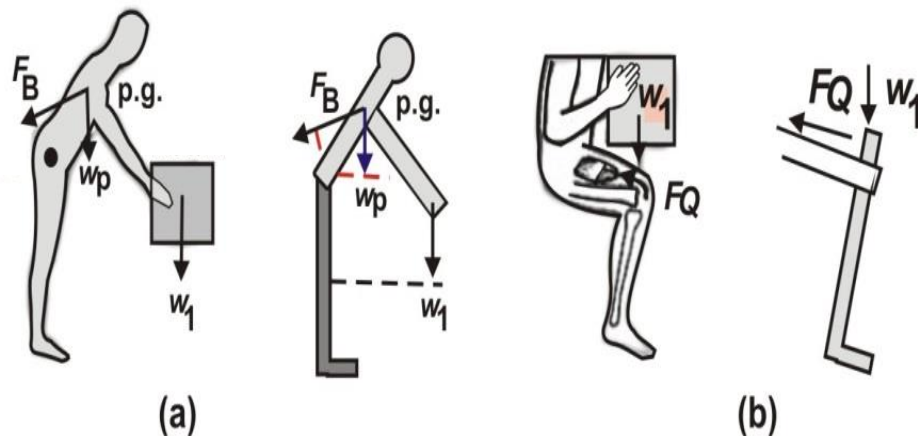

Figure 8.14. (a) If a person is raised with his back, the forces must be created by a very large back muscles (erector spinae) and held by the joints of the lower spine. (b) When a person lifting the leg, thigh muscles (kudrisep) conduct large forces to be detained by the knee joint. Both are better able to withstand these forces rather than the muscles and joints in the spine. Equivalent mechanical system depicted on the right (Urone, 1986: 53).

F. Lever

Lever or lever is a rigid rod can rotate freely around a point called the fulcrum. Lever is used to lift loads in a profitable way and to move the motion of a depressing point to another.

Many systems of the body muscles and bones work as levers. Levers are grouped into three categories system, as shown in Figure 8.14, namely:

1. The first class, which has the axis or fulcrum between the load and power.
2. The second class, which has the load between power and axis or fulcrum.
3. The third class, which has the power between the load and the axis or fulcrum.

The third class lever most widely in the body, then the second class, and first class at least.

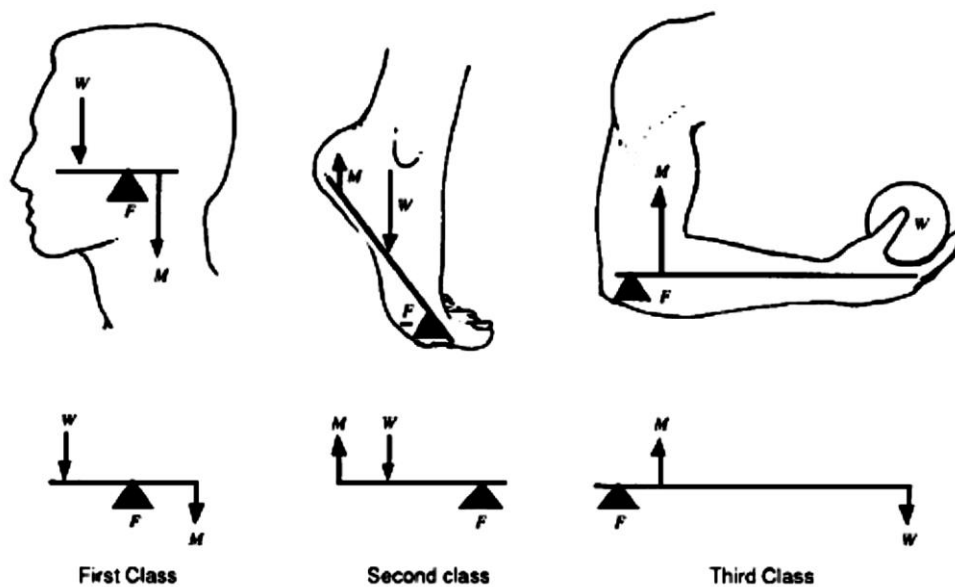

Figure 8.15. Three classes of lever and each sample chart lever body W is the load and F is the force carried out, also called power (Cameron, 1978:17).

Under the equilibrium condition, for three types of lever force F required to offset the amount of a weight w can be calculated as follows.

$$Fl_F = wl_w$$

or

$$F = \frac{wl_w}{l_F} \quad \dots (8.11)$$

lever mechanical advantage is defined as

$$KM = \frac{w}{F} = \frac{l_F}{l_w} \quad \dots (8.12)$$

G. Elbow

Two of the most important muscles that results in elbow motion is biceps and triceps (Figure 8.16) triceps contraction causes the elbows open, while the contraction of the biceps causes the elbow to close. We only pay attention to the work of two muscles. This is a simplification, because a lot of other muscles also play a role in elbow motion. Some of these muscles stabilize the shoulder joint during elbow motion, and other muscles to stabilize the elbow itself.

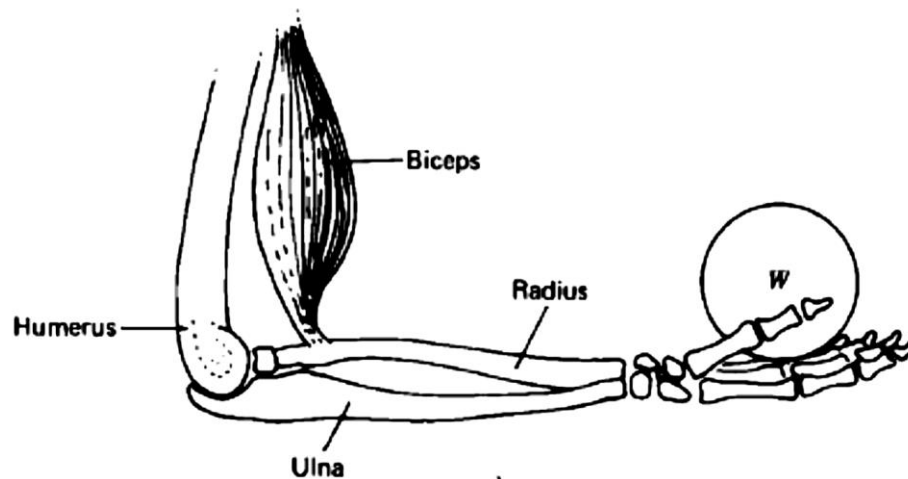

Figure 8.16. Elbow

Example 8.4:

- Calculate the force carried by the biceps and forearms to hold the book as shown in Figure 8.16.
- Compare the force carried by the biceps muscle to the weight of the forearm and the book.

Completion::

- The best way to resolve this problem is to make the forearm as the system need to be considered. There are four external forces acting on the forearm: a heavy arm, heavy wt books, which do biceps muscle force F_B , and Force carried by the upper arm bone F_H at the point of the elbow. Simplification can be done by taking a point on the axis of the elbow joint. Terms equilibrium both sufficient for resolving this problem. Simplification is done by taking a point on the axis of the elbow joint. F_H carried out the torque force is zero because the work force at the point of the axis, so that $l_{\perp} = 0$ for this Force. The values of l_{\perp} other easily determined because the forearm is horizontal. Weight forearm and heavy books w_a wt generate torque in a clockwise direction, while the F_B Force performed by the biceps produces torque in the opposite direction to clockwise.

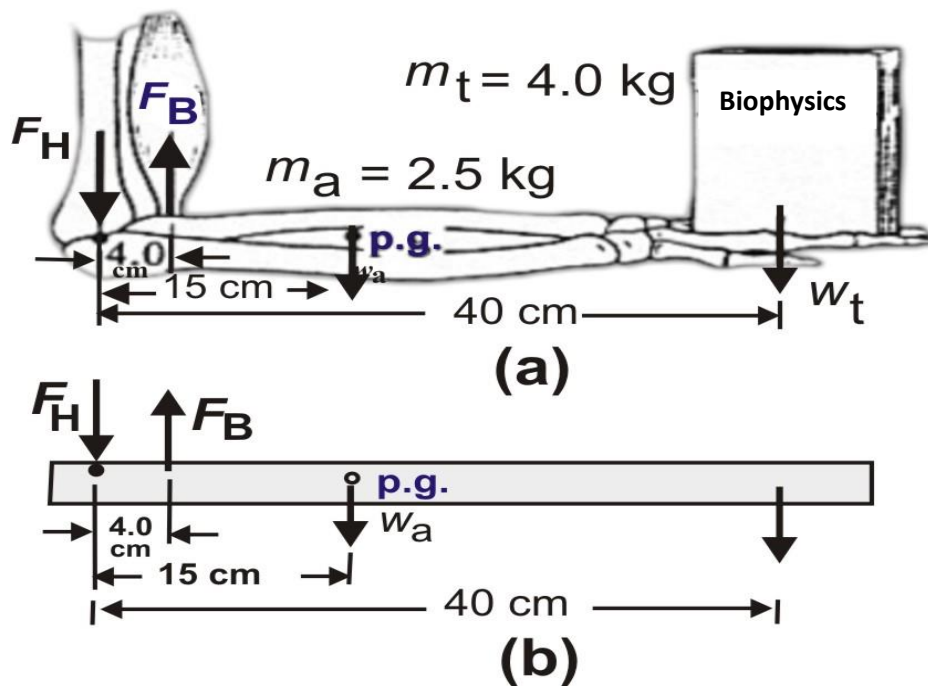

Figure 8.17. Forearm as Example 8.4 holds books and charts to facilitate the depiction of various Forces from the axis point. Weight forearm and produce books clockwise torque, and biceps Force produces opposite torque clockwise, but the Force of the upper arm bone produces no torque because it works directly on the axis point (Urone, 1986: 51).

By applying the equilibrium condition, we obtain

$$(15 \text{ cm})(w_a) + (40 \text{ cm})(w_t) = (4,0 \text{ cm})F_B$$

$$F_B = \frac{(15 \text{ cm})(m_a)(g) + (40 \text{ cm})(m_t)(g)}{4,0 \text{ cm}}$$

$$F_B = \frac{(15 \text{ cm})(2,5 \text{ kg})(9,8 \text{ m/s}^2) + (40 \text{ cm})(4,0 \text{ kg})(9,8 \text{ m/s}^2)}{4,0 \text{ cm}}$$

$$F_B = 483,9 \text{ N}$$

(b) Force combined between the forearm and the load is:

$$w = w_a + w_t$$

$$w = m_a g + m_t g$$

$$w = (2,5 \text{ kg})(9,8 \text{ m/s}^2) + (4,0 \text{ kg})(9,8 \text{ m/s}^2)$$

$$w = 24,5 \text{ N} + 39,2 \text{ N}$$

$$w = 63,7 \text{ N}.$$

Why should perform biceps muscle force 483.9 N to hold the weight of only 63.7 N? This happens because the biceps muscle forces on the arm at a point close to

the elbow, which resulted in a much less effective than force-generating rotational force acting at a distance farther from the elbow, the forearm and the heavy weight of books. To compensate, the biceps must perform a greater force than the force required if located at a distance farther from the elbow. The biceps muscle is said to be in mechanical losses, as well as most of the muscles in the body.

H. Hips

Figure 8.19 shows the hip joint and a simplified depiction of the lever. Existing measures only as examples, since the size for each person will vary. Hip is stabilized by a group of muscles in the joints, which is depicted in Figure 8.17 (b) as a single resultant force F_R . If a person stands upright, the force angle of approximately 71° to the horizontal. Force w_L describe the combined weight of the thighs, legs, and feet. Typically, this is the combined weight of 0,185 w of total body weight ($w_k = 0.185 w$). Weight w_k considered working vertically down the middle between the soles of the feet and groin.

Now we will calculate the muscle force F_m and force F_R at the hip joint when a person is standing on one leg as he walked slowly, as shown in Figure 8.17. W Force that was working on the bottom of the lever is the ground reaction force on the foot. W This Force is a Force that sustain body weight.

Based on the condition of force equilibrium in the x and y directions and torque we obtain

$$F_m \cos 71^\circ - F_R \cos \theta = 0 \quad (\text{x components of force} = 0) \quad \dots (8.13)$$

$$F_m \sin 71^\circ + w - w_k - F_R \sin \theta = 0 \quad (\text{y components of the force} = 0) \quad \dots(8.14)$$

$$(F_R \sin \theta)(7 \text{ cm}) + w_k(10 \text{ cm}) - w(18 \text{ cm}) = 0 \quad (\text{torque about point A} = 0) \quad \dots(8.15)$$

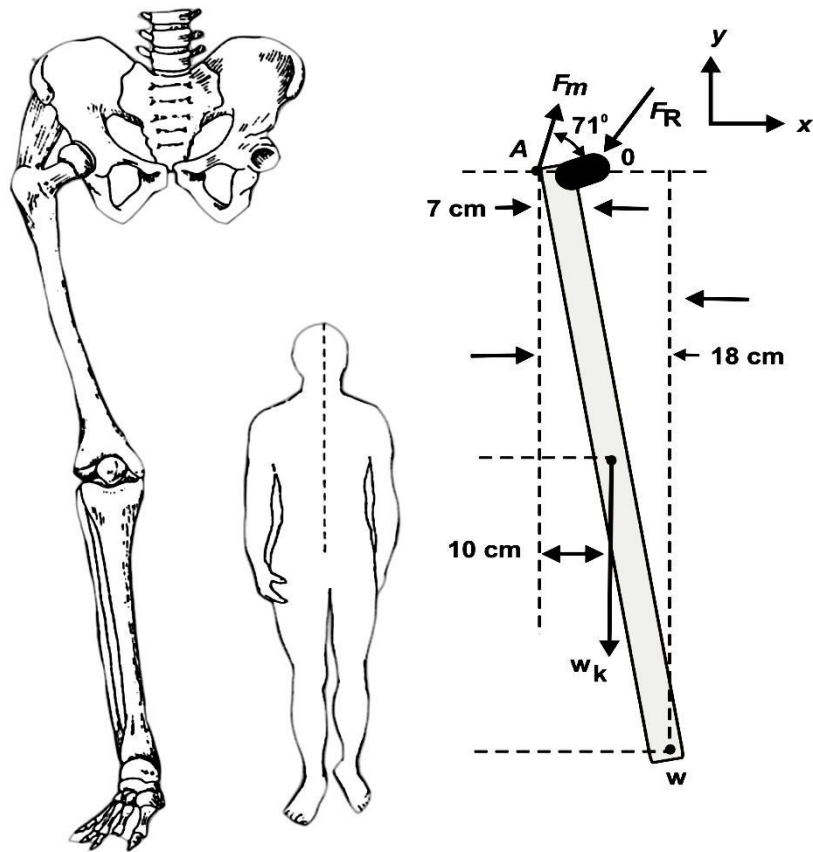

Figure 8.18. (a) Hips. (b) The description of levers (Davidovits, 2001: 16).

Because $w_k = 0.185 w$, from Equation (8.15), we obtain

$$F_R \sin \theta = 2,31w$$

Using the results in Equation (8.14), we obtain

$$F_m = \frac{1,50w}{\sin 71^\circ} = 1,59w$$

From equation (8.13), we obtain

$$F_R \cos \theta = 1,59w \cos 71^\circ = 0,52w$$

Therefore

$$\frac{F_R \sin \theta}{F_R \cos \theta} = \frac{2,31w}{0,52w}$$

$$\tan \theta = 4,44$$

$$\theta = \tan^{-1} 4,44 = 77,3^\circ$$

and

$$F_R = 2,37w \quad \dots (8:16)$$

So the force on the hip joint is 2.37 times the weight of people.

I. Back

When the body is bent forward, the spine, especially in the lumbar vertebra rotates (hip bone) fifth, as shown in Figure 8.18. We will pay attention to the forces involved when the body is bent at an angle of 60° to the vertical (or 30° to the horizontal) with arms hanging freely. Equivalent lever models pictured on the right. Axis point A is the fifth lumbar vertebra. Lever arm AB describe spine. W_3 body weight uniformly distributed along the spine; influence can be described at point E in the middle. Weight w_1 depicted with the head at point B at the end of the lever arm. The arms depicted with w_2 at point D is approximately two-thirds of the spine upwards. Spinal muscular enforcer (erector spinal muscle), is shown as attached to the D-C connection point D, maintain your spine. The angle between the spine and this muscle is approximately 12° .

If the weight is w , then $w_1 = 0.07 w$, $w_2 = 0.12 w$, and $w_3 = 0.46 w$. Suppose the length of the spine $AB = 72$ cm, then $AE = 36$ cm, and $AD = 48$ cm. Then we apply the second condition of equilibrium with given that the moment arm is the perpendicular distance of the force. The amount of torque to the axis of A is zero, so we obtain

$$\begin{aligned}
 &(0,48 \text{ m})(\sin 12^\circ)(F_m) - (0,72 \text{ m})(\cos 30^\circ)(w_1) - \\
 &(0,48 \text{ m})(\cos 30^\circ)(w_2) - (0,36 \text{ m})(\cos 30^\circ)(w_3) = 0 \\
 &(0,48 \text{ m})(0,2079)(F_m) - (0,72 \text{ m})(0,8660)(w_1) - \\
 &(0,48 \text{ m})(0,8660)(w_2) - (0,36 \text{ m})(0,8660)(w_3) = 0 \\
 &(0,099792 \text{ m})(F_m) - (0,62352 \text{ m})(0,07w) - \\
 &(0,41568 \text{ m})(0,12w) - (0,31176 \text{ m})(0,46w) = 0 \\
 &(0,099792 \text{ m})(F_m) - (0,0436464w) - \\
 &(0,0498816w) - (0,1434096w) = 0 \\
 &(0,099792 \text{ m})(F_m) = 0,2369376 \\
 &F_m = 2,37w.
 \end{aligned}$$

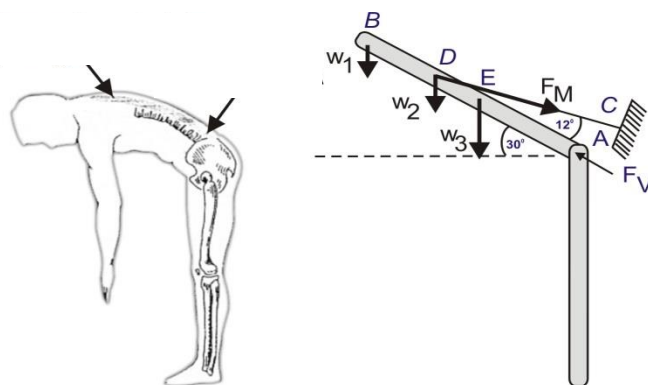

Figure 8.19. Backs bent and depictions lever. (Davidovits, 2001: 19).

We can calculate F_v through its components in the x and y directions, using the first equilibrium condition. Keep in mind large angles ($30^\circ - 12^\circ = 18^\circ$). The number of forces in the y direction is zero, so we obtain

$$F_{vy} - F_M \sin 18^\circ - w_1 - w_2 - w_3 = 0$$

$$F_{vy} - 2,37w(0,3090) - 0,07w - 0,12w - 0,46w = 0$$

$$F_{vy} = 1,38w$$

The number of forces in the x direction is zero, so we obtain

$$F_{vx} - F_M \cos 18^\circ = 0$$

$$F_{vx} - 2,37w(0,9511) = 0$$

$$F_{vx} = 2,25w$$

$$F_v = \sqrt{F_{vx}^2 + F_{vy}^2} = \sqrt{(1,38w)^2 + (2,25w)^2}$$

$$F_v = \sqrt{1,9044w^2 + 5,0625w^2} = \sqrt{6,9669w^2} = 2,6w \quad \dots (8:17)$$

So the forces acting on the fifth lumbar vertebra is 2.6 times weight. The direction of the horizontal force can be calculated as follows

$$\tan \theta = \frac{F_{vy}}{F_{vx}} = \frac{1,38w}{2,25w} = 0,6133$$

$$\theta = 31,5^\circ$$

EXERCISE

To improve your understanding of the material above, do the exercises below!

- Two muscles on the back foot pulling up the Achilles tendon, as shown in Figure 8.20. These muscles are called the medial head and lateral head of the gastrocnemius muscle. Calculate the total force on a large Achilles tendon.

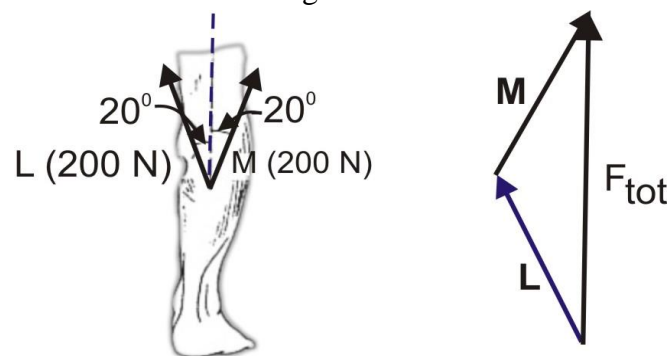

Figure 8.20. The forces that pull up the Achilles tendon. (Urone, 1986: 40).

- 2) thigh muscles (quadriceps) did force 1200 N, which is forwarded by the tendon of the kneecap (patella) at an angle as shown in Figure 8.21. What is the magnitude and direction of the force carried by the kneecap on the thigh bone (femur)?

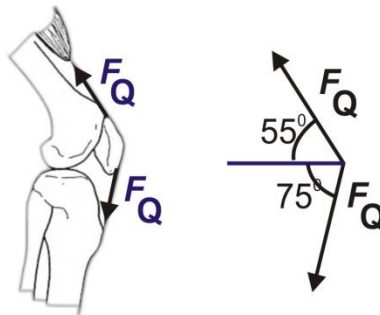

Figure 8.21. The force carried by the quadriceps muscle (Urone, 1986: 40).

- 3) If the acceleration of gravity is $g = 9.8 \text{ m/s}^2$, calculate the force exerted by each pull of the pendulum as shown in Figure 8.22.

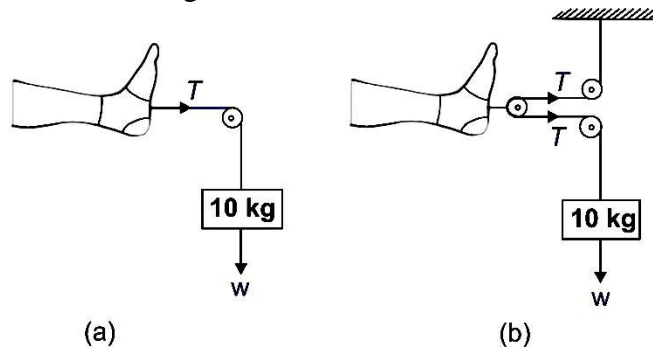

Figure 8.22. System pull the pendulum at the foot of a patient. (Urone, 1986: 61).

- 4) Calculate the force F_y in Figure 8.19 if the person concerned holds a weight of $0.13w$.
 5) A muscle in the jaw called the masseter muscle attaches relatively far from the joints. Therefore, large forces can be carried out by the back teeth. How large a force F is done by the molar teeth on hard candy in Figure 8.23?

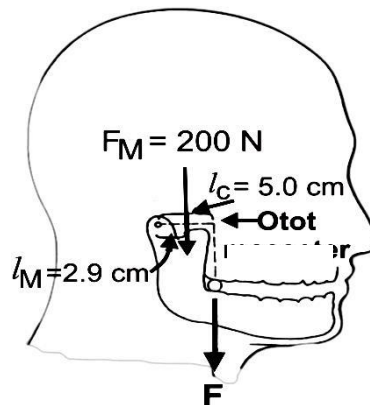

Figure 8.23. The force exerted by the molar teeth in confectionery (Urone, 1986: 63).

Instructions to Answer Exercise

If you have difficulty in completing these exercises, consult the instructions for the completion of each of the following questions.

- 1) Use Equation (8.1) of the vector sum.
- 2) Describe each force in the horizontal and vertical directions. Look for large components. Add up the individual components, then calculate the total force. Use Equation (4.3) and Equation (4.4).
- 3) Look for a heavy pendulum. Voltage equal to the weight of the pendulum rope. Force that made the pull of the pendulum to the right by:(a) the weight of the pendulum and (b) two times the weight of the pendulum.
- 4) Follow the description of the calculation in the back and add Force w 0.13 load at point D.
- 5) Use the second condition of equilibrium of the torque about an axis.

RESUME

Vector resulting from the addition or subtraction of two or more vectors is called the resultant. Resultant vector magnitude can be searched with the help of trigonometry. The resultant R of the two vectors F_1 and F_2 which makes an angle θ is

$$R = \sqrt{F_1^2 + F_2^2 - 2F_1F_2 \cos(180^\circ - \theta)}$$

The force F can be decomposed into two mutually perpendicular components in the x-direction and y-direction, ie F_x and F_y . Major components of the force is

$$F_x = F \cos \theta$$

$$F_y = F \sin \theta$$

Instead, we can look for a large vector F by the components F_x and F_y are known is by using Pythagoras formula

$$F = \sqrt{F_x^2 + F_y^2}$$

and direction

$$\tan \theta = \frac{F_y}{F_x}$$

Newton wrote the relationship between force and motion of objects to describe the motion of objects, known as Newton's three laws of motion. Newton's first law states that an object will remain stationary or moving in a straight line at constant speed if no outside force acting on it.

Newton's second law states that the acceleration produced by the forces acting on an object is directly proportional to the net and a large external force is inversely proportional to the mass of the object, and the direction of acceleration is the same as the direction of the net external force. If the outside of the net force given the symbol $F_{l,net}$, the mass of the object given the symbol m , the acceleration of the object a can be written as

$$a = \frac{F_{l,net}}{m} \quad \text{or} \quad F_{l,net} = ma$$

Newton's third law states that when a body of forces on the two objects, both objects will perform in the Force of the first objects of the same magnitude and opposite direction. This law is often called the law of action-reaction. Mathematical expression for the frictional force f is:

$$f = \mu_k N$$

$$f \leq \mu_s N$$

with μ_k is the coefficient of kinetic friction, coefficient of static friction is μ_s and N is the normal force. The coefficient of kinetic friction between the two specified objects are always smaller than the coefficient of static friction between the two objects ($\mu_k < \mu_s$).

Based on its origin, the physicists classify the Forces of the four basic forces, namely gravity, electromagnetic force, strong nuclear force and the weak nuclear force. Examples summation is performed muscle force and the pull of the pendulum system in the medical field. There are three types of muscles in our body, the heart muscle, smooth muscle, and skeletal muscle.

Torque is defined in equation form as $\tau = l \perp F$, τ is the torque and $l \perp$ is the lever arm or moment arm perpendicular. Lever or lever is a rigid rod can rotate freely around a point called the fulcrum. Many systems of the body muscles and bones work as levers. Levers of the system are grouped into three categories, namely:

1. First Group, which has the axis or fulcrum between the load and power.
2. The second class, which has the load between power and axis or fulcrum.
3. The third class, which has the power between the load and the axis or fulcrum.

There are two conditions of equilibrium, which can be written that if the external force is $F_{l,net}$, clockwise torque $\tau_{sj,net}$, and the net torque opposing the clockwise direction is $\tau_{bj,net}$, the equilibrium condition is written as

$$F_{l,net} = 0$$

$$\tau_{sj,net} - \tau_{bj,net} = 0 \quad \text{or} \quad \tau_{sj,net} = \tau_{bj,net}$$

Elbows, hips, and spine are examples of the application of equilibrium in the body.

CHAPTER 9

PRESSURE AND FLUID FLOW IN THE BODY

Fluid dynamics is involved in several different physical processes in development. A first is that fluid pressure is used to enlarge tubes and maintain them at a given size. Examples are the lung, heart, kidneys, etc.; we may note the related use of fluid pumped into developing structures to unroll and stiffen them in plants, turgor pressure, insects and cnidarians, the hydrostatic skeleton, and elsewhere. Even the liquid and the gas itself is a part of life. Therefore, the physics of liquids and gases is the basis of life itself.

If we look at how fluid flow is induced in these processes, we find that in many instances motile cilia are employed to drive fluid motion. This is the case, for example, in the developing kidney, ear, and brain. However, cilia are not the only mechanism for moving fluids; the heart is the obvious example of a different approach: it initially uses peristalsis and subsequently develops into a chambered valved pump. The actomyosin system is another ubiquitous mechanism for the generation of fluid motion within the cell. The physical mechanism of cyclosis based on actomyosin is varied. In *Chara* what moves the fluid is drag produced by particles, small vesicles, transported by actin tracks, while in *C. elegans*, it seems to be the result of the contraction of the cellular cortex. Liquids and gases have many characteristics in common. However, liquids and gases can be distinguished in several respects. For example, the liquid is almost incompressible, while the gas can be compressed easily. Liquids tend to have a greater density than the gas. Gas phase of a substance usually has a temperature higher than the melting phase. Therefore, the gas molecules are able to burst free from one place to another. Gas is able to escape from an open container, while the liquid cannot. Liquids and gases are collectively known as the fluid which means having the ability to flow.

Osmotic pressure is a further general physical mechanism for setting fluids in motion, to which recent work on the aquaporin gene family which encodes proteins that function as membrane channels, the channels through which liquids are secreted and adsorbed by cells provides a useful counterpoint.

A. Pressure

Pressure is the most important concept in the fluid. Pressure is defined as the force exerted per unit area, which can be written as

$$P = \frac{F}{A} \quad \dots (9.1)$$

with F is the applied force, A is the area where the work force, and P is the pressure. The generally accepted definition of pressure, in solids, liquids, and gases. Pressure measurement is an event that is frequently encountered in everyday life. Tires should be inflated to the appropriate pressure, blood pressure should be within the normal range, and the pressure inside the eye is too large (glaucoma) can cause blindness. Pressure in the International System of Units is the pascal (Pa) or newtons per square meter (N/m^2), $1 \text{ N/m}^2 = 1 \text{ Pa}$.

Unfortunately, there are many units of pressure that can not be avoided. Table 9.1 shows a list of some common unit of pressure. The air pressure at certain places slightly varies with the weather. At sea level atmospheric pressure average is $1.013 \times 10^5 \text{ N/m}^2$ (or 14.7 lb/in^2). So, $1 \text{ atm} = 1.013 \times 10^5 \text{ N/m}^2 = 101.3 \text{ kPa}$. This value is used to define the units of pressure are well known, namely the atmosphere (abbreviated atm). In meteorology and weather mapping is often used unit bar, which is defined as $1.0 \text{ bar} = 1.000 \times 10^5 \text{ N/m}^2 = 100 \text{ kPa} = 0.10 \text{ MPa}$.

Table 9.1. The conversion factor for various pressure

Conversion to N/m^2	Conversion of atm
$1,0 \text{ atm} = 1,013 \times 10^5 \text{ N/m}^2$	$1,0 \text{ atm} = 1,013 \text{ N/m}^2$
$1,0 \text{ dyne/cm}^2 = 0,1 \text{ N/m}^2$	$1,0 \text{ atm} = 1,013 \times 10^6 \text{ dyne/cm}^2$
$1,0 \text{ kg/cm}^2 = 9,8 \times 10^5 \text{ N/m}^2$	$1,0 \text{ atm} = 1,03 \text{ kg/cm}^2$
$1,0 \text{ lb/in.}^2 = 6,90 \times 10^3 \text{ N/m}^2$	$1,0 \text{ atm} = 14,7 \text{ lb/in.}^2$
$1,0 \text{ mm Hg} = 133 \text{ N/m}^2$	$1,0 \text{ atm} = 760 \text{ mm Hg}$
$1,0 \text{ cm Hg} = 1,33 \times 10^3 \text{ N/m}^2$	$1,0 \text{ atm} = 76,0 \text{ cm Hg}$
$1,0 \text{ cm air} = 98,1 \text{ N/m}^2$	$1,0 \text{ atm} = 1,03 \times 10^3 \text{ cm air}$
$1,0 \text{ bar} = 1,000 \times 10^5 \text{ N/m}^2$	$1,0 \text{ atm} = 1,013 \text{ bar}$

Note: $1 \text{ Pa} = 1 \text{ N/m}^2$; $1 \text{ Torr} = 1 \text{ mm Hg}$.

Pressure is often as important as the style that caused him. If someone stabs you with a finger, you will be able to feel it. But, if you stab a nurse with a syringe that uses the same style, the needles tear your skin. Given the same style in a smaller area would result in greater pressure and have a much different effect.

B. Pascal Laws

A pioneer in fluid physics is Blaise Pascal (1623-1662), French philosopher and scientist. Pascal discovered the principle which states that the pressure exerted on a confined fluid will be transmitted equally to all parts of the fluid. This means that the pressure is given it will be added to the existing pressure in the fluid. One form of Pascal's principle is that the total pressure at the bottom of the pool is the amount of pressure caused by the weight of the water plus the atmospheric pressure. According to Pascal's principle in atmospheric pressure passed to the bottom of the pool. Because water is not rigid, the water can not support the weight of the atmosphere without forward it to all parts of the pond.

Pressure due to the weight of Earth's atmosphere performed on all objects including the human body. Our body can withstand the pressure is so great, because living cells maintain internal pressure approximately equal to the external pressure, slightly larger than the atmospheric pressure. Car tires, because of her strength, can sustain the pressure is much greater than the external atmospheric pressure.

Most of the symptoms that occur in the Earth's atmospheric pressure besides involving other pressures involved. The influence of atmospheric pressure often mutually exclusive or can be ignored, and rather tiring always include adding atmospheric pressure

to obtain the total pressure measurement therefore pressure (gauge pressure) is defined as the pressure above or below atmospheric pressure. The total pressure or absolute pressure measurement P is pressure plus atmospheric pressure P_{atm} P_g ,

$$P_{tot} = P_{gauge} + P_{atm} \quad \dots (9.2)$$

An easy way to remember this equation is to remember that the pressure measurements are read zero when a tire was in a state of collapse, despite a flat tire with large holes clearly contain air at atmospheric pressure. It has a flat tire pressure measurement and zero total or absolute pressure of 1 atm.

It should be noted that given pressure, not force, transmitted evenly to all parts of the fluid. This fact is very important to make the pressure in the fluid. Forwarded by a fluid style, but that style can be made smaller or larger by the fluid depends on the environment.

C. Weight For Fluid Pressure

The force of gravity causes the fluid pressure, which is called the pressure due to the weight of the fluid. We will look for the pressure within the fluid of density ρ , at a depth h from the surface of area A , as shown in Figure 9.2.

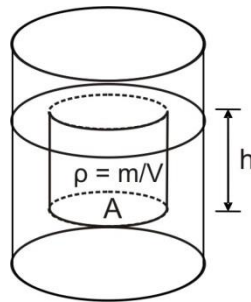

Figure 9.2. Pressure as a fluid depends on the depth h and density of the fluid.

The fluid pressure at depth due to the weight of the fluid column above the area A , ie

$$P = F / A = mg / A$$

where m is the mass of the fluid column. According to the definition of density,

$$\rho = m / V \text{ then } m = \rho V$$

where V is the volume of the fluid column. Inserting this equation into the equation m pressure, we obtain

$$P = V\rho g / A$$

The volume of the fluid column is the product of the column height h and the column cross-sectional area A , $V = hA$. Inserting this into the equation V pressure caused the area A can cancel out algebraically, $P = (hA)\rho g / A$ so we obtain the result in

$$P = \rho gh \quad \dots (9.3)$$

where h is the depth below the surface of the fluid. Thus, because the weight of the fluid pressure only depends on the density of the fluid and depth.

Example 9.1:

Calculate the water pressure at a depth of 1.50 m in the pool, if the density of water is 1000 kg/m^3 and the gravitational acceleration $g = 9.80 \text{ m/s}^2$ earth.

Completion:

Pressure due to the weight of water is

$$\begin{aligned} P &= \rho gh \\ &= (1000 \text{ kg/m}^3)(9.80 \text{ m/s}^2)(1.50 \text{ m}) \\ &= 1.47 \times 10^4 \text{ N/m}^2 \end{aligned}$$

The total pressure caused by the weight of the water and the atmospheric pressure is

$$\begin{aligned} P_{\text{tot}} &= P_{\text{atm}} + P \\ P_{\text{tot}} &= 1.013 \times 10^5 \text{ N/m}^2 + 1.47 \times 10^4 \text{ N/m}^2 \\ &= 1.16 \times 10^5 \text{ N/m}^2 \end{aligned}$$

D. Pressure Measurement

Pressure gauge are many tools that have been found, for example an open pipe manometer, aneroid manometer, tire pressure gauge, and a mercury barometer. The simplest tool is open pipe manometer, as shown in Figure 9.3. U-shaped pipe partially filled with a liquid of density ρ , usually mercury or water. Pressure P being measured height difference h is connected with the liquid surface within two feet of the pipe according to the relationship

$$P = P_{\text{atm}} + \rho gh \quad \dots (9.4)$$

Note that the scale ρgh is " pressure measurement ", ie the pressure exceeds atmospheric pressure. If the surface of the liquid in the pipe left foot lower than the liquid surface on the right foot, mean pressure P lower than atmospheric pressure, and h is negative.

In general, the pressure measurement is not expressed in multiplication ρgh , but the liquid height h . Pressure is sometimes expressed in " millimeters of mercury " (mm Hg). Because the density of mercury is $\rho = 13.6 \times 10^3 \text{ kg/m}^3$ and the gravitational acceleration $g = 9.80 \text{ m/s}^2$ is, the pressure $p = 1.00 \text{ mm Hg}$ is equivalent to

$$\begin{aligned} \rho gh &= (13.6 \times 10^3 \text{ kg/m}^3)(9.80 \text{ m/s}^2)(1.00 \times 10^{-3} \text{ m}) \\ &= 1.33 \times 10^2 \text{ N/m}^2 = 1.33 \times 10^2 \text{ Pa} \end{aligned}$$

Unit 1 mm Hg also called torr, in honor of Evangelista Torricelli (1608-1647), who invented the barometer.

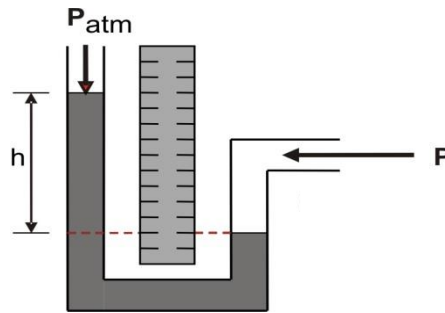

Figure 9.3. Open pipe manometer.

Atmospheric pressure is often measured with a mercury barometer, with a pipe whose one end is closed, as shown in Figure 9.4. The glass pipe stuffed full of mercury, then inverted in a vessel containing mercury. If the pipe is long, the surface of the mercury will drop, leaving a vacuum on it, because mercury can sustain mercury as high as approximately 76 cm (76.0 cm to the right standard atmospheric pressure). Thus, the column of mercury as high as 76 cm of pressure is equal to atmospheric pressure. By using the formula $P = \rho gh$, we obtain

$$\begin{aligned} P &= (13,6 \times 10^3 \text{ kg/m}^3)(9,80 \text{ m/s}^2)(0,760 \text{ m}) \\ &= 1,013 \times 10^5 \text{ N/m}^2 = 1,00 \text{ atm} \end{aligned}$$

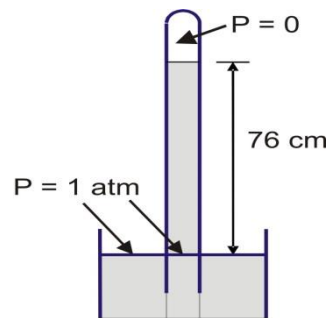

Figure 9.4. Mercury barometer, when the air pressure is 76 cm Hg.

E. Fluid Flow

Studies on the fluid motion is very closely related to biology and medicine. One of the leading experts in this field is the LM Poiseuille (1799-1869), a French physician who studied the motion of the fluid because of interest in the flow of blood in the body. There are two types of fluid flow, ie the flow laminar and turbulent flow. Laminar or streamline flow occurs when the flow is smooth, so that the fluid layers adjacent to one another glide gently. In this flow of each fluid particles follow a smooth trajectory and particle trajectories do not intersect. Above a certain speed, which depends on various factors, the flow becomes turbulent, characterized by the presence of small circles resemble whirlpools irregular and called eddy currents. Eddy currents absorb a lot of energy.

1. Bernoulli equation

If friction is negligible, incompressible fluid flow is determined by the Bernoulli equation, which gives the relationship between velocity, pressure, and elevation in a flow line. Bernoulli's equation states that at some point in the fluid channel is flowing effect relationship

$$P + \rho gh + \frac{1}{2} \rho v^2 = \text{konstan} \quad \dots (9.5)$$

Here P is the pressure in the fluid, h is the height, ρ is the density, g is the acceleration due to gravity, and v is the velocity at a point in the fluid channel. The first term Equation (9.5) is the potential energy per unit volume due to the pressure in the fluid. The second term is the gravitational potential energy per unit volume, and the third term is the kinetic energy per unit volume.

Let us consider a fluid flowing through a pipeline consisting of two parts with a cross-sectional area respectively A_1 and A_2 , as shown in Figure 9.5. Volume flow rate, the volume of fluid flowing per second through a point in the pipe, is determined by the product of the fluid velocity and extensive plumbing, $A \times v$. If it incompressible fluid, the volume flow rate in section 1 is equal to the volume flow rate in section 2, so that

$$A_1 v_1 = A_2 v_2 \quad \text{or} \quad v_2 = \frac{A_1}{A_2} v_1 \quad \dots (9.6)$$

This equation is commonly known as the continuity equation. Because A_1 is greater than A_2 , then v_2 is greater than v_1 .

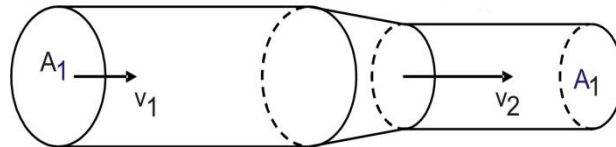

Figure 9.5. Fluid flow through a pipe with two distinct parts breadth.

Bernoulli equation at some point in section 1 and at some other point in section 2 can be written as

$$P_1 + \rho gh_1 + \frac{1}{2} \rho v_1^2 = P_2 + \rho gh_2 + \frac{1}{2} \rho v_2^2 \quad \dots (9.7)$$

with subscript 1 and 2 show the parameters at the two points in the flow. Because the two sections of the pipeline have the same height ($h_1 = h_2$), the Bernoulli equation can be simplified to

$$P_1 + \frac{1}{2} \rho v_1^2 = P_2 + \frac{1}{2} \rho v_2^2 \quad \dots (9.8)$$

Because, $v_2 = (A_1 / A_2) v_1$ the pressure in section 2 is

$$P_2 = P_1 - \frac{1}{2} \rho v_1^2 \left[\left(\frac{A_1}{A_2} \right)^2 - 1 \right] \quad \dots (9.9)$$

This relationship indicates that while the rate on part 2 increases, the pressure decreases in the segment.

2. Viscosity and Poiseuille law

Frictionless flow is an ideal flow. In a real fluid, the molecules of mutual attraction; consequently, the relative velocity between the fluid molecules countered by the frictional force, which is called the viscous friction. The term viscosity is used for friction in a fluid that prevents the fluid to flow freely, which is the friction force between the fluid layers adjacent layers over each other 's moves. Viscous friction is proportional to the flow velocity and viscosity coefficients for a particular fluid. As a result of viscous friction, velocity of fluid flowing through the pipe varies on the pipe. The highest speed at the center and decreases toward the pipe walls; fluid in the pipe wall was silent. Such fluid flow is called laminar.

If the viscosity taken into account, it can be shown that the volume flow rate Q in the laminar flow through a pipe cylinder of radius r and length L is determined by the Poiseuille law, namely:

$$Q = \frac{\pi r^4}{8\eta L} (P_1 - P_2) \quad \dots (9.10)$$

by $(P_1 - P_2)$ is the fluid pressure difference on the two ends of the cylinder and η (the Greek letter eta) is the coefficient of viscosity. In SI units of viscosity coefficient is expressed in $\text{Ns/m}^2 = \text{Pa.s}$. In the cgs system the unit is dyne.s/cm^2 , also called the poise (P). Often times the coefficient of viscosity expressed in centipoise (cP); $1 \text{ cP} = 0.01 \text{ P}$. Equation (9.10) is sometimes written in a simpler form, namely

$$Q = \frac{(P_1 - P_2)}{R} \quad \text{with} \quad R = \frac{8\eta L}{\pi r^4}$$

with R is called flow resistance.

There is a basic difference between fluid flow without friction and viscous fluid. A frictionless fluid will flow in steady state in the absence of external forces given him. This can be proved by using the Bernoulli equation, which shows that if the height and fluid velocity is constant, then there is no pressure drop along the flow path. Instead, Poiseuille equation for viscous flow state that a pressure drop is always with viscous fluid flow. By rearranging equation (9.9), we can express the pressure drop as

$$P_1 - P_2 = \frac{8\eta L}{\pi r^4} Q = RQ \quad \dots (9.11)$$

$(P_1 - P_2)$ is the pressure drop that accompanies the volume flow rate Q in a pipe whose length is L . The product of pressure and cross sectional area of the pipe is the

force required to overcome the frictional force that tends to obstruct the flow in the pipe.

3. Turbulent flow

If the fluid velocity is increased to pass through a critical point, a smooth laminar flow is interrupted. This can be done by reducing the radius of the pipe so that the more tapered shape, as shown in Figure 4.32. Flow becomes turbulent eddy currents and eddies disrupt laminar flow.

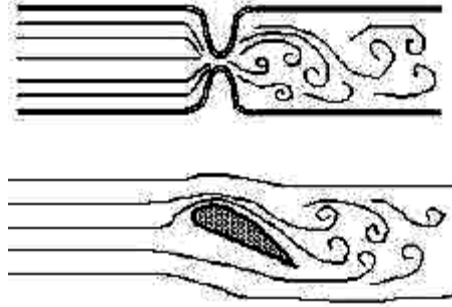

Figure 9.6. If the fluid is flowing in a long tapering tube, the fluid velocity will increase gradually until it reaches a point where the velocity exceeds the critical velocity v_c , which results in turbulent flow

In a cylindrical pipe flow velocity v_c is determined by the critical

$$v_c = \frac{R_e \eta}{\rho D} \quad \dots (9.3)$$

where D is the diameter of the cylinder, ρ is the density of the fluid, η is the viscosity. Coat R_e is the Reynolds number, for the majority of the fluid has a value between 2000 and 3000. Friction force in turbulent flow is greater than in the laminar flow. Therefore, as long as the flow turns into turbulent, it becomes more difficult to move the fluid in the pipe.

Example 9.2:

Someone has the aorta with a radius of approximately 1.0 cm and the flow rate of blood in it is 30 cm /s. Capillaries have a certain radius of 3.0×10^{-4} cm and flow rate of blood in it is 9.0×10^{-4} m / s. What is the approximate number of capillaries in the body of the man?

Completion:

Suppose we use the subscript 1 and subscript 2 to the aorta to the capillaries. Aortic cross-sectional area A_1 is

$$A_1 = \pi r_1^2$$

with $r_1 = 1.0 \text{ cm} = 1.0 \times 10^{-2} \text{ m}$ is the radius of the aorta. If the capillary number is n , then the total capillary cross-sectional area A_2 is

$$A_2 = n\pi r_2^2$$

with $r_2 = 3.0 \times 10^{-4} \text{ cm} = 3.0 \times 10^{-6} \text{ m}$. The rate of blood flow in the aorta is $v_1 = 30 \text{ cm/s} = 0.30 \text{ m/s}$ and the rate of blood flow in the capillaries is $v_2 = 9.0 \times 10^{-4} \text{ m/s}$. Using the continuity equation we obtain

$$A_1 v_1 = A_2 v_2$$

$$\pi r_1^2 v_1 = n\pi r_2^2 v_2$$

$$n = \frac{r_1^2 v_1}{r_2^2 v_2}$$

$$n = \left(\frac{1.0 \times 10^{-2} \text{ m}}{3.0 \times 10^{-6} \text{ m}} \right)^2 \left(\frac{0.30 \text{ m/s}}{9.0 \times 10^{-4} \text{ m/s}} \right)$$

$$n = 3.7 \times 10^9$$

F. Some Examples of Pressure in The Human Body

There are several examples of pressure in the human body. Some examples are blood pressure, bladder pressure, brain pressure, eye pressure, and so on. Table 9.2 shows the typical pressure of the fluid in the human body.

Table 9.2.

Typical fluid pressure in the human body

Typical fluid pressure	Pressure (mm Hg)
Arterial blood pressure	
Maximum (systolic):	
adult	100-140
baby	60-70
Minimum (diastolic):	
adult	60-90
baby	30-40
Venous blood pressure	
venules	8-15
Veins	4-8
Large vein (CVP = Central venous pressure)	4
Capillary blood pressure	
end of the arterioles	35
end of venules	15
bladder	
Average	0-25
during micturition	110
Brain, lying (CSF = Cerebrospinal liquid)	5-12

Typical fluid pressure	Pressure (mm Hg)
Eye, the aqueous humor	12-24
<i>Gastrointestinal</i>	10-20
<i>Intrathoracic</i>	-4 until -8
Middle ear	<1

1. Bladder pressure

One of the most noticeable of the body pressure, bladder pressure varies with a large enough range. The pressure was zero when the bladder is empty and steady rise to about 25 mm Hg when the bladder reaches its normal capacity of about 500 cm³. Micturition reflex induced by bladder pressure of approximately 25 mm Hg. This reflex stimulates the feeling to urinate, and then trigger the contraction of the muscles around the bladder to increase bladder pressure to 110 mm Hg, so that accentuate feeling to urinate. Cough, tension, sit (upright), tight clothing, and nervous tension can also increase bladder pressure and micturition reflex triggered long before the bladder is full. Students who are studying for exams, the authors are pursuing the deadline for publishing frequent trips to the restroom to pee. Pregnant women experiencing bladder pressure is increased because of the fetus which is above the bladder, so he frequent urination. Bladder capacity is also less than 500 cm³ because the space occupied fetus. Urinary bladder when the pressure is generally 15-30 mm Hg, but urinary tract disorders, such as swelling of the prostate gland, can force the pressure to 70 mm Hg. The greater the obstacle the channel, the greater the pressure difference needed to cause the same flow rate.

Bladder pressure can be measured by catheterization through the urethra or by inserting a needle through the abdominal wall into the bladder called direct cystometry. Two of these techniques continue bladder pressure through a liquid into a measuring device, usually a water manometer. Because the easiest to use water pressure to continue it and to fill the manometer, bladder pressure is usually specified in centimeters of water. Normal range is from 0 to 30 cm of water, up to 150 cm of water during the micturition reflex.

2. Pressure Serebrospina

The skull and spinal fluid contains serebrospina (CSF = cerebrospinal fluid), as shown in Figure 9.7. CSF support the weight of the brain with buoyancy, works as a protective cushion, and supplying nutrients are filtered from the blood. CSF is produced in the skull and circulates around the brain, through cavities in the brain called ventricles, and down to the spinal cord central canal. CSF is usually absorbed in the spinal CSF as soon as generated in the skull. However, ventricular narrow channel called the cerebrum can be clogged, causing increased pressure inside the skull. This is a fairly common problem in infants known as hidrosepalus (hydrocephalus) and can cause an enlarged head, mental illness or death. When hidrosepalus detected in time, the pressure and the effect can be minimized by surgery.

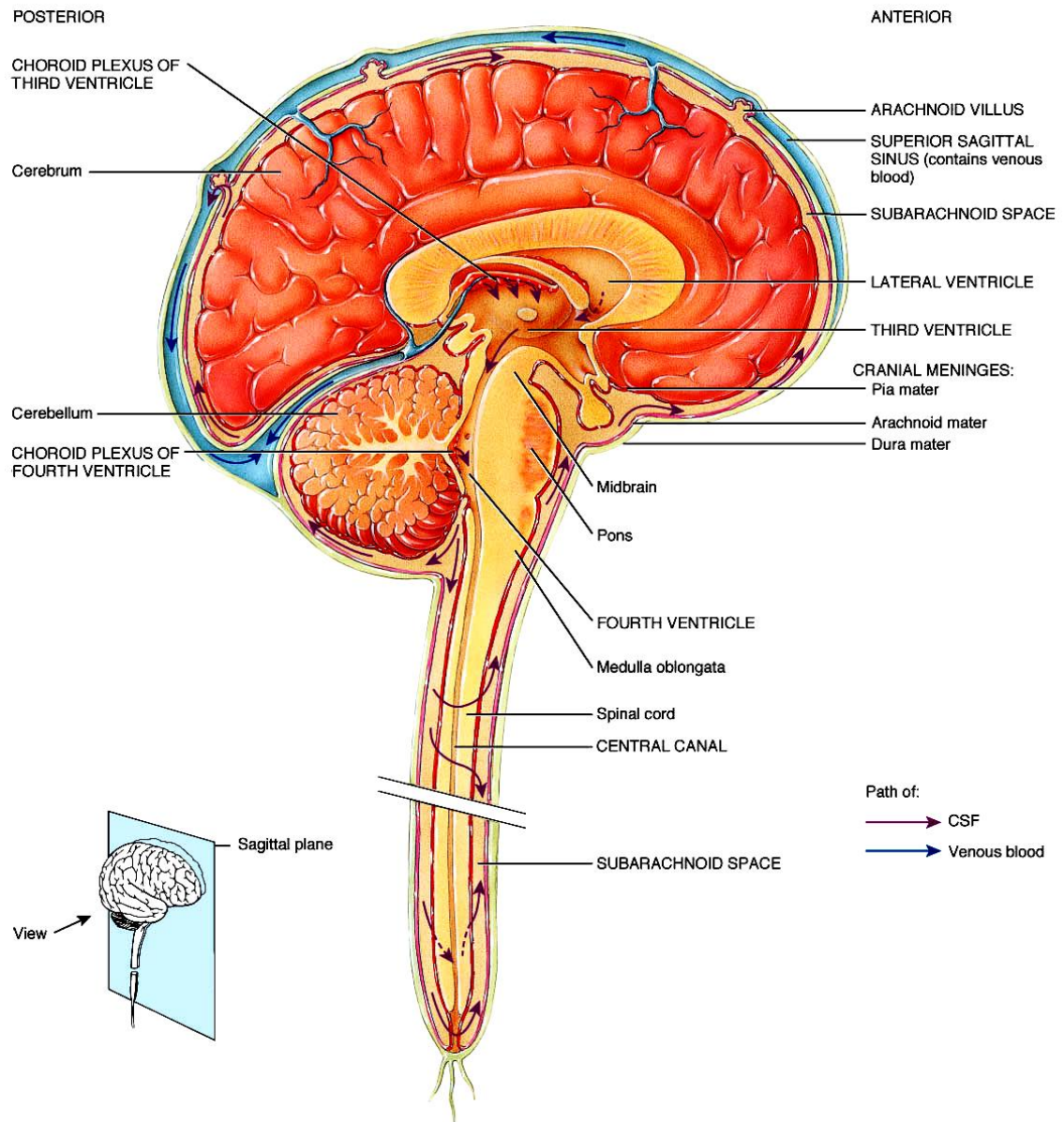

(a) Sagittal section of brain and spinal cord

Figure 9.7. Brain, spinal cord, and CSF. The arrows indicate the circulation of CSF (<http://classroom.sdmesa.edu/eschmid/>)

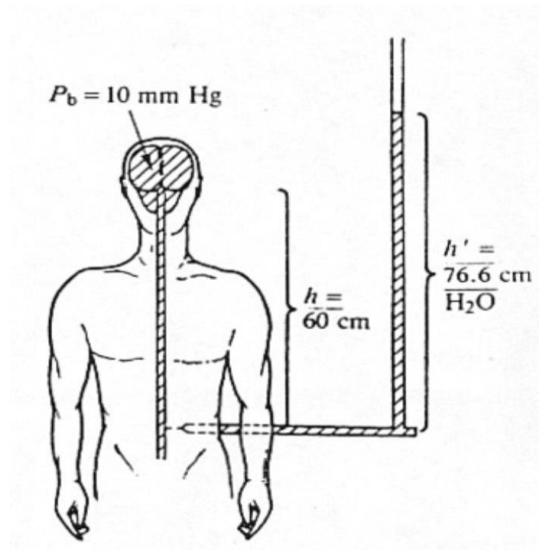

Figure 9.8. Water manometer is used to measure the CSF pressure, as in Example 4.7 (Urone, 1986: 183).

Example 9.3:

If the pressure in the CSF were measured in a way as shown in Figure 4.34, using a spinal tap with the patient sitting upright, then the pressure due to the weight in the spinal CSF pressure increase. How much pressure is measured in centimeters of water if the pressure around the brain is approximately 10 mm Hg, and taps are at a point 60 cm below the brain? The density of CSF is 1.05 g/cm^3 .

Completion:

Since the basic manometer located at the same height with the needle, the pressure measured in the manometer is

$$P = \rho gh + P_{\text{otak}}$$

$$P = (1,05 \times 10^3 \text{ kg/m}^3)(9,80 \text{ m/s}^2)(0,60 \text{ m}) + (0,01 \text{ m})(13,6 \times 10^3 \text{ kg/m}^3)(9,80 \text{ m/s}^2)$$

$$= 6174 \text{ N/m}^2 + 1332,8 \text{ N/m}^2$$

$$= 7506,8 \text{ N/m}^2$$

This pressure can be expressed in cm H₂O using the relation $P = \rho_{\text{air}} g h_{\text{air}}$, so that we obtain

$$h_{\text{air}} = \frac{P}{\rho_{\text{air}} g}$$

$$h_{\text{air}} = \frac{7506,8 \text{ N/m}^2}{(1000 \text{ kg/m}^3)(9,80 \text{ m/s}^2)}$$

$$h_{\text{air}} = 0,766 \text{ m H}_2\text{O} = 76,6 \text{ cm H}_2\text{O}$$

In CSF pressure can be measured by the method as shown in Figure 4.34. Unfortunately, this method can not detect hidrocephalus, due to a blockage in the

cerebral channel blocking more pressure in the brain to be forwarded to the spine. Not easy to determine the pressure of the brain directly because of bone structure, so other methods need to be used to detect hidrocephalus. These methods include irradiating light through the baby's skull is still soft, ultrasonic irradiation (ultrasound scans), and x-rays.

3. Gastrointestinal Pressure

Food, drinks and the residue moves through the digestive tract or gastrointestinal (GI) along approximately 6 m have the property or similar fluid - fluid. The flow is regulated by stress and in particular by the sphincter muscle and valves in the system. The pressure in the GI system is usually positive, as shown in Table 4.2. The esophagus is the exception; pressure is directly related to the pressure in the chest cavity and the pressure is negative. Pleural pressure is sometimes monitored by pressure gauges in the esophagus. Required in connection sphincter of the esophagus and stomach to prevent the backflow of gastric fluid. During swallowing, the muscles in the esophagus push the working fluid into the stomach.

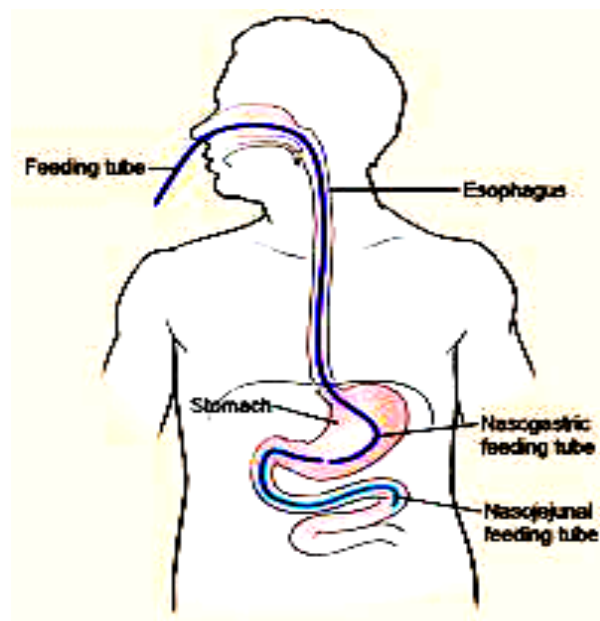

Figure 9.9. Eating and drug delivery can be done nasogastric tube. Fluid pressure because of ρgh , exceeds the pressure in the stomach (webmm,ahrq.gov).

Stomach is elastic, so that the pressure inside it increases little by little. Become great only when the stomach is fully charged. Hunger occurs when gastric pressure is low. The pressure depends on the capacity of the stomach, which can change the eating habits. Gastric an extraordinary stretch when people overeat constantly, and a relatively large gastric emptiness triggers hunger before the people really need food. Feeding methods commonly used for the ailing patient shown in Figure 9.9. A pipe is inserted through the patient's nose and down through the esophagus into the stomach (called a nasogastric tube). Fluid can pass through the pipe down by gravity because the

pressure in the stomach is not so great. The feeding method is useful for patients who are hard to swallow but can not be charged for the vomiting.

Increased pressure in the GI system because the air is swallowed or by fart produced by the work of bacteria, can cause seizures. This is especially seen in infants, who often swallow air while eating. Blockage in the GI system also causes increased pressure, even to the extent of the outbreak due to fluid buildup.

G. Cardiovascular System

The cardiovascular system is responsible for transporting nutrients and removing gaseous waste from the body. This system is comprised of the heart and the circulatory system. Structures of the cardiovascular system include the heart, blood vessels, and blood. The lymphatic system is also closely associated with the cardiovascular system.

Structures of the Cardiovascular System are: (1) **Heart**; The heart is the organ that supplies blood and oxygen to all parts of the body. This amazing muscle produces electrical impulses through a process called cardiac conduction. These impulses cause the heart to contract and then relax, producing what is known as a heart beat. The beating of the heart drives the cardiac cycle which pumps blood to cells and tissues of the body, (2) **Blood Vessels**; Blood vessels are intricate networks of hollow tubes that transport blood throughout the entire body. Blood travels from the heart via arteries to smaller arterioles, then to capillaries or sinusoids, to venules, to veins and back to the heart. Through the process of microcirculation, substances such as oxygen, carbon dioxide, nutrients, and wastes are exchanged between the blood and the fluid that surrounds cells, (3) **Blood**; The blood delivers nutrients to cells and removes wastes that are produced during cellular processes, such as cellular respiration. Blood is composed of red blood cells, white blood cells, platelets, and plasma. Red blood cells contain enormous amounts of a protein called **hemoglobin**. This iron containing molecule binds oxygen as oxygen molecules enter blood vessels in the lungs and transport them to various parts of the body. After depositing oxygen to tissue and cells, red blood cells pick up carbon dioxide (CO₂) for transportation to the lungs where CO₂ is expelled from the body (<http://biology.about.com/od/organsystems/ss/cardiovascular-system.htm>).

Many characteristics of the cardiovascular system which can be explained by the laws of physics. Cardiovascular system consists of two pumps (left side and right side of the heart) and a complex arrangement of pipes that drain blood through almost every part of the body.

1. Heart as a double pump

The heart is a pump whose walls are made of thick muscle. They can squeeze (contract) to send blood rushing out. The blood does not spill all over the place when it leaves the heart. Instead, it flows smoothly in tubes called **blood vessels**. The heart pumps blood, all around but you can really subdivide the whole heart into two halves and think of it as a double pump. One part pumps oxygen-poor blood to the lungs to deposit carbon dioxide, pick up oxygen and go to the other side where it's going to pump the freshly oxygenated blood to the rest of the body until it arrives

back to the first part to deposit the carbon dioxide. This double-circuit circulation is the way the heart works in all mammals and prevents deoxygenated and oxygenated blood from mixing. Heart of mammals, including humans, consists of two independent pump, each made up of two chambers called the foyer (the atria) and the chamber (ventricle). The porch is a chamber which is the reservoir for the main pump. The entrance to and exit from the chambers is controlled by the valves are arranged to maintain blood flow in the right direction. Work human heart shown in Figure 9.10. The porch pumps blood to the booth. Heart valves are opened or closed by the pressure difference to him. In addition, the opening of the valves between the porch and the chambers aided by the tendons attached to the interior chamber. Blood is almost incompressible, then when the heart chambers to pump blood out of the heart, aorta bubbles additional blood sucking.

For the picture below: The left blue side is the right side, the left is the right. These blue vessels go to the lungs, and go to enter the left side heart, where the **oxygen rich blood** (the standard is to display that in red) is going to go to the rest of the body. Gases are exchanged and then the **oxygen-poor-blood** comes back to the right side. So that's your overall plan.

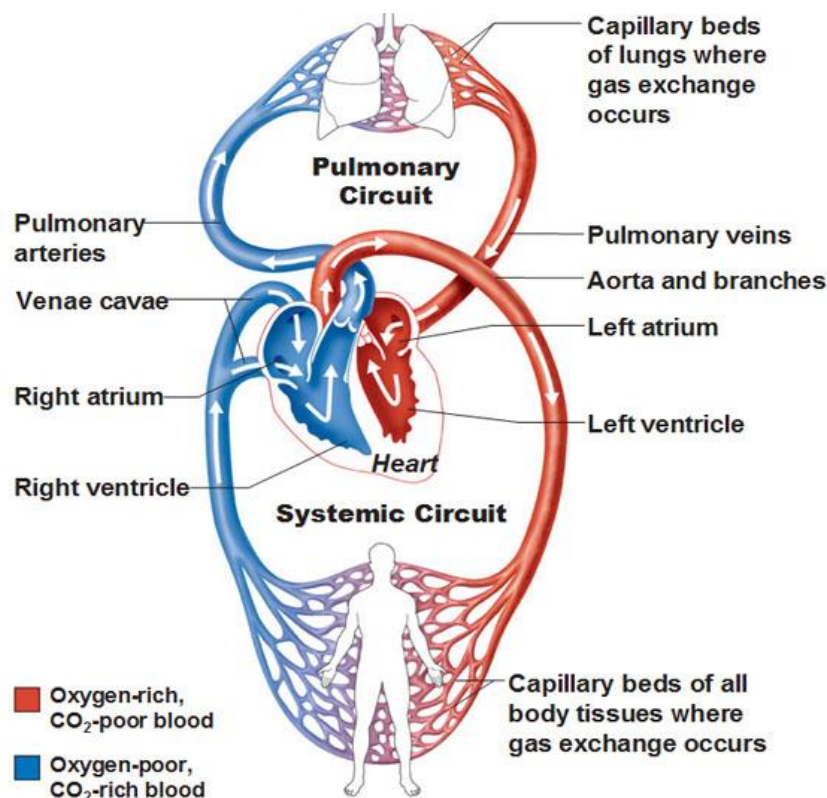

Figure 9.10. The heart as a double pump, the pulmonary and systemic circuit (<http://antranik.org/intro-to-the-heart/>).

2. Circulatory system

Figure 9.11 shows the chart of the human circulatory system. Blood in the circulatory system carries oxygen, nutrients, and various other essential substances to the cells and removes the waste metabolic remnants of the cells. Blood is pumped through the circulatory system by the heart, and the blood leaves the heart through vessels called arteries and back to the heart through vessels called veins.

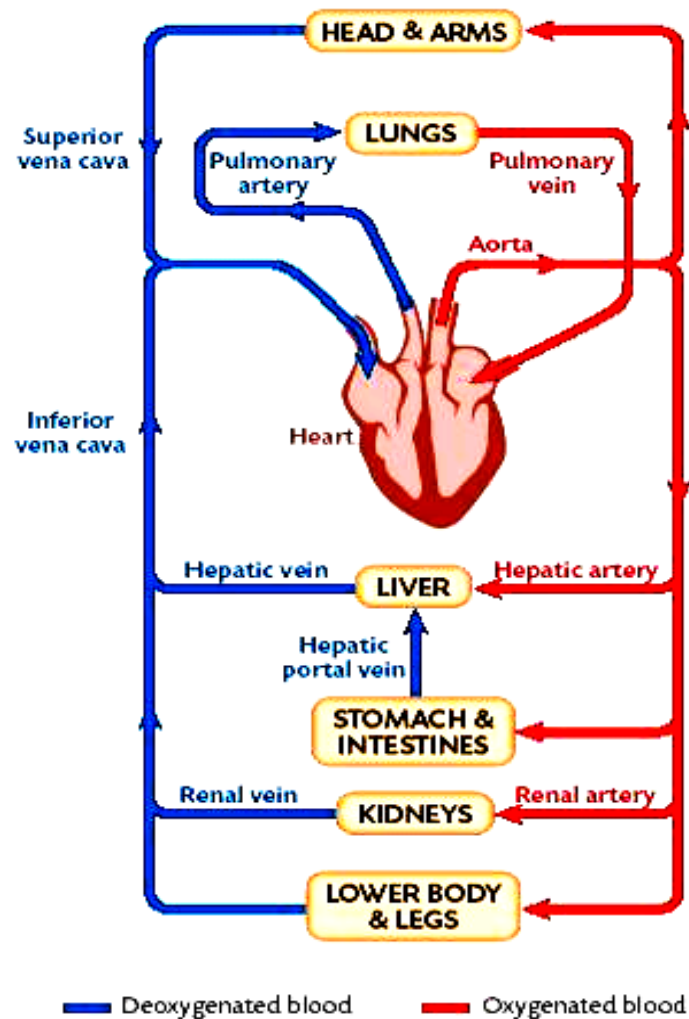

Figure 9.11. Chart blood circulation in humans
([http://leavingbio.net/circulatory system/circulatory system.htm](http://leavingbio.net/circulatory%20system/circulatory%20system.htm))

Blood from all parts of the body except the lungs get into the right atrium, which contracts and forces blood into the right ventricle. The right ventricle then contracts and pushes blood through the pulmonary artery into the lungs. In his travels through the lungs, the blood releases CO₂ (carbon dioxide) and absorb O₂ (oxygen), then the blood flows into the left atrium through the pulmonary veins. Contraction of the left ventricle forces blood into the left ventricle, which contracts and pushes blood rich in oxygen through the aorta into the arteries leading to all parts of the body except the lungs. Thus, the right side of the heart pumps blood

pumping through the lungs, and the left side of the heart pumps blood through the body's other organs.

Large artery, called the aorta, which carries oxygenated blood from the left ventricle of the heart, artery branches into smaller arteries, leading to various parts of the body. These arteries branch out further into the arteries smaller, smaller arteries called arterioles most. Arterioles is what plays an important role in regulating blood flow to particular areas of the body. These arterioles branching further into narrow capillaries are often wide enough to allow passage of single blood cells.

Capillaries spread through the network so much that almost all cells in the body adjacent to a capillary. Exchange of gases, nutrients, and waste discharges between blood and the surrounding tissues occurs due to diffusion through the thin capillary walls. Capillaries merge into small veins called venules, which subsequently merged into the veins that carry the greater the oxygen - poor blood to the right atrium of the heart.

3. Blood Pressure

Blood flow refers to the movement of blood through a vessel, tissue, or organ, and is usually expressed in terms of volume of blood per unit of time. It is initiated by the contraction of the ventricles of the heart. Ventricular contraction ejects blood into the major arteries, resulting in flow from regions of higher pressure to regions of lower pressure, as blood encounters smaller arteries and arterioles, then capillaries, then the venules and veins of the venous system. This section discusses a number of critical variables that contribute to blood flow throughout the body. It also discusses the factors that impede or slow blood flow, a phenomenon known as resistance (<http://cnx.org/content/m46635/>).

As noted earlier, hydrostatic pressure is the force exerted by a fluid due to gravitational pull, usually against the wall of the container in which it is located. One form of hydrostatic pressure is blood pressure, the force exerted by blood upon the walls of the blood vessels or the chambers of the heart. Blood pressure may be measured in capillaries and veins, as well as the vessels of the pulmonary circulation; however, the term blood pressure without any specific descriptors typically refers to systemic arterial blood pressure, that is, the pressure of blood flowing in the arteries of the systemic circulation. In clinical practice, this pressure is measured in mm Hg and is usually obtained using the brachial artery of the arm.

Contraction porch and chambers of the heart is triggered by electrical pulses given simultaneously in the left hemisphere and the right hemisphere of the heart. At first the porch to contract, forcing blood into the chambers; later chambers to contract, forcing blood out of the heart. Because of the heart pumping blood into the arteries in the form of pulses. The maximum pressure that pushes blood to the peak of the pulse is called systolic pressure. Lowest blood pressure between pulses is called the diastolic pressure. When systemic arterial blood pressure is measured, it is recorded as a ratio of two numbers (e.g., 120/80 is a normal adult blood pressure),

expressed as systolic pressure over diastolic pressure. The systolic pressure is the higher value (typically around 120 mm Hg) and reflects the arterial pressure resulting from the ejection of blood during ventricular contraction, or systole. The diastolic pressure is the lower value (usually about 80 mm Hg) and represents the arterial pressure of blood during ventricular relaxation, or diastole.

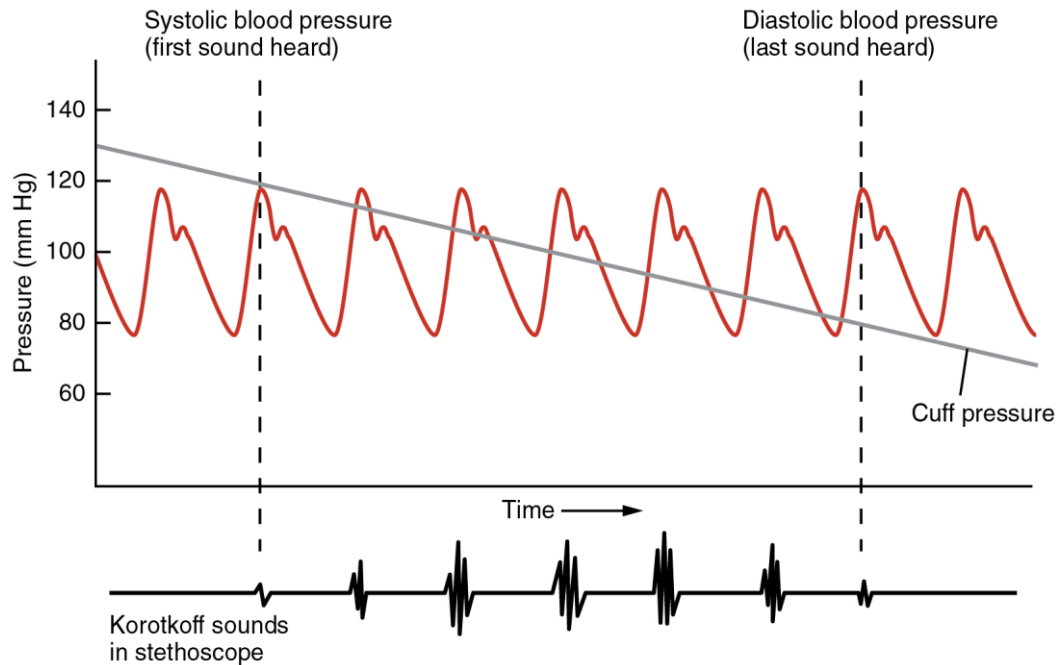

Graph 9.12. Blood pressure versus time graph in large arteries (<http://cnx.org/content/m46635/>).

During the flow of blood through the circulatory system, the energy initially, which is given by the heart pumping work, disappears through two mechanisms: missing associated with the expansion and contraction of artery walls and viscous friction associated with blood flow. Because of this energy loss, the pressure fluctuations are refined during the early blood away from the heart, and the average pressure drop. Toward the blood reaches the capillaries, the flow becomes smoother and blood pressure is only about 30 mm Hg. Pressure still dropped lower and close to zero just before returning to the heart. At the end of this flow rate, the movement of blood through the veins is assisted by muscle contractions that squeeze blood toward the heart.

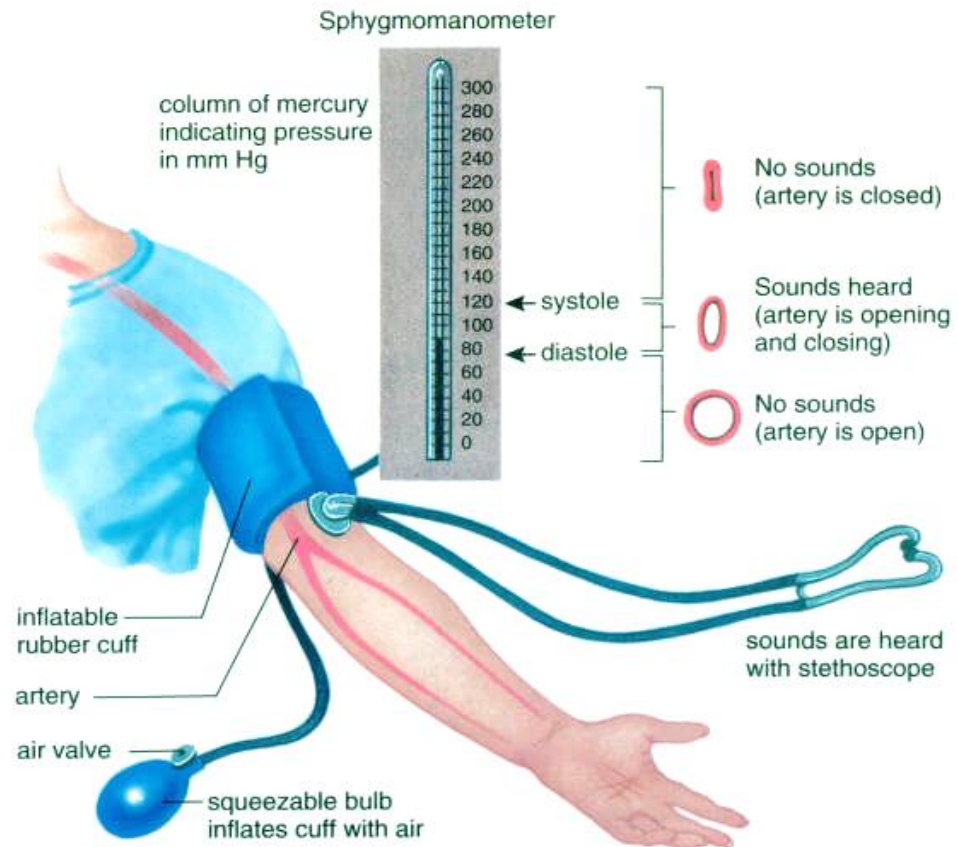

Figure 9.13. Measuring blood pressure using a sphygmomanometer (http://homepage.smc.edu/wissmann_paul/anatomy1/1bloodpressure.html).

Blood pressure can be measured indirectly using a sphygmomanometer, as shown in Figure 9.13. The cuff is placed on the upper arm and inflated with a hand pump until arterial blood flow in the arm stops. The pressure created by squeezing the hand pump and forwarded by air in the pipes (fluid confined) to the cuff and to gauge (manometer). The cuff pressure continues to be forwarded to the arm arteries. When the applied pressure exceeds the pressure generated by the heart, arteries stop blood flow. Measurements were performed by slowly releasing the air from the cuff, lowering the pressure, and listening to the blood flow through the stethoscope placed in the artery under the cuff. No sound is heard until the pressure in the cuff drops to the systolic pressure. Just below this point the blood begins to flow through the arteries; however, because the artery is still partially depressed, the flow is turbulent and is accompanied by a distinctive sound. Pressure seen at the beginning of the sound is the systolic blood pressure. As long as the pressure in the cuff is lowered further, the arteries expand to their normal size, the flow becomes laminar, and noise disappears. The pressure at which the sound disappears is taken as diastolic blood pressure.

4. Pressure Around the Circulatory System

The circulatory system is responsible for circulating (moving) blood throughout the body. The heart and the blood vessels are the most important parts of the circulatory system. The heart is a central organ in the circulatory system. With each beat it forces blood into the blood vessels which transport or carry oxygen and nutrients to all of the tissues and organs (the arteries) of the body and then blood returns back to the heart through the veins (www.veinforum.org).

There are three different types of blood vessels which play different roles within the circulatory system. The two main blood vessels are the **arteries** and the **veins**. The arteries carry the blood loaded with oxygen and nutrients away from the heart and the veins return the “used” blood, which has had the oxygen and nutrients removed, back to the heart. The **lymphatic vessels** are the third component. Briefly, they act as a “clean-up” system to pick up fluid, protein, and other debris left behind by the veins. They filter and clean the fluid before returning it to the heart. Barriers in the circulatory system cause pressure drops for the blood to flow around the system. The idea that the resistance causes a pressure drop has been discussed previously. Remember that for laminar and turbulent flow effect.

$$P_1 - P_2 = QR$$

P_1 is the pressure at the entrance of the pipe and P_2 is the pressure at the exit of the pipe. The pressure drop is proportional to the barrier and flow rate. Resistance R is highly dependent on the radius, so the drop in pressure in the aorta is quite small, while the capillary is quite large. However, there are so many capillaries so that the flow rate through the capillary is a small one, and the pressure drop is not too big. There is only a slight drop in pressure in the venous system of the capillaries back to the heart. This is caused by two large vein that returns blood to the heart from the right side of each having a size larger than the aorta. The right side of the heart raises blood pressure to pump blood through the lungs. Barriers lungs lowers blood pressure before entering into the left side of the heart, where the process continues.

There is one thing that needs to be emphasized. Decrease the speed of the aorta to the capillaries are not caused by resistance to flow. Barriers to cause a decrease in pressure but does not affect the speed. It can be seen from the fact that the speed increased again in vein while the pressure remains down in the veins leading to the heart. Branching and merging back blood vessels similar happens in the lungs. Low blood velocity required in the capillaries and capillaries needed as well as possible to enable the effective transport of substances between the blood and the areas between the diffusion and slow processes are related.

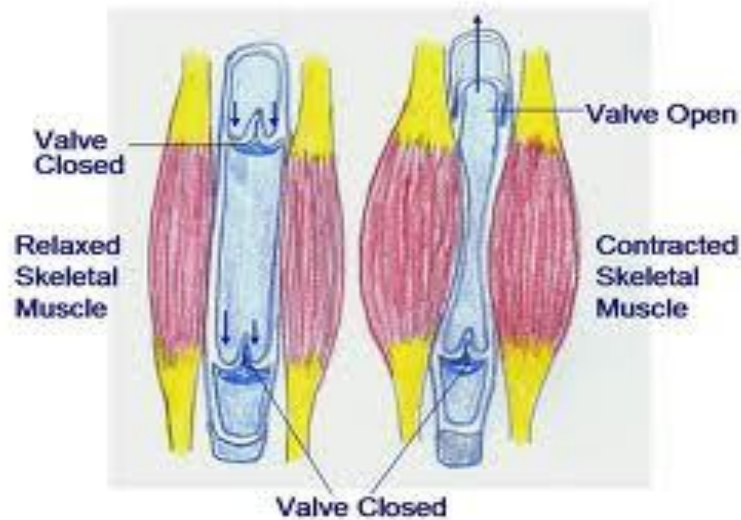

Figure 9.14. Muscle pumps in the venous system helps the blood returns to the heart from the legs and arms. (a) When a muscle contracts, blood is forced out. (b) one -way valves in the veins allow blood to flow only toward the heart (ceessential.net).

5. The influence of gravity on the circulatory system.

Gravity affects the pressure but not the flow rate and circulatory system. In a closed system, the pressure due to gravity has no effect on the net flow rate, as well as the atmosphere that does not have an influence on the flow of the IV (intravenous). Note the flow from the heart to the legs and back to the heart in people who are standing, as shown in Figure 9.15. Gravity has the same direction with the flow down, and in the opposite direction to the flow upward, so gravity has no net effect; gravity does not help or hinder the flow and a loop (loop) as a closed circulatory system.

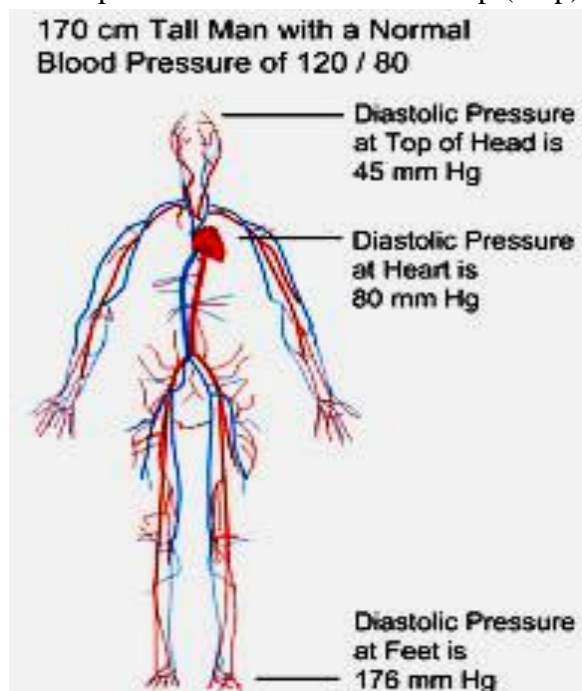

Figure 9.15. Blood pressure in the large arteries of the heart and increase under reduced over the heart due to gravity (Urone, 1986: 201).

Gravitational stability influence on the fluid. Recall from the previous discussion that $P = \rho gh$, where h is the depth of the fluid and ρ is the fluid density, and g is the acceleration due to gravity. One thing that is easy to measure h on the heart in the circulatory system. For someone who is standing, the pressure in the large arteries of the heart and increase under reduced over the heart of ρgh , where h is a positive for any point below the heart and negative for any point above the heart (pressure drop due to such small obstacles in the large arteries so it can be ignored). Therefore, the blood pressure in the large arteries in the head is

$$P_{\text{head}} = P_{\text{heart}} - \rho gh_{\text{head}} \quad \dots (9.4)$$

This can cause fainting if P_{head} too low. The pressure in the large arteries in the legs are

$$P_{\text{legs}} = P_{\text{heart}} + \rho gh_{\text{legs}} \quad \dots (9.5)$$

Greater pressure on the foot can lead to accumulation of fluid as reverse osmosis through capillary walls, especially for people who stand for hours a day.

6. Energy and Power Are Given Heart

Cardiac clearly does work and expend energy. Eventually, all the energy released as heat energy boils heart. Nevertheless, early heart gives blood in three forms. Blood kinetic energy gained during accelerated blood out of the heart into the circulatory system. Heart also gives the gravitational potential energy to the blood being pumped to a higher point. Other forms of potential energy that is given to raise the blood pressure when the heart blood. During circulate blood throughout the body, its energy is converted into heat energy by the flow resistance or by fluid friction. In order to more easily observe the fluid kinetic energy and potential energy per unit volume. The potential energy per unit volume in a fluid is determined by

$$EP/V = \rho gh + P \quad \dots (9.6)$$

the EP is the potential energy, V is the volume, h is the depth, ρ is the density, g is the acceleration due to gravity, and P is the pressure. Notice what happens to the potential energy of blood during its journey through the circulatory system. Blood pressure is reduced due to the flow resistance of an average of 100 mm Hg in the aorta to approximately 4 mm Hg when the blood went back into the heart. Pgh tribe unchanged during the trip, but the pressure is reduced, so that the potential energy is lost; actual, potential energy is converted into heat energy during stress is reduced because of the obstacles. No energy is converted into heat energy when there is no movement, therefore EP/V is constant in a static fluid and the pressure only depends on the depth in a static fluid.

The kinetic energy per unit volume in the fluid is $E_K/V = \frac{1}{2} \rho v^2$. Because m/V is the fluid density ρ , the kinetic energy per unit volume in a fluid is

$$E_K/V = \frac{1}{2} \rho v^2 \quad \dots (9.7)$$

Summing the kinetic energy and potential energy per unit volume in a fluid gives the total energy per unit volume in the fluid

$$E/V = E_K/V + E_P/V$$

so that

$$E/V = \frac{1}{2} \rho v^2 + \rho gh + P \quad \dots (9.8)$$

E is the total energy. To find the power supplied by the heart, this equation is solved for the total energy E is given by the heart

$$E = (\frac{1}{2} \rho v^2 + \rho gh + P)V$$

Power delivered by the heart is the energy supplied per unit time, so that

$$\text{Power} = \frac{E}{t} = (\frac{1}{2} \rho v^2 + \rho gh + P) \frac{V}{t}$$

Due to the volume of time is divided by the volume flow rate Q , then

$$\text{Power} = (\frac{1}{2} \rho v^2 + \rho gh + P)Q \quad \dots (9.9)$$

Each term in this equation illustrates the power that is given for a specific purpose. The first term illustrates the power that is given to raise the blood rate v , which is called kinetic energy. While the third term is given the power to raise the pressure P , which is called the power of pressure. The second term can be ignored for the heart because h is not raised directly by the heart.

EXERCISE

To improve your understanding of the material above, do the exercises below!

- 1) Inflation of an aneurysm is a weakened vessel wall due. Calculate the maximum pressure in Newton carried by the blood to the aneurysm in the aorta which gives the maximum blood pressure 140 mm Hg and a broad aneurysm that is 20 cm².
- 2) The average rate of a fluid in a pipe of radius 4.0 cm is 25 cm / s. If the pipe narrows so that its radius is 2.0 cm, how many cm / s average rate of the fluid?
- 3) A patient infused glucose solution with a density of 1.05 g/cm³. The surface of the glucose solution infusion bottle is at a height 1.0 m above the needle is injected in the patient's hand. If the Earth's gravitational acceleration $g = 9.80 \text{ m/s}^2$ is, how many mm Hg pressure given the glucose solution?

- 4) Repeat Example 4.7 if the patient is lying in state. For normal adults, the rate of blood from the left ventricle of heart was 30 cm / s, volume flow rate was 83 cm³ / s, a density of 1.05 g/cm³ was blood, and the pressure is 120 mm Hg. Calculate the kinetic energy, pressure energy, and the total power generated by the heart 's left ventricle.

Instructions to Answer Exercise

If you have difficulty in completing these exercises, consult the instructions for the completion of each of the following questions.

- 1) Change the pressure of 140 mm Hg into N/m² using the equation $P = \rho gh$, with $\rho = 13.6 \times 10^3 \text{ kg/m}^3$ is the density of mercury, $g = 9.80 \text{ m/s}^2$ is the acceleration due to gravity, and $h = 140 \text{ mm Hg} = 0.140 \text{ m Hg}$. Then calculate the force equation $F = PA$.
- 2) Use Equation (9.6).
- 3) Pressure glucose can be calculated with the formula: if the density expressed in kg/m³, g in m/s², and h in m, it will obtain the P in N/m². To transform this into m Hg pressure, use formula, with $\rho_{\text{Hg}} = 13.6 \times 10^3 \text{ kg/m}^3$, which can be converted to mm Hg.
- 4) In this case there is no influence of pressure due to gravity, so the measured pressure equal to 10 mm Hg, which can be converted into cm H₂O.
- 5) Use Equation (9.9). Be careful with the units used.

RESUME

Pressure is the force exerted per unit area. If the force F acts on the extent of the field A , then the pressure P is

$$P = \frac{F}{A}$$

The pressure at a depth h in a fluid is determined by $P = \rho gh$

ρ is the fluid density and g is the acceleration due to gravity. P_{tot} total working pressure at that depth can be written as $P_{\text{tot}} = P_{\text{atm}} + \rho gh$.

P_{atm} is the atmospheric pressure. ρgh pressure is the pressure measurement, the pressure above or below atmospheric pressure.

Pascal's principle states that the external pressure is given in an enclosed fluid will be transmitted equally to all parts of the fluid. Based on the principle of fluid pressure can be measured with a manometer. Air at atmospheric pressure measured by a barometer.

Some examples of pressure in the human body include bladder pressure, serebrospina pressure, gastrointestinal pressure, and blood pressure.

Volume flow rate of fluid is the volume of fluid which passes through a point per unit time. Volume flow rate of fluid flowing through a closed pipe is constant, which can be expressed as the product of the fluid velocity and the cross sectional area of the pipe, which can be written as

$$A_1 v_1 = A_2 v_2$$

This equation is often called the continuity equation.

$$P + \rho gh + \frac{1}{2} \rho v^2 = \text{Constant}$$

If friction is negligible, incompressible fluid flow is determined by the Bernoulli equation, which gives the relationship between the velocity v , pressure P , and the elevation h in a flow line. Bernoulli's equation states that at some point in the fluid channel is flowing effect relationship, ρ is the density and g is the acceleration due to gravity.

If the viscosity taken into account, the volume flow rate Q in the laminar flow through a pipe with a cylindrical spokes, r and length L is determined by the Poiseuille law, namely

$$Q = \frac{\pi r^4}{8\eta L} (P_1 - P_2)$$

by $(P_1 - P_2)$ is the pressure difference between the ends of the pipe, η is the viscosity of the fluid.

If the fluid velocity is increased to pass through a critical point, a smooth laminar flow is interrupted. This can be done by reducing the radius of the pipe so that the more tapered shape, the flow becomes turbulent eddy currents and eddies disrupt laminar flow.

In a cylindrical pipe flow velocity v_c is determined by the critical

$$v_c = \frac{R_e \eta}{\rho D}$$

where D is the diameter of the cylinder, ρ is the density of the fluid, η is the viscosity. Coat R_e is the Reynolds number.

Due to the volume of time is divided by the volume flow rate Q , the power supplied by the heart is

$$\text{Power} = \left(\frac{1}{2} \rho v^2 + \rho gh + P \right) Q$$

The first term illustrates the power that is given to raise the blood rate v , which is called kinetic energy. While the third term is given the power to raise the pressure P , which is called the power of pressure. The second term can be ignored for the heart because h is not raised directly by the heart.

CHAPTER 10 THE BIOELECTRIC CELL

A. The Nature of Bioelectricity

Bioelectricity is fundamental to all of life's processes. Indeed, placing electrodes on the human body, or on any living thing, and connecting them to a sensitive voltmeter will show an assortment of both steady and time-varying electric potentials depending on where the electrodes are placed. These biopotentials result from complex biochemical processes, and their study is known as *electrophysiology*. We can derive much information about the function, health, and well-being of living things by the study of these potentials. To do this effectively, we need to understand how bioelectricity is generated, propagated, and optimally measured. Bioelectricity is a cellular phenomenon. Every living cell has a membrane potential (of about -70mV), with the inside of the cell being negative relative to its external surface. The cell membrane potential is strongly linked to the cell membrane transport mechanisms in that much of the material that passes across the membrane is ionic (charged particles), thus if the movement of charged particles changes, then it will influence the membrane potential. Conversely, if the membrane potential changes, it will influence the movement of ions.

Although the fluid inside and outside cells is essentially neutral, there is a difference in ion concentration that produces electricity potential at cell boundaries. The cells which generate an electric potential creates a thin layer of negative charge on the surface of the boundary and a thin layer of positive charge on the outer surface of the membrane is the boundary. (see Figure 10.1).

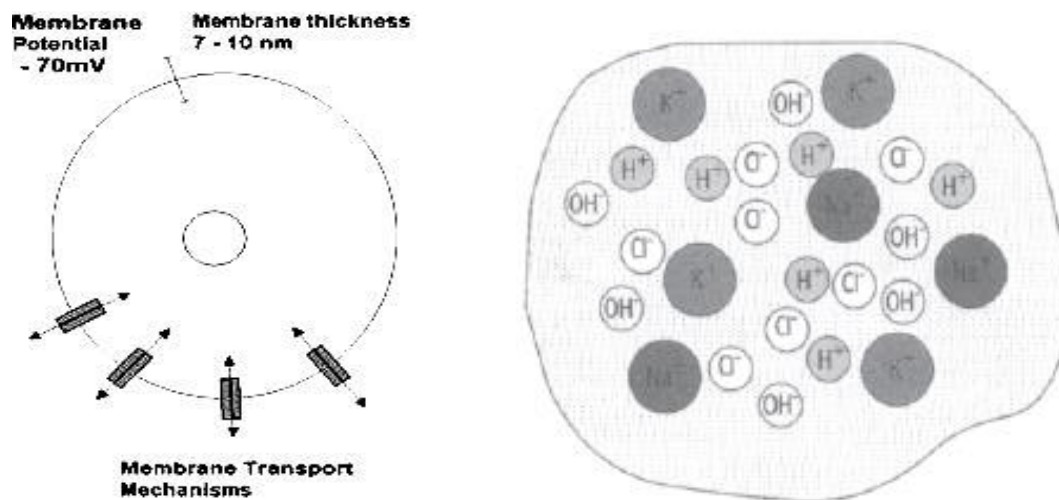

Figure 10.1. All living things have a net electroneutrality, meaning that they contain equal numbers of positive and negatively charged ions within their biological fluids and structure.

The most fundamental bioelectric processes of life occur at the level of membranes. In living things, there are many processes that create segregation of charge and so produce electric fields within cells and tissues. Bioelectric events start when cells expend metabolic energy to actively transport sodium outside the cell and potassium inside the cell. The movement of sodium, potassium, chloride, and, to a lesser extent, calcium and

magnesium ions occurs through the functionality of molecular pumps and selective channels within the cell membrane.

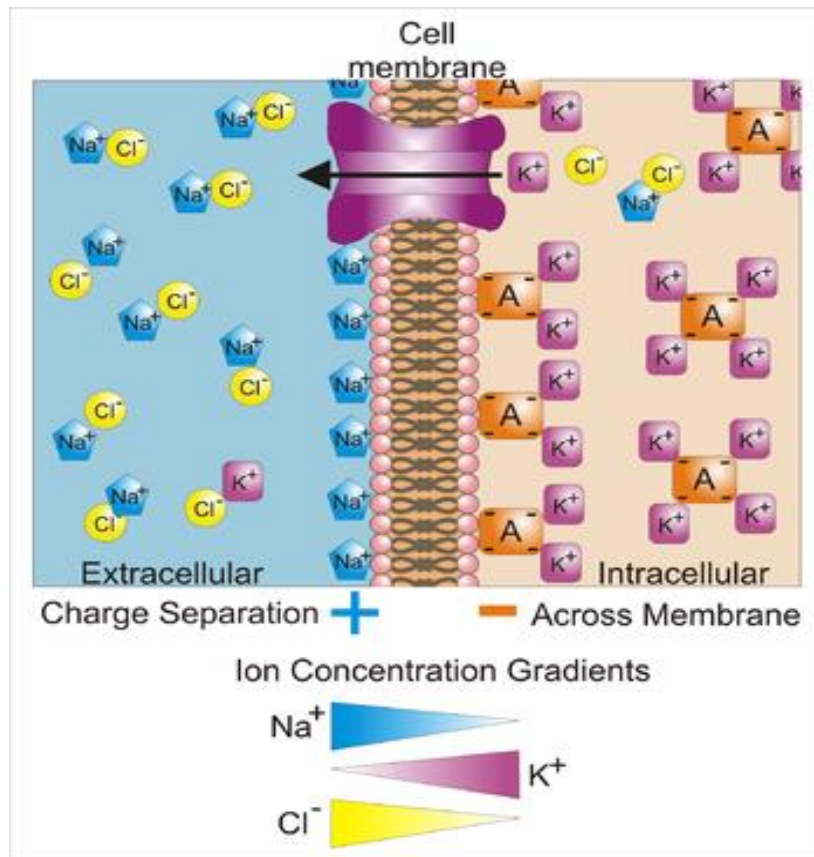

Figure 10.2. The concentrations of ions outside and inside the cell. Positive ion concentrations digrafikkan above the line and negative ion concentrations digrafikkan below the line to help describe that fluids are electrically neutral. The membrane is permeable to ions K^+ and Cl^- ions, which diffuses in the opposite direction as shown. Short arrows indicate that the Coulomb force continuously inhibit the diffusion of K^+ ions and Cl^- ions. If the membrane becomes permeable to Na^+ ions, the diffusion gradient and Coulomb forces work to drive Na^+ into the cell.

There are many ions in the cells inside and outside fluid. Ions are important in creating the cell potentials are ions Na^+ , K^+ , and Cl^- . There is a big difference in the concentration of these ions inside and outside the cells, as shown in Figure 10.2 (a). Negative ions other than Cl^- indicated by A^- . Note that the total charge inside and outside is zero, thereby, the fluids that are electrically neutral.

To see how the cell potential is formed, consider what happens in the example of the cell membrane initially neutral and have different concentrations as shown in Figure 10.2 The cell membrane is normally impermeable to K^+ and Cl^- ions; membrane was approximately 100 times less permeable to Na^+ and highly impermeable to other ions. Only K^+ and Cl^- which diffuses through the cell membrane in goodly numbers. Net diffusion direction is from the area of high concentration to areas of low concentration.

Therefore, the ions K^+ and Cl^- ions diffuse in the opposite direction, as shown in Figure 10.2 (b). Ions K^+ and Cl^- ions have opposite charge, then there is a very strong Coulomb attractive force between the ions that cause the ions to form two thin layers of charge right at the side of the cell membrane, as shown in Figure 10.2.

Diffusion of K^+ and Cl^- continues until the attractive force and repulsive Coulomb stop. During the charge layers are formed on the cell membrane, increasing the Coulomb forces. Tensile similar charges not work to attract ions of K^+ and Cl^- back into its regions with high concentration. Furthermore, the repulsive force similar charges work to maintain the ions in order not to leave the area with a high concentration. An equilibrium is quickly reached between the diffusion of high concentration to low concentration and Coulomb forces opposite. As soon as this equilibrium is reached, the cells are in a resting state (resting state). If more of the ions K^+ and Cl^- diffuse through the cell membrane, increasing Coulomb forces and some ions move back. Net displacement is zero so that the equilibrium is stable. Coulomb force is very strong, and only about 1 out of 100,000 ions K^+ and Cl^- move through the membrane. This is such a small part that does not change the overall concentration of ions. After all the fluid inside and outside the cell remains essentially neutral although some have a separate charge. However, the small charge separation is very important, because it is a source separation Bioelectricity . Potential in the cells of 70-90 mV lower than the potential outside the cell, approximately 90 mV in the nerve cells and muscle. Potential outside the cell is usually taken 0 V, resulting in the nerve cells and muscle has a resting potential of approximately -90 mV.

Equilibrium between the concentration gradient and the Coulomb force is also an energy equilibrium. Proper equilibrium electric potential energy with the potential energy due to the concentration difference is, the ability to conduct business concentration gradient by moving ions against electric potential. Energy balance equation that describes this is the Nernst equation. Nernst equation gives the voltage that will be created by the difference in concentration, but this equation only for a membrane that is permeable to a single type of ion perfect and perfect is not permeable to all other ions. In this environment the Nernst equation is

$$V = V_{in} - V_{out} = -2,30 \frac{kT}{Ze} (\log C_{in} - \log C_{out}) \quad \dots (10.1)$$

where V is the potential difference (inside minus outside), C_{in} and C_{out} are the concentrations of ions to which the membrane is permeable, k is Boltzmann's constant, T is the absolute temperature, and Ze is the charge on the ion multiplied by the electron charge (Z is valence ions). The minus sign indicates that the excess positive ions can diffuse in the fluid inside the cell produces a negative voltage in the cell. The most important aspect is that the Nernst equation potential difference is proportional to the concentration difference.

Using concentrations are given in Figure 10.2 (a), we can calculate how much potential that will be created by each type of membrane permeable to ions if the ion itself. For Na^+ the result is a potential in the +109 mV. Since the actual potential in the nerve approximately -90 mV, indicating that the membrane is not very permeable to Na^+ . For K^+ and Cl^- respectively the result is -88 mV and -70 mV. These results approach the actual

values in many types, but it need not imply that the membrane is permeable to K^+ and Cl^- . This only implies that if the membrane is permeable to K^+ and Cl^- , there is a slight movement under resting conditions.

The structure and characteristics of the membrane are topics of research interest. Many things are not yet understood, but it can be stated that the resting potential is definitely a big influence membrane structure and characteristics. Although only 90 mV resting potential, it is at ptensial membranes which have an average thickness of 8 nm. So the voltage per meter is very large, on the order of 11 MV per meter. Voltage per meter is so big it can straighten molecules and have an influence on the pore and membrane permeability. For example, if the potential at the membrane, the membrane permeability change drastically, suddenly becomes about 1000 times more permeable to Na^+ than the existing ones. No one knows exactly why the permeability change, but one reason is the potential effect on the membrane structure. Nature has to find a way to use such permeability changes to continue Bioelectricity signals.

Example 10.1:

Calculate the potential of the membrane to K^+ ions at a temperature of 310 K, if the concentration of K^+ ions inside the cell is 140 mol/m³ and outside the cell is 10 mol/m³. Boltzmaan constant $k = 1.38 \times 10^{-23}$ J / K. K^+ ion charge is $e = 1.60 \times 10^{-19}$ C.

Completion:

We use equation (10.1) with $z = 1$, in order to obtain

$$V = V_{in} - V_{out} = -2,30 \frac{kT}{Ze} (\log C_{in} - \log C_{out})$$

$$V = -2,30 \frac{(1,38 \times 10^{-23} \text{ J/K})(310 \text{ K})}{(1)(1,60 \times 10^{-19} \text{ C})} (\log 140 \text{ mol/m}^3 - \log 5 \text{ mol/m}^3)$$

$$V = (-614,9625 \times 10^{-4})(1,447158032) \text{ volt}$$

$$V = -88,9947921 \times 10^{-3} \text{ volt}$$

$$V = -89 \text{ mV.}$$

B. Neural System

The use of electrical phenomenon in most living organisms found in animal nervous system. Nerve cells are also called neurons form a complex network in the body that receive, process and forward information from one part of the body to other body parts. Center is located in the brain tissue, which has the ability to store and analyze information. Based on this information the nervous system controls various body parts. The nervous

system is very complex. For example, the human nervous system consists of about 1010 neurons that are connected. Therefore, it is not surprising that the overall function is still little understood, although the nervous system has been studied for hundreds of years. It is not known how the information is stored and processed by the nervous system; are also unknown how neurons grow into certain patterns to the function. However, some aspects of the nervous system is now well recognized. In particular, over 40 years ago, methods of propagation of nerve through the nervous system have been established firmly. The messages are electrical impulses transmitted by neurons. When a neuron receives an appropriate stimulus neurons that generate electrical pulses that propagated along the cable-like structure. Pulses was large and its duration is constant, not depending on the intensity of stimulation. The strength of the stimulus is carried by a number of pulses generated. When the pulses reach the end of the " wiring, " pulses that activate neurons or other muscle cells.

1. Neurons

Neurons, which is the basic unit of the nervous system, can be divided into three groups: sensory neurons (sensory), motor neurons, and interneurons (neurons connecting). Sensory neurons receive sensory stimuli from the external environment and internal monitoring body. Depending on the particular function, sensory neurons carry messages about such factors of heat, light, pressure, muscle tension, and smell to the centers of higher nervous system for processing. Motor neurons carry messages that control muscle cells. These messages are based on information provided by the sensory neurons and central nervous system located in the brain. Connecting neuron passing information between neurons.

When neurons rise, neurons that transmit signals consisting of electric Bio temporary reversal of the membrane potential of neurons. Reversal potential originated from a localized area of the neuron and propagate along the membrane to the other locations. Reversal potential is called depolarization. Potential cells immediately return to a state of normal or negative polarity at the break with a positive and beyond. Back to the resting state is called repolarization.

Each neuron consists of a cell body which is where the nerve endings input (called dendrites) attached and a long tail (called axons) that propagate signals from the neuron cell body. Dendrites carry signals from the sensor into the body 's cells. Consider Figure 10.3. Axons or nerve fibers carry signals or Bioelectricity impulses from the nerve cell body to the muscles, glands, or other neurons. Several types of stimuli can trigger neurons continue to rise and nerve impulses to some other place. The types of stimuli that include changes in pressure, temperature changes, electrical signals from other neurons, the electrical currents from the outside, and chemical substances transmitted through the connection between the neurons (called synapses)

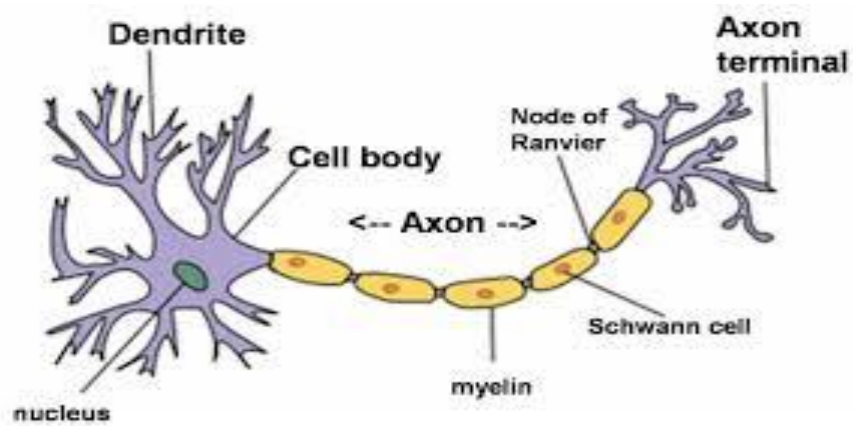

Figure 10.3. Neurons (user.tamuk.edu).

A sensory-motor neuron circuit shown in Figure 10.4 is simple. A stimulation of the muscle generates nerve impulses spread to the spine. Here the signal is transmitted to the motor neurons, which in turn send impulses to the muscle control. Most of the nerve relationship is much more complicated.

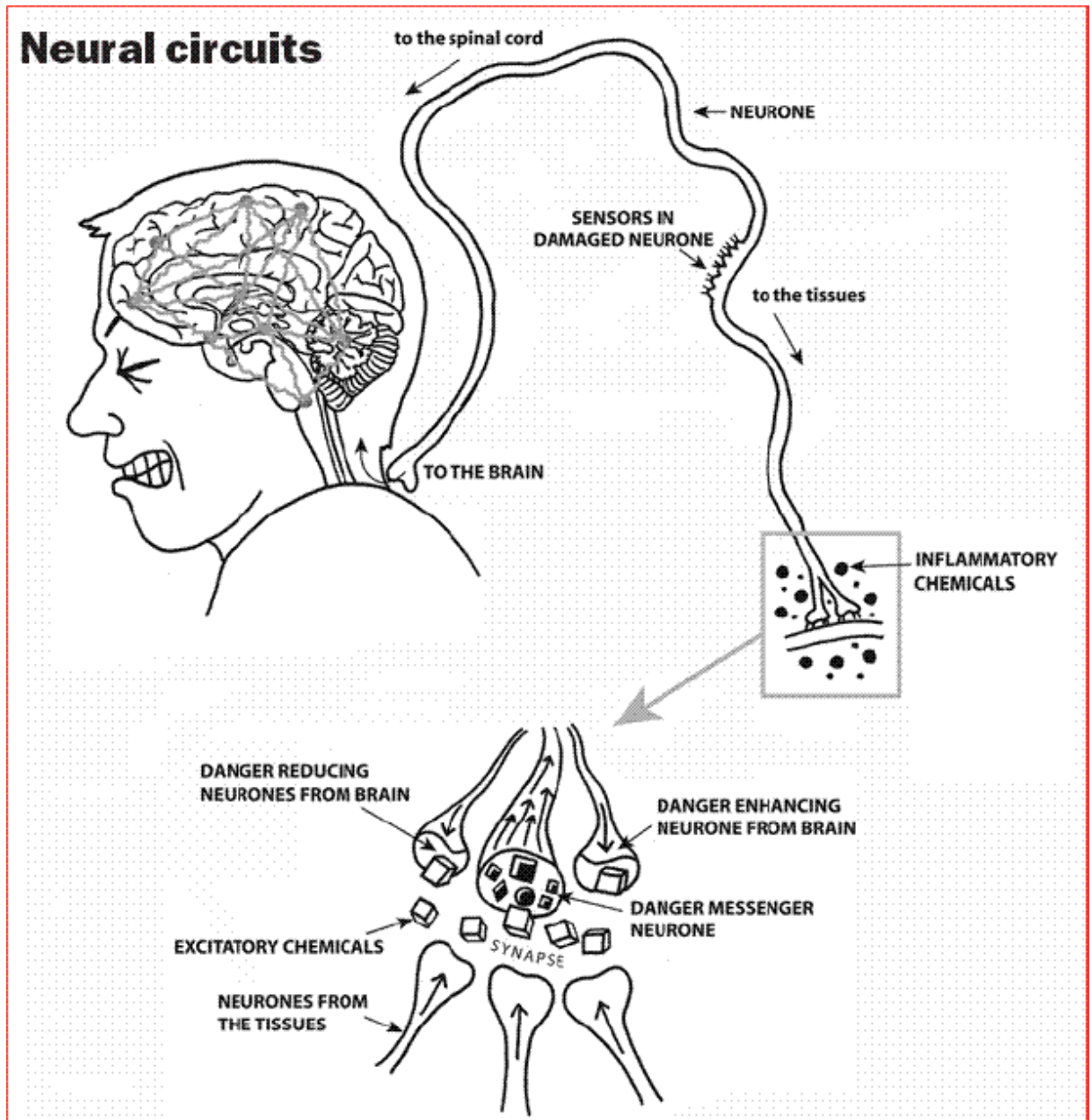

Figure 10.4. Simple neural circuit

Axon, which is an extension of neuronal cells, delivering electrical impulses from the cell body. Some really long axons. For example, in people, axons that connect the spine and the fingers and toes of more than one meter panjangnya. Some axons are wrapped with jointed sheath of a fatty substance called myelin. The sections approximately 2 mm in length, separated by gaps called nodes of Ranvier. The myelin sheath increases the rate of pulse propagation along the axon. Although each axon propagate their signals itself independently, often many axons that share common trajectory in the body. These axons are usually grouped into a nerve bundle.

The ability of neurons to forward messages caused by the electrical characteristics of the particular axon. Most of the data on the electrical properties and

chemical axon obtained by inserting a needle-like instrument investigation into the axon. By means of such an inquiry it is possible to measure the currents flowing in the axons and to take samples of their chemical composition. Such experiments are usually difficult because most of the axon diameter is very small. Even the largest axons in the human nervous system has a diameter of only about 20 μm . However, the squid has a very large axons with a diameter of approximately 1000 μm (= 0.10 mm) is large enough to include such an investigation tool.

2. Electric Potential in The Axon and The Action Potential

In the aqueous environment of the body, salt and various molecules dissociate into ions of positive and negative. As a result, the body fluid is a good conductor of electricity. Neural processing of nerve signals propagate up and can be understood by taking into account two factors, namely diffusion through a semipermeable membrane and the Coulomb force, as our earlier discussion. Furthermore, active transport processes must be included to maintain the cell potential in a long period of time.

When a nerve stimulation causes the rise, stimuli that increase cell membrane permeability to Na^+ . Cell membrane to approximately 1000 times more permeable to Na^+ than the normal state, making it approximately 10 times more permeable to Na^+ than K^+ . Because of differences in the concentration of Na^+ is large, rapid diffusion of Na^+ ions into the cell occurs. The influx of Na^+ makes the cell interior positive rather than negative. Potential inside the cell resting potential increased from -90 mV to about +40 mV. This is the depolarization which is the first stage in the overall process. This is shown in Figure 10.5 (a). Dipole layer on the membrane essentially been reversed, but only a small fraction of the ions need to move to a potential reverse.

The reversal potential on the cell membrane (depolarization) apparently alters the structure such that the two membrane permeability changes occur. First, the permeability to Na^+ returned to normal (very small), and second, the K^+ permeability increases by a factor of 30 while. The first change is to desist from further entry of Na^+ , and the second change allows the diffusion of K^+ out quickly. So the membrane potential back to its normal resting value; thus, the membrane was repolarisasi. Dipole layer has been set back only by a small net loss in the concentration gradient that drives the system. Finally, the K^+ permeability returned to normal, which is the end of the process. These events are depicted in Figure 10.5 (a), and the graph membrane permeability to Na^+ and K^+ as a function of time is shown in Figure 10.5 (b).

Cell potential changes from negative to positive and back again during depolarization- repolarization equal to a voltage pulse. This is a voltage pulse and the nerve impulse called an action potential. In Figure 10.5 (a) a nerve action potential digambarkan. Action potentials can occur in most animal cells, but it has some of the action potential of the most important influences in the nerve cells and muscle. Neurons can forward to another action potential, creating a variety of responses. In muscle cells causes contraction of muscle action potentials. As in neurons, the action potential in muscle cells may originate within the cell itself or diimbaskan by outside sources.

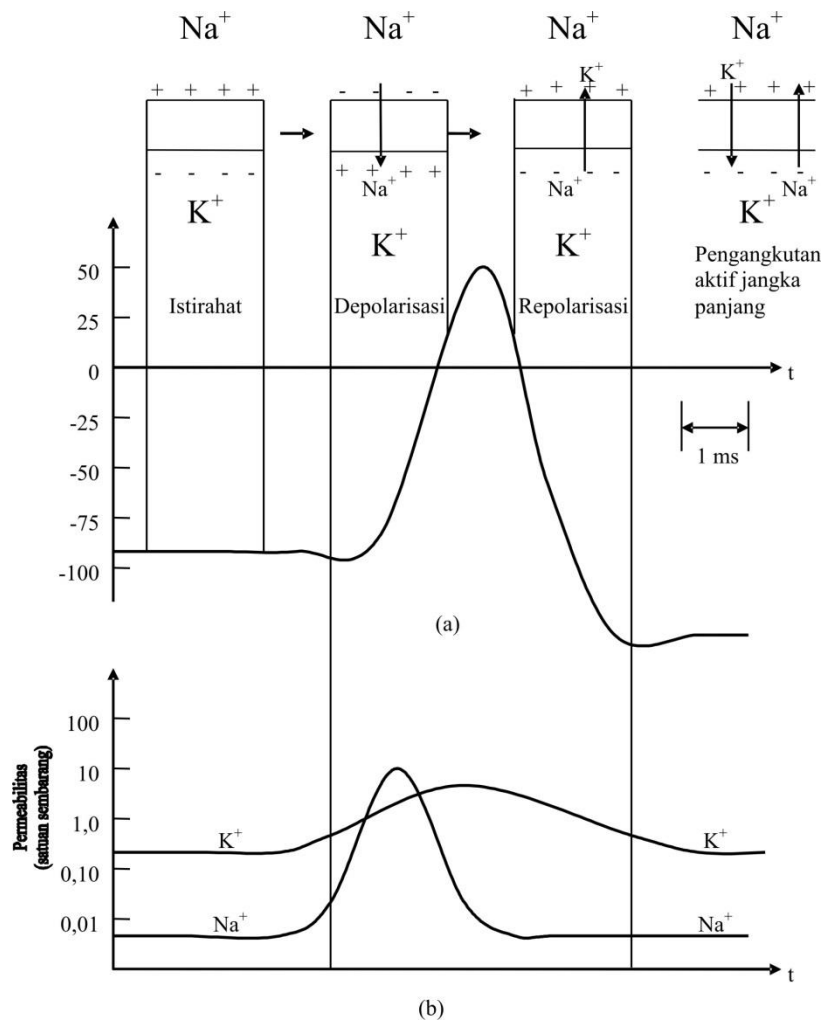

Figure 10.5. (a) The action potential in a particular place on a nerve. The voltage in the neurons was described as a function of time. Rapid movement of ions occurs only during depolarization- repolarization. Active transport is used for the long term to maintain the concentration gradient. (b) Changes in membrane permeability associated during the action potential. Note the logarithmic scale for permeability.

Every time there is a cell rise in net loss of ions Na^+ and K^+ from each of the high concentration region. It should be noted that the amount of ions through the cell membrane for the generation of a very small part of the existing ions. Remember that only one out of 100,000 ions Na^+ and K^+ are necessary to create resting potential, and similar small part of the existing ions move through the cell membrane during generation. So the nerves rise rapidly and repeated hundreds of times before the concentration of Na^+ and K^+ quite emptied.

During the long period of time these cells have to get a way to move out of the interior Na^+ and K^+ back into the interior to maintain the concentration difference creates a potential resting potential and encourage action. To do this it must utilize active transport for the active transport of Na^+ and was moving against the concentration gradient of K^+ and Na^+ against the Coulomb force. Trace studies have shown that the cells move out of the Na^+ ions for every K^+ ion-driven entry.

Therefore, active transport is done is called the sodium- potassium pump. Active transport requires energy and a part that can be measured from a cell metabolism is provided to maintain the resting potential and push the action potential. Active transport is not necessary to maintain the concentration gradient of Cl^- in neurons. Neuron membrane is highly permeable to Cl^- and Coulomb forces move back and forth through the membrane during depolarization- repolarization. Hence the influx of Cl^- is smaller when the interior becomes positive during depolarization and outflow of Cl^- similar when the interior back to negative.

Description of the action potential and the graph in Figure 10.10 tells what happened at a particular place on a cell membrane. How can this potential be forwarded to another place? The answer is that the pressure changes during depolarization of an area sufficient to alter the permeability and therefore mendepolarisasikan adjacent areas of the cell membrane. So depolarization-repolarization process in Figure 10.5 is stimulated in the adjacent cell membrane shortly after starting at a point. Adjacent regions is further stimulate additional cell membranes further, and action potential propagated along the cell membrane as shown in Figure 10.6. Of course, the propagation of the action potential is not restricted to cells where the action potential begins. Neurons can forward action potentials to other neurons, glands, and muscles. The brain is an extreme example of the relationship between the neurons are complicated.

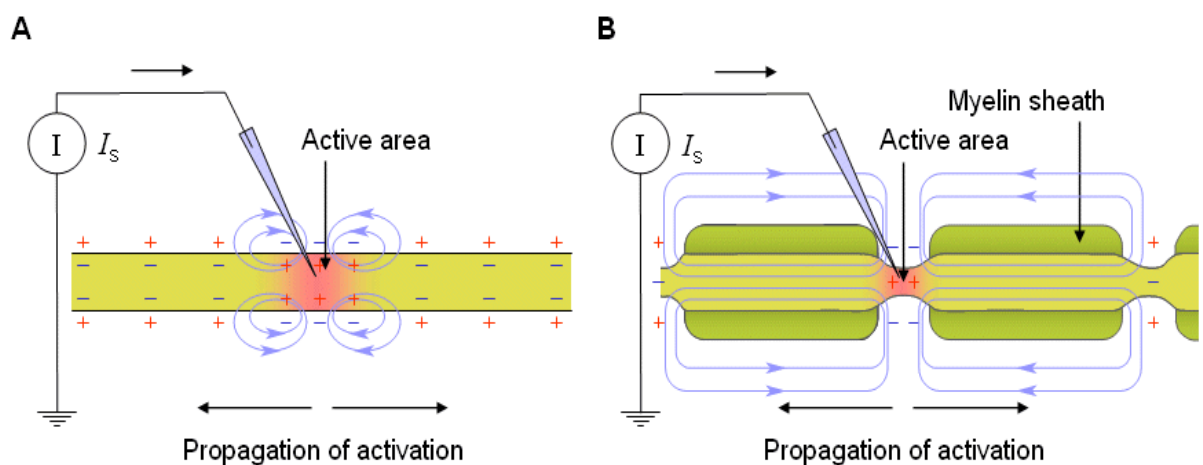

Figure 10.6. The propagation of an action potential across the membrane. A rangsangan alter membrane permeability to Na^+ ions, triggering an action potential. Furthermore, the action potential change in membrane permeability adjacent and action potential propagates out from the starting point as shown.

Figure 10.6B shows the axon of a nerve cell with sections wrapped in myelin sheaths and small crevices between the myelin sheath- sheath called nodes of Ranvier. Axons are wrapped in myelin has certain advantages than axons are not encased in myelin. Electrically isolating myelin sheath of axons of generation by another axon

carries nerve bundle that allows signals without "cross talk" between axons of different nerves. The rate of propagation of axons wrapped in myelin is much larger than the axons are not encased in myelin, which is 130 m/s in axons with myelin than 0.10 m/s in axons without myelin. Furthermore, the energy needed to transmit a signal to axons wrapped in myelin is much smaller than the axons are not encased in myelin. Both types of axons were present throughout the body, and has been thought that the development of the myelin sheath is an important evolutionary step.

The reason that the axons are wrapped in myelin sheaths deliver signals with greater speed and using less energy must use properties insulating myelin. Consider Figure 10.6B, which shows the propagation of nerve impulses along the axon wrapped in myelin. When a nerve impulse or action potential reaches the myelin sheath, nerve impulses or action potentials did not cause much of ions to pass through the axons as the myelin sheath of axons of fluid separates the outside. Action potential propagates along the myelin sheath similar to a voltage pulse that will propagate through the ordinary resistor, the voltage goes missing during the action potential (recall that $V = IR$ is the voltage drop across a resistor) but it moves very fast.

Voltage pulses will eventually become too small to stimulate something on the tip of the axon, the voltage pulse was regenerated periodically in the nodes of Ranvier. When the voltage pulse reaches the nodes of Ranvier, the voltage pulse was still large enough to stimulate the depolarization- repolarization cycle, generate an action potential is sent to the full voltage will axons regenerated on each successive gap. Ranvier nodes working as a small-amplifier amplifier along the axon. Energy consumption by the sodium- potassium pump does not have to work hard to maintain the concentration gradient, because such a small amount of cargo passing through the axon membrane in air- myelin area. The rate of propagation is larger than the axons are not encased in a myelin because most axons wrapped in myelin. Indeed, the rate of the myelin sheath is so great compared with the gaps so that the action potential seems almost jump from one gap to the next gap. Such propagation is called propagation of jumps (saltatory).

Bioelectricity generation and propagation is a complex process involving some physical events that occur simultaneously, such as diffusion, Coulomb force, and active transport. Nevertheless, many basic properties of Bioelectricity at the cellular level that can be understood by the principles of physics. Of course a detailed understanding requires a lot of knowledge about the chemistry and biology as well as physics go, but some issues are still a mystery.

3. Axon as Electrical Wiring

In the analysis of the electrical properties of the axon we will use some of the techniques of electrical engineering. It is necessary to understand the nervous system.

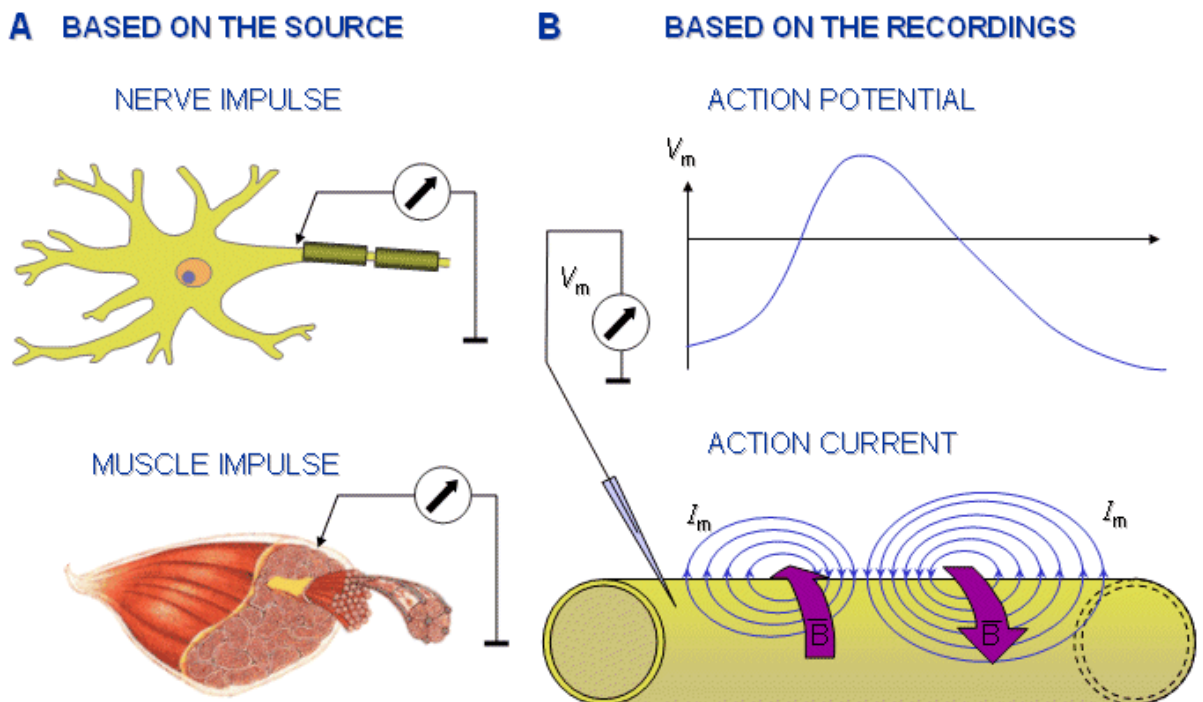

Figure 10.8. Clarification of the terminology used in connection with the action impulse: A) The source of the action impulse may be nerve or muscle cell. Correspondingly it is called a nerve impulse or a muscle impulse. B) The electric quantity measured from the action impulse may be potential or current. Correspondingly the recording is called an action potential or an action current. (<http://www.bem.fi/book/02/02.htm>).

Although axons are often compared to electrical cables, there is a big difference between the two. Nevertheless, it is possible to gain insight into the function of axons by analyzing it as a power cable that is immersed in a conductive fluid. In such an analysis, we must take into account the fluid resistance inside and outside the axon and the axon membrane electrical properties. Because the membrane is a leaky insulator, membranes have the capacity and resistance characteristics. Therefore we need four parameters to determine the nature of the axon cable.

Capacitance and resistance axons continuously distributed throughout the length of the cable. Therefore, something that is impossible to describe the whole axon (or some other cable) with only four components of the circuit. We must pay attention to the axon as a series of parts of the electrical circuit is very small- docked together. When a potential difference is applied between the inner and outer sides of the axon, the four currents can be recognized: the axon- side flow, stream- side outside the axon, the current through the resistive component of the membrane, and the membrane capacitive current through the component. Consider Figure 10.8. Electrical circuit that describes a small portion of axons with Δx is shown in the picture. In this small section- side fluid resistance and fluid outer- outer sides respectively are R_o and R_i .

Membrane capacitance and resistance are shown as C_m and R_m . The entire axon is a long series of these subunits are docked together. This is shown in Figure 10.9. The values of the circuit parameters for example wrapped in myelin and axons are not encased in myelin with radius 10.0×10^{-6} m in the list in Table 10.1.

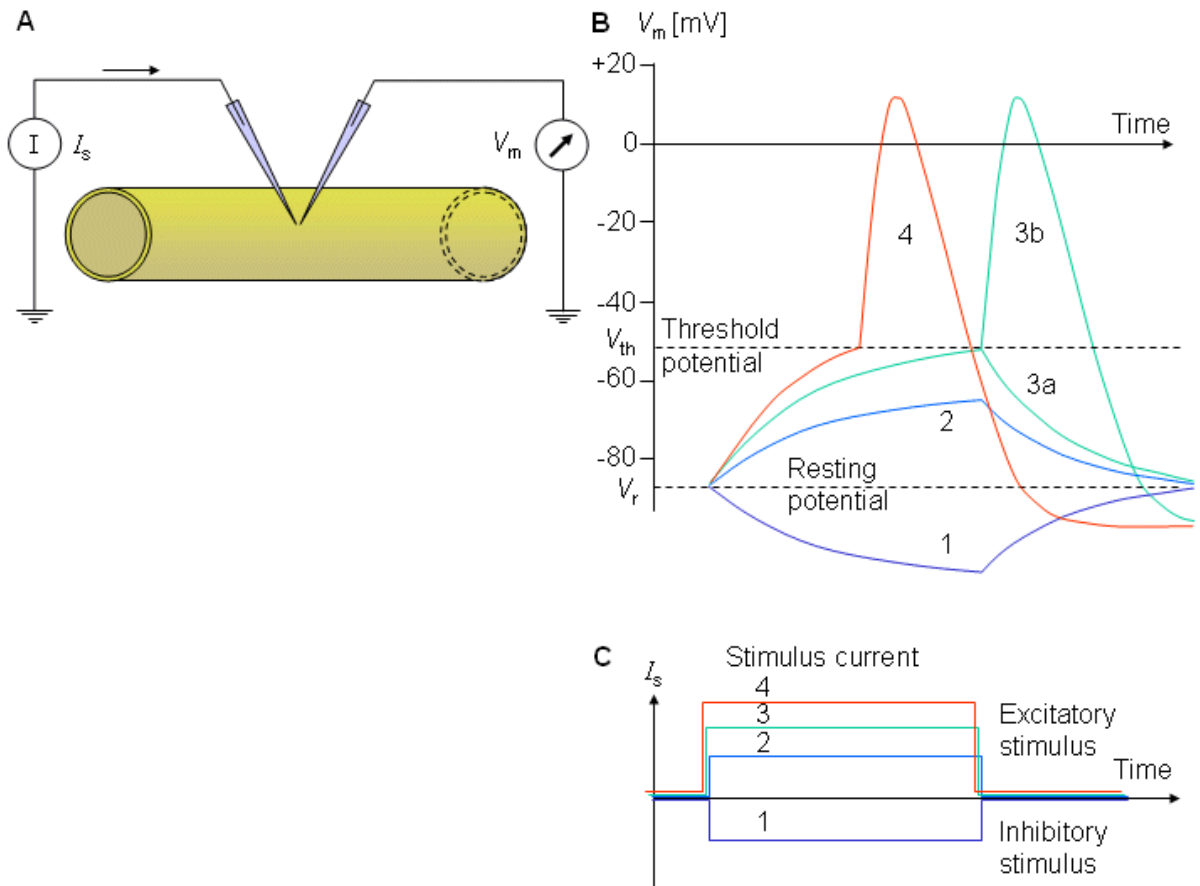

Figure 10.9. Axon is described as an electrical cord.
 (<http://www.bem.fi/book/02/02.htm>).

Performance testing promptly axons showed that the circuit in Figure 10.9 does not explain the most striking characteristic of the axon. Electrical signals propagate along such series at a rate approaching the speed of light (3.0×10^8 m / s), while the pulse propagates along the axon at a rate of about 100 mostly m / s. Furthermore, the circuit in Figure 10.9 melesapkan (eliminate) the electrical signals very quickly, and yet we know that the action potential propagating along the axon without attenuation (weakening). Therefore we must conclude that the electrical signals propagate along the axon is not a simple passive process.

Table 10.1.

The properties of axons example

Properties	Akson are not wrapped myelin	Akson wrapped <i>myelin</i>
The radius of axons	$5,00 \times 10^{-6}$ m	$5,00 \times 10^{-6}$ m

Resistance per unit length of the fluid on the inside and the outside of the axon (R)	$6,37 \times 10^9$ ohm/m	$6,37 \times 10^9$ ohm/m
Conductivity per unit length of the axon membrane (g_m)	$1,25 \times 10^{-4}$ mho/m	$3,00 \times 10^{-7}$ mho/m
Capacitance per unit length of the axon	$3,00 \times 10^{-7}$ F/m	$8,00 \times 10^{-10}$ F/m

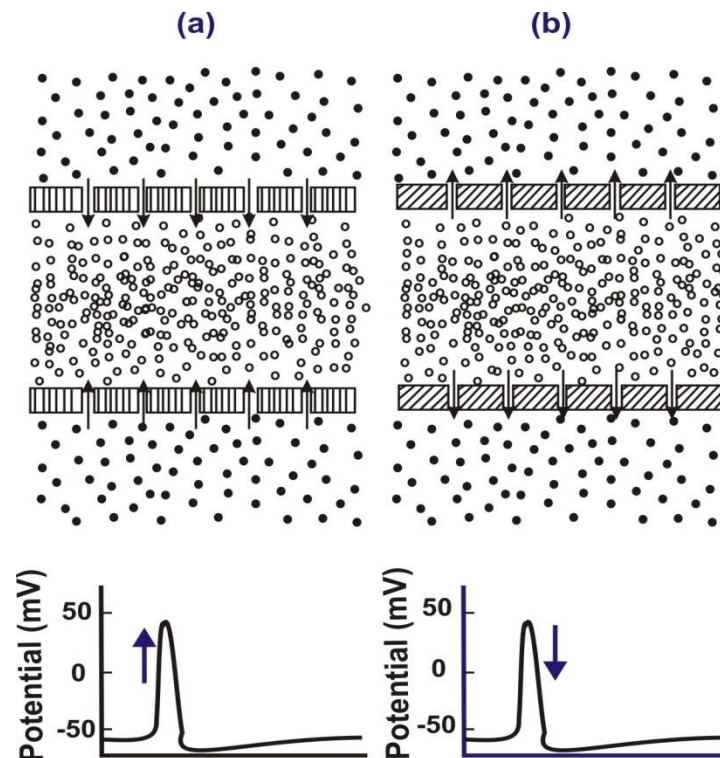

Figure 10.10. Action potential. (a) The action potential began with the axon membrane becomes very permeable to sodium ions (circles filled black) that enters the axon and make it positive. (b) The gates closed sodium and potassium ions (circles not filled black) and make a left axon interior negative again (Davidovits, 2001: 177).

After years of research an impulse propagation along the axon is now known to be rather good. Consider Figure 10.10. As a part of the voltage at the membrane is lowered below a threshold value, the axon membrane permeability to sodium ions increases rapidly. As a result, sodium ions stormed into the axon, eliminate the negative charges and in fact encourage the local potential in the axon becomes positive side. This process resulted in a sharp rise in the beginning of the action potential pulse. Sharp positive spike on the part of the axon increase permeability to sodium immediately in front of it which in turn resulted in a surge in that area. In this way successive interference propagated to the axon, similar to the flames spread to the fuse.

Axon, unlike fuses, renew yourself. At the peak of the action potential axon membrane closes its gates for sodium ions and open the gates for potassium ions. Potassium ions are now storming out, and consequently the potential down the axon to the negative value slightly below the resting potential. After a few milliseconds of potential axon back to the resting state and parts of the axon was ready to accept another pulse.

The number of ions flowing in and out of axons during the pulse was so small that the ion density in the axon has not changed much. The cumulative effect of many pulses offset by metabolic pumps that keep the concentration at the appropriate levels. We can estimate the amount of sodium ions into the axon during the rise phase of the action potential. Inrush of sodium ions alter the amount of electric charge inside the axon. We can express the change in the charge ΔQ capacitor voltage change ΔV in the membrane C, namely:

$$\Delta Q = C\Delta V \quad \dots (10.2)$$

In the resting state, the axon voltage was -70 mV. During the pulse, the voltage changes around +30 mV, resulting in a net change in membrane pressure of 100 mV. We can also estimate the minimum energy required to propagate impulses along the axon. During the propagation of the pulse, the entire axon capacitance emptied in a row and then have to be recharged again. The energy required to recharge the meter axons without myelin is

$$E = \frac{1}{2} C(\Delta V)^2 \quad \dots (10.3)$$

where C is the capacitance per meter axons.

4. Axon circuit analysis

The circuit in Figure 10.9 does not contain the delivery mechanisms of axon pulse. It is possible to incorporate this mechanism into the circuit by connecting a small signal generator along the circuit. But such a circuit is quite complicated. Even the circuit in Figure 10.9 can not be analyzed without calculus. We will simplify the problem by ignoring the axon membrane capacity. The circuit as shown in Figure 10.11 (a). This description applies only when fully charged capacitors so that the capacitive current is zero. With this model we will be able to calculate the voltage attenuation along the cable when given a steady voltage at one end. But this simplified model can not make predictions about the behavior of the time-dependent axon.

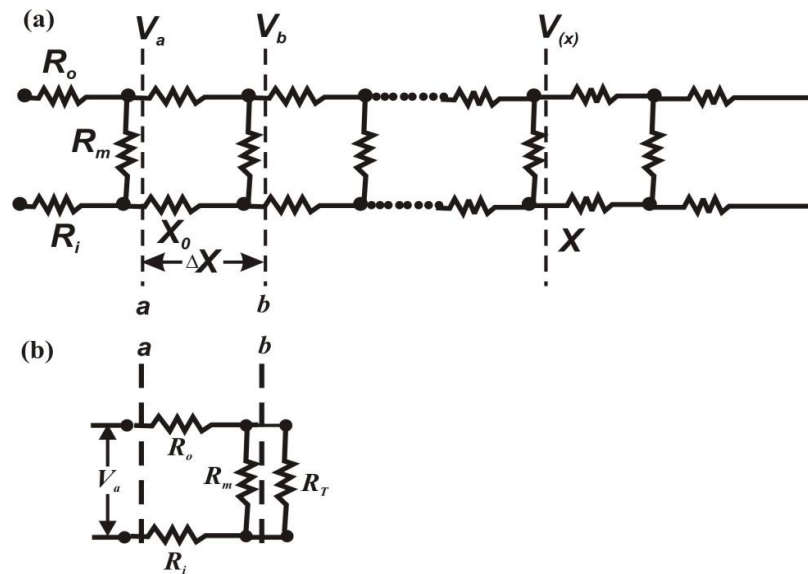

Figure 10.11. (a) Estimates of the circuit in Figure 10.8 with negligible capacitance. (b) Barriers to the right of the line b is replaced with an equivalent barrier \$R_T\$ (Davidovits, 2001: 179).

The problem is to calculate the voltage \$V(x)\$ at point \$x\$ when the voltage \$V_a\$ is given at the point \$x_0\$. Consider Figure 10.11 (a). The approach was to first calculate the voltage drop across a cable section of length \$\Delta x\$ is cut by the line \$a\$ and line \$b\$. We assume that the total cable resistance to the right of the line \$b\$ is \$R_T\$. Therefore, the entire cable on the right line \$b\$ is replaced with \$R_T\$ as shown in Figure 10.11 (b). Because of the infinite cable, any obstacle to the right of the vertical cutting line \$b\$ is equivalent to \$R_T\$ as well. In particular, barriers to the right of a line is \$R_T\$. Therefore, we can calculate the \$R_T\$ by equating the barriers on the right line \$a\$ in Figure 10.11 (b) with \$R_T\$, which is

$$R_T = R_o + R_i + \frac{R_T R_m}{R_T + R_m} \quad \dots (10.4)$$

Measurements showed that the barriers on the inside and the outside of the axon is approximately equal. Therefore, \$R_o = R_i = R\$ and equation (10.4) becomes simpler as

$$R_T = 2R + \frac{R_T R_m}{R_T + R_m} \quad \dots (10.10)$$

Solutions of equation (10.10) yields

$$R_T = R + \left[R^2 + 2R R_m \right]^{1/2} \quad \dots (10.6)$$

Simple circuit analysis shows that

$$V_b = \frac{V_a}{1 + \left[\frac{(2R)(R_T + R_m)}{R_T R_m} \right]} = \frac{V_a}{1 + \beta} \quad \dots (10.7)$$

with β is the amount in brackets.

We can calculate from the measured parameters in Table 10.1. Resistance R and R_m are the values for a small section of length Δx axons. Therefore,

$$R = r\Delta x \quad \text{and} \quad \frac{1}{R_m} = g_m\Delta x \quad \text{or} \quad R_m = \frac{1}{g_m\Delta x}$$

From equation (10.6) it can be shown that if x is very small, then

$$R_T = \left(\frac{2r}{g_m} \right)^{1/2} \quad \dots (10.8)$$

$$\text{and} \quad \beta = (2rg_m)^{1/2} \Delta x = \frac{\Delta x}{\lambda} \quad \dots (10.9)$$

$$\text{with.} \quad \lambda = \left(\frac{1}{2rg_m} \right)^{1/2} \quad \dots (10.10)$$

Now back to the equation (10.8), since Δx is small and can be omitted, β is very small as well. Therefore the rate $1 / (1 + \beta)$ is approximately equal to $(1 - \beta)$. As a result, the voltage V_b at b , within Δx of a , is

$$V_b = V_a \left[1 - \frac{\Delta x}{\lambda} \right] \quad \dots (10.11)$$

To obtain the voltage at a distance x from the line, we divide this distance becomes so $n\Delta x$ increment $\Delta x = x/n$. Then we can apply respectively to the table and obtain the voltage at x as

$$V_b = V_a \left[1 - \frac{\Delta x}{\lambda} \right]^n \quad \dots (10.12)$$

Can be shown that, for small Δx and large n , equation (10.12) can be written as

$$V_b = V_a e^{-x/\lambda} \quad \dots (10.13)$$

Example 10.2:

Based on Table 10.1 calculate λ axons are not encased in myelin.

Completion:

By using equation (10.10) is obtained

$$\lambda = \left(\frac{1}{2rg_m} \right)^{1/2}$$

$$\lambda = \left(\frac{1}{2(6,37 \times 10^9 \text{ ohm/m})(1,25 \times 10^{-4} \text{ ohm/m})} \right)^{1/2}$$

$$\lambda = 8,0 \times 10^{-4} \text{ m} = 0,8 \text{ mm}$$

5. Synaptic Transmission

So far we have noticed propagation of an electrical impulse to the axon. Now we will describe briefly how the pulse was transmitted from the axon to other neuron or muscle cells.

At the far end of the axon branches into nerve endings that stretched into the cells to be activated. Through these nerve endings of axons transmit signals, usually to the number of cells. In some cases the action potential transmitted from the nerve endings to the cells with electrical conduction. Nerve endings are actually not in contact with the cells. There is a gap, the width of approximately 1 nm, between the nerve endings and cell bodies. The area of interaction between the nerve endings and target cells called synapses. Consider Figure 10.12. When the impulse reaches the synapse, a chemical is released at the nerve endings that rapidly diffuses through the gap and stimulate adjacent cells. Chemicals that are released in files with discrete sizes.

Synaptic neurons normally come into contact with many sources. Often the number of synapses must be activated simultaneously to initiate action potentials in the target cell. Action potentials generated by a neuron is always the same size. Neurons work in a variety of: Neurons generate action potentials with a standard size or did not rise at all. In some instances chemicals that are released at synapses stimulated cells but not preclude response to impulses coming along different channels.

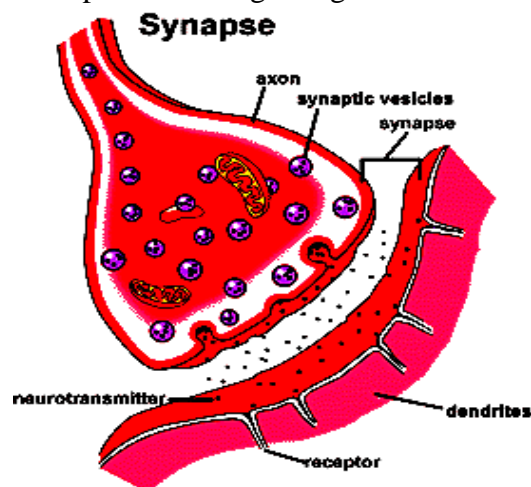

Figure 10.12. Synapses (www.getting-in.com).

6. The muscle action potential

Action potential, the brief (about one-thousandth of a second) reversal of electric polarization of the membrane of a nerve cell (neuron) or muscle cell. In the neuron an action potential produces the nerve impulse, and in the muscle cell it produces the contraction required for all movement. Sometimes called a propagated potential because a wave of excitation is actively transmitted along the nerve or muscle fibre, an action potential is conducted at speeds that range from 1 to 100 metres (3 to 300 feet) per second, depending on the properties of the fibre and its environment.

Muscle fibers generate and propagate impulses in the same way as neurons. Action potential in the muscle fiber initiated by impulses coming from the motor neurons. Before stimulation, a neuron or muscle cell has a slightly negative electric polarization; that is, its interior has a negative charge compared with the extracellular fluid. This polarized state is created by a high concentration of positively charged sodium ions outside the cell and a high concentration of negatively charged chloride ions (as well as a lower concentration of positively charged potassium) inside. The resulting resting potential usually measures about -75 millivolts (mV; 0.0075 volt), the minus sign indicating a negative charge inside. This stimulation causes the potential drop across the membrane fibers that initiate processes involved in the propagation of an ionic pulse. Action potential shape was the same as in neurons except that the duration of time is usually longer. In skeletal muscle, the action potential last approximately 20 ms, whereas in cardiac muscle action potential that could end a quarter of a second.

After the action potential passes through the muscle fibers, the muscle to contract. Details of this process are not yet fully known. In the skeletal muscle fibers, mechanoreceptor organs, called the muscle spindle, forwarding information on the state of muscle contraction. This information is transmitted through neurons for processing and further work. In this way the motion of the muscle is under the control continuously.

In the generation of the action potential, stimulation of the cell by neurotransmitters or by sensory receptor cells partially opens channel-shaped protein molecules in the membrane. Sodium diffuses into the cell, shifting that part of the membrane toward a less-negative polarization. If this local potential reaches a critical state called the threshold potential (measuring about -60 mV), then sodium channels open completely. Sodium floods that part of the cell, which instantly depolarizes to an action potential of about $+55$ mV. Depolarization activates sodium channels in adjacent parts of the membrane, so that the impulse moves along the fibre (<http://www.britannica.com/EBchecked/topic/4491/action-potential>).

If the entry of sodium into the fibre were not balanced by the exit of another ion of positive charge, an action potential could not decline from its peak value and return to the resting potential. The declining phase of the action potential is caused by the closing of sodium channels and the opening of potassium channels, which allows a charge approximately equal to that brought into the cell to leave in the form of potassium ions. Subsequently, protein transport molecules pump sodium ions out of the cell and potassium ions in. This restores the original ion concentrations and readies

the cell for a new action potential. The Nobel Prize for Physiology or Medicine was awarded in 1963 to Sir A.L. Hodgkin, Sir A.F. Huxley, and Sir John Eccles for formulating these ionic mechanisms involved in nerve cell activity.

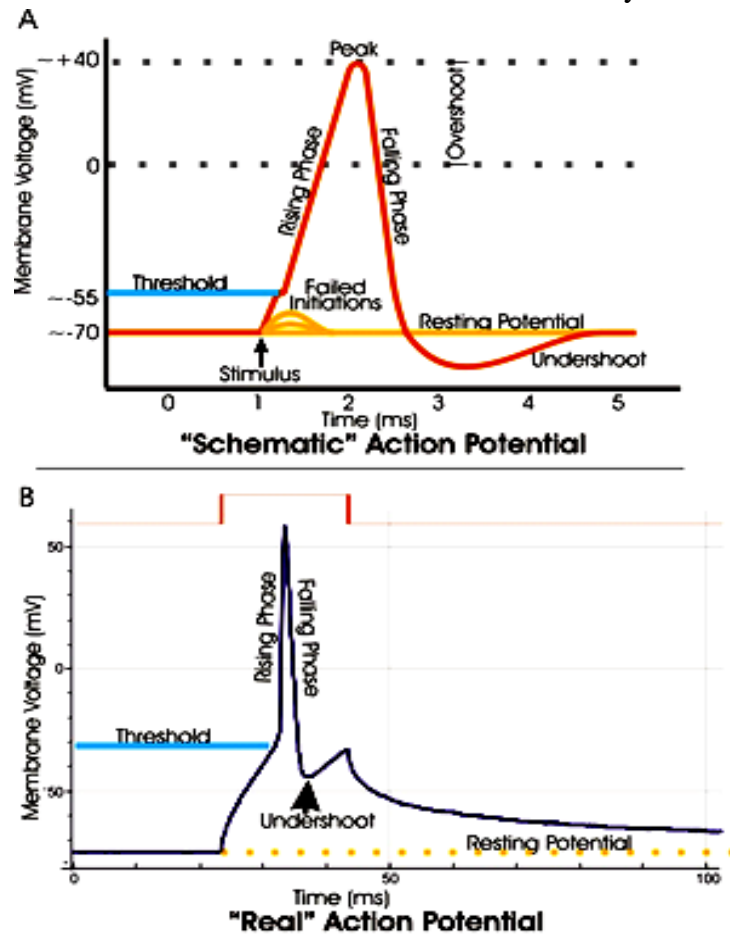

Figure 10.13. **A.** view of an idealized action potential shows its various phases as the action potential passes a point on a cell membrane. **B.** Recordings of action potentials are often distorted compared to the schematic view because of variations in electrophysiological techniques used to make the recording (http://en.wikipedia.org/wiki/Action_potential) cc.

EXERCISE

To improve your understanding of the material above, do the exercises below!

- 1) Calculate the potential of the membrane to Na^+ ions at a temperature of 310K, when the concentration of Na^+ ions in the cell is 110 mol/m³ and outside the cell is 140 mol/m³. Boltzmann's constant $k = 1.38 \times 10^{-23} \text{ J / K}$. K^+ ion charge is $e = 1.60 \times 10^{-19} \text{ C}$!
- 2) Give a brief description of the action potential formation in the cell membrane?

- 3) Provide an explanation of the difference between the function of synapses, axons, and dendrites in a neuron?
- 4) Provide a description of the sodium- potassium pump!
- 5) Explain the advantages nerve segments were wrapped in myelin related to the nature of the insulating myelin!

Instructions to Answer Exercise

If you have difficulty in completing these exercises, consult the instructions for the completion of each of the following questions.

- 1) Consider the example about 10.1.
- 2) Re-read the subject of Bioelectricity generation.
- 3) Read more about the transmission of signals from the neuron cell body to the outside, and a signal from the outside into the cell body of neurons.
- 4) Read carefully about the sodium- potassium pump.
- 5) Read the back of myelin and its function.

RESUME

Bioelectricity is a cellular phenomenon. Electrical potential across the cell membrane occurs due to differences in the concentration of ions inside the cell and outside the cell. The creation of the cell electric potential is related to the diffusion of ions through a semipermeable membrane and Coulomb forces between the ions. Ions are important in creating the cell potentials are ions Na⁺, K⁺, and Cl⁻.

The equation that describes the energy balance between ion concentration gradient and the Coulomb force is shown by the Nernst equation; potential difference inside and outside the cell is expressed as

$$V = V_{\text{in}} - V_{\text{out}} = -2,30 \frac{kT}{Ze} (\log C_{\text{in}} - \log C_{\text{out}})$$

where V is the potential difference (inside minus outside), C_{in} and C_{out} are respectively the ion concentrations inside and outside the cell membrane, k is Boltzmann's constant, T is the absolute temperature, and Ze is the charge on the ion multiplied electron charge (Z is the valence of ion).

Electrical phenomenon that is found in living organisms are highly complex nervous system. Nerve cells are also called neurons form a complex network in the body that receive, process and forward information from one part of the body to other body parts. Center is located in the brain tissue, which has the ability to store and analyze information.

In the axons of neurons there is a potential site of action at the time of cell activity. The process of formation of the action potential can be explained by the

sodium- potassium pump. Axons can also be analyzed as an electrical cord that propagate action potentials.

Changes in electric charge ΔQ in axons because the flow of ions in and out axons to changes in membrane voltage on the capacitor ΔV C, expressed as

$$\Delta Q = C\Delta V$$

E is the energy required to recharge the meter axon is

$$E = \frac{1}{2}C(\Delta V)^2$$

where C is the capacitance per meter axons.

Based on sequence analysis of the axon, the voltage in the axon decreases exponentially. If the steady-state voltage V_a is given at one point on the axon membrane, the voltage V_b at another point within x of that point can be expressed as

$$V_b = V_a e^{-x/\lambda}$$

with

$$\lambda = \left(\frac{1}{2rg_m} \right)^{1/2}$$

r is the resistance per unit length of the fluid inside and outside the axon, gm is the conductivity per unit length of the axon membrane

CHAPTER 11

THE BODY BIOELECTRICITY

The electrical activity of the body has been used for a long time for both diagnostic and monitoring purposes in medicine, largely in connection with the 'excitable' tissues. Examples include ECG, EMG, EEG. More recent developments have begun to look at the tissues which were not regarded as excitable, but in which, endogenous electrical activity has been demonstrated. The endogenous electrical activity of the body arises from a variety of sources, some of which are well documented whilst others remain more obscure in their origins & control mechanisms (Offner 1984, Leonesio and Chen 1987). The relationship between endogenous electrical activity (not exclusively potentials), injury & healing have been researched in several areas of clinical practice.

Action potential in individual cells can be measured by using a very small probe. This is usually done for the purpose of research, such as the investigation of the function of a particular nerve fiber bundle. Measurements were also made for the purpose of treatment. For example, such measurements can assist in determining which nerves are stimulated an artificial eye should have been the most effective. Coordinated electrical activity of the whole cell systems, such as the heart or brain, can also be measured. Large electrical activity that is much more easily observed than the electrical activity of individual cells and consequently also more easily measured. In the course of this study we will discuss about some bioelectricity use in medical diagnosis.

A. Electromyogram

Skin-surface electrodes placed over contracting skeletal muscles will record a complex time-varying biopotential waveform known as an *electromyogram* (EMG). Electromyogram (EMG) signals are generated in muscles, when the muscles contract and a joint is flexed or extended. EMG signals can be measured from a skin surface with noninvasive electrodes, and they include some information on motions such as muscle torque or joint angles. Hence, it is possible to achieve more intuitive human-machine interface using EMG signals than conventional interfaces such as joysticks, data gloves, motion captures. This electric signal arises from the summed action potential events of individual muscle motor units. Because a large number of cells are undergoing action events during muscle contraction, bioelectric current flows are relatively large and can produce skin potentials as high as 10 mV, although more usually it is in the range of a few millivolts.. We will track the transmission of action potentials from the axon to the muscle, causing the muscle to contract. Potential recordings from the muscles during movement called elektromyogram or EMG.

Muscles are composed of many motor units. A motor unit consists of a single neuron branching from the brainstem or spinal cord, and 25 to 2000 muscle fibers (cells) are connected through the motor end plates. The amplitude of the EMG as measured on the skin surface is related, although not linearly, to muscle contraction force. In general, an increasing frequency and complexity of the myogram biopotential follows increasing

muscular contraction. This results from both the increased motor unit firing rate and the increased recruitment of muscle fibrils.

The EMG waveform looks random and is fairly well represented by random noise having a Gaussian distribution function. The peak energy is roughly in the 30- to 150-Hz range with some low-energy components as high as 500 Hz. As the muscle fatigues, the EMG frequency spectrum shifts toward the lower frequencies, and the bioelectric amplitude decreases. Many attempts have been made to use the skin-surface-detected EMG as an indicator of the strength of voluntary muscle force generation, but with often less than hoped-for success.

The biopotential frequency and amplitude tend to change little over a range of low contractile force, rise quickly with small changes in moderate force, and vary relatively little with progressively larger forces. In applications where the EMG is used for control of prosthetics, there have been problems due to a relatively little range of proportional control. Even so, the EMG is widely monitored and used for many applications in research and medicine partly because it is so accessible and easily recorded.

For example, the EMG is often used in biomechanics research where it is desired to monitor which muscle groups are active and/or their timing and sequence of contraction. Frequency-spectrum analysis of the EMG can be used to detect the degree of muscle fatigue and to gain insight into muscle performance. EMG monitoring of jaw and neck muscle tension is employed in commercial biofeedback monitors designed to encourage relaxation. Biopotential amplifiers used for EMG monitoring are fairly simple since standard instrumentation amplifiers or even inexpensive operational amplifiers can be used in a differential mode. An electrode placement and differential amplifier setup used to measure the EMG is shown in Fig 11.1. Downloaded from Digital Engineering Library @ McGraw-Hill (www.digitalengineeringlibrary.com)

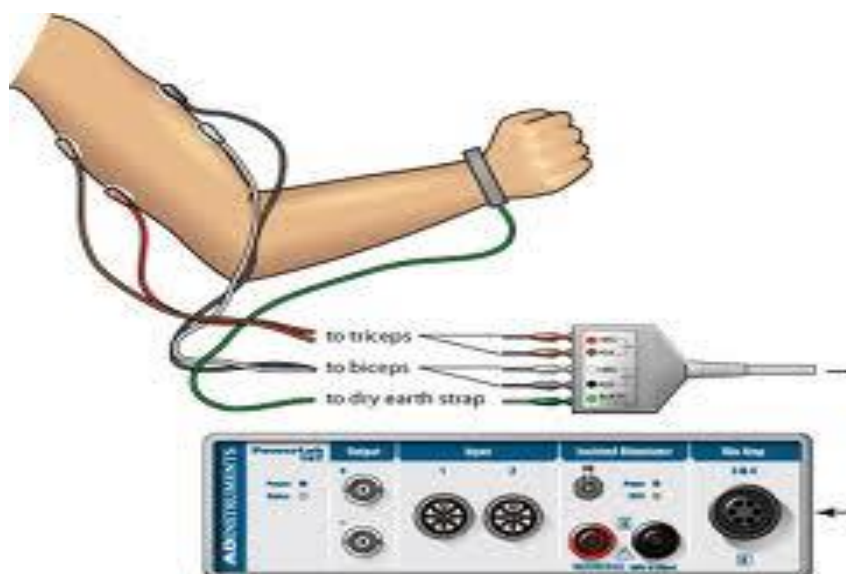

Figure 11.1. Detection of the EMG by skin electrodes.

Single muscle cells are usually not monitored in an EMG because it is difficult to isolate a single muscle. EMG electrodes usually record the electrical activity of a number of fibers. Typically an electrode surface or concentric needle electrode. A surface electrodes attached to the skin to measure electrical signals from many motor units. A concentric needle electrode inserted under the skin to measure the activity of a single motor unit with insulated wires connected by edges. Figure 11.2 shows a typical EMG electrodes were of two types.

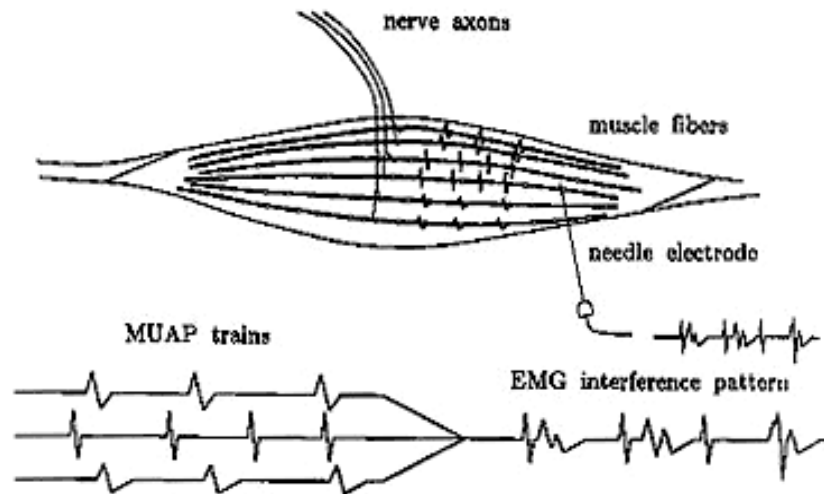

Figure 11.2. Electromyogram obtained with a concentric needle electrode and an electrode surface(<http://www.backtohealthonline.com/emg.html>).

Typical arrangement for recording EMG is shown in Figure 11.3. Muscle electrical signals can ditunjukkan directly on one channel oscilloscope, and the signals can be combined and shown on the second line. The signals can also be passed to the amplifier and speaker can be heard. Integrated recording (in volts second) is a measure of the amount of electricity that is associated with muscle action potentials. Figure 11.4 shows the EMG and its integrated form for the levels of different voluntary muscle contraction. The stronger the greater the contraction action potential activity. Evaluating the integrated form of action potential activity is easier because the shape of the curve is much smoother. In the clinic EMG can be heard and integrated forms are often used to determine the condition of the muscle during contraction.

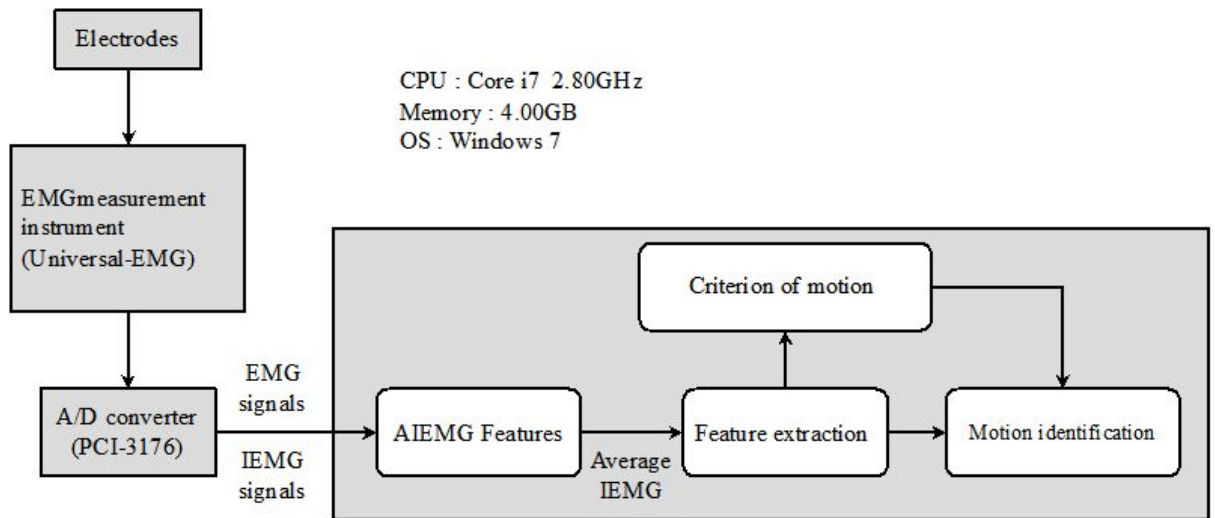

Figure 11.3. The arrangement of instruments to obtain EMG.
 (http://www.intechopen.com/source/html/40118/media/image1_w.jpg).

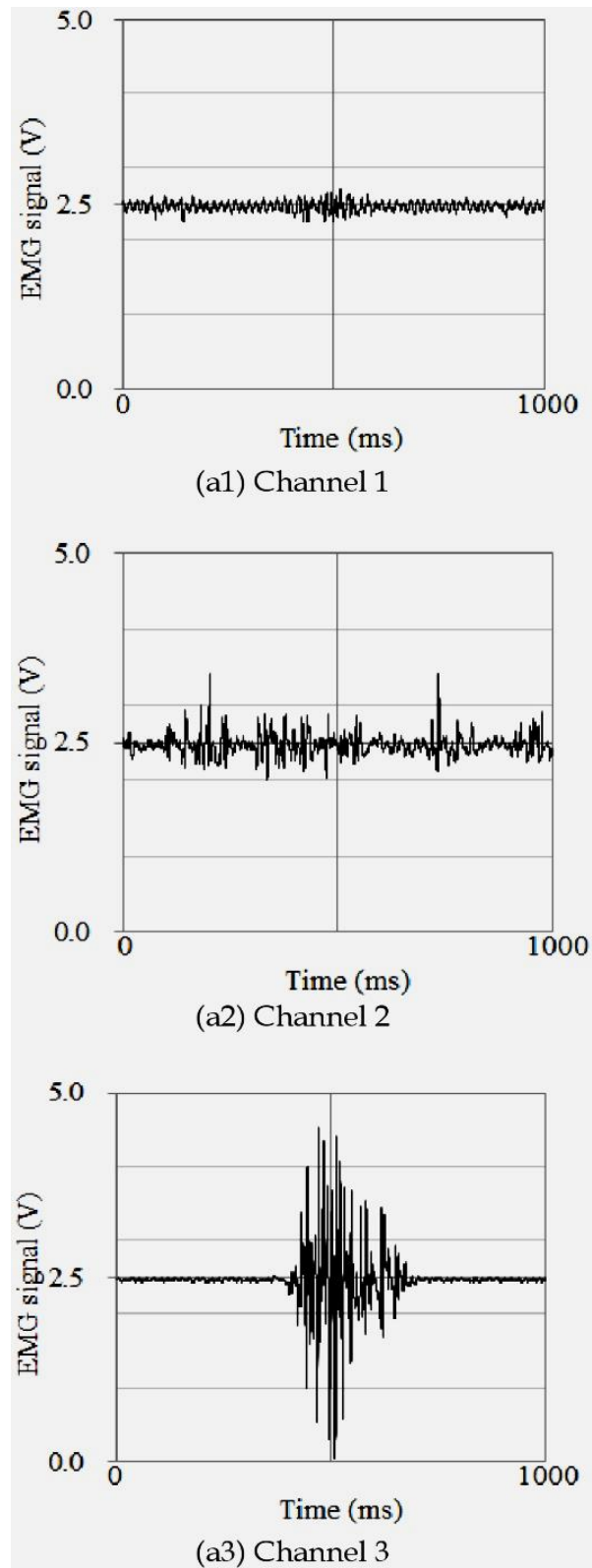

Figure 11.4. Electromyogram for (a1) shows the minimal contraction of motor unit action potentials of single and (a2) shows the maximum contraction of the action potential motor units (http://www.intechopen.com/source/html/40118/media/image1_w.jpg)

EMG can be obtained from the muscles or motor units are stimulated electrically, and this method is often preferred over voluntary contraction. Voluntary contraction is usually spread at approximately 100 ms for all motor units are not aroused at the same time; motor unit can also produce some of the action potential depends on the signals transmitted from the central nervous system. With electrical stimulation, stimulation time is determined by the well and all the muscle fibers was awakened at about the same time. A typical pulse stimulation can have s] the amplitude of 100 V and ends 0.1 to 0.5 ms.

An EMG obtained during electrical stimulation of the motor unit is shown in Figure 11.5. EMG action potential appears in the following period of hidden or latent period (time between stimulus and response starts there). Sometimes EMG of the muscles of the body symmetrically compared with each other or against the ordinary individual muscles to determine whether action potentials or latent periods are similar or not.

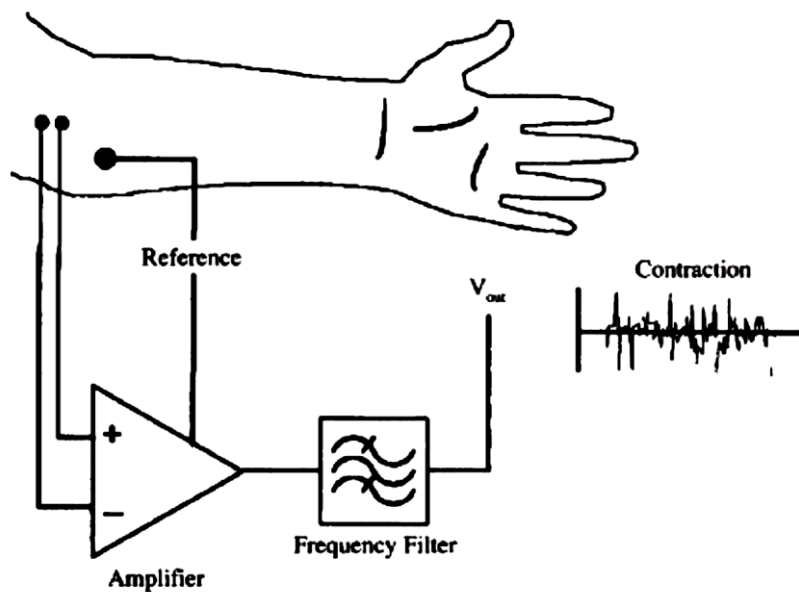

Figure 11.5. The arrangement of instruments to obtain EMG during electrical stimulation of the motor unit (www.digitalengineeringlibrary.com).

In addition to electrical stimulation of the motor unit, it is possible to stimulate the sensory nerves that carry information to the central nervous system. The EMG signals are measured with bipolar surface electrodes consisting of two parallel silver bars. These signals are amplified and converted into IEMG signals with rectification smoothing (the cutoff frequency 2.4 Hz) by means of a differential amplifier (Universal-EMG, Oisaka development Ltd.). The EMG signals are sampled at 10 kHz through a 16-bit A/D converter (PCI-3176, Interface Co.) and taken in a data-collection computer.

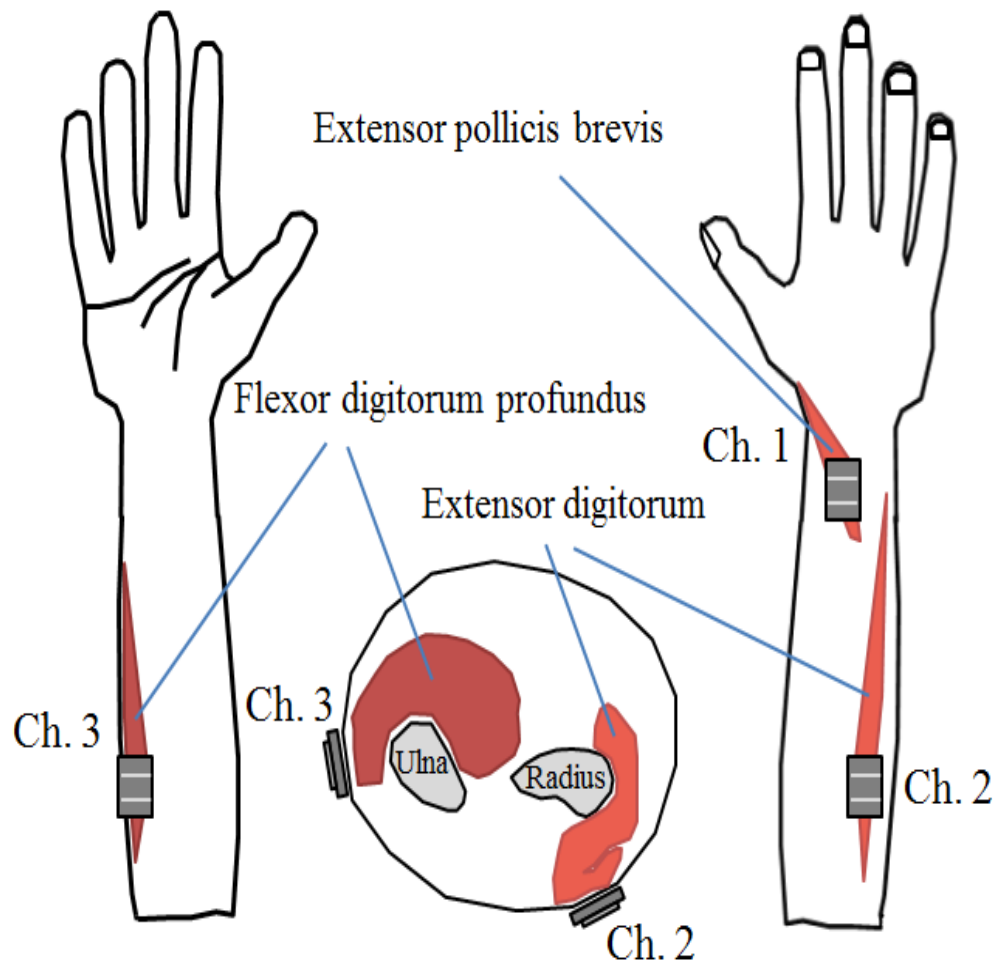

Figure 11.6. Measured muscles and electrodes placed on forearm
(http://www.intechopen.com/source/html/40118/media/image1_w.jpg)

A nerve conduction study (NCS) is a test commonly used to evaluate the function, especially the ability of electrical conduction, of the motor and sensory nerves of the human body. Nerve conduction velocity (NCV) is a common measurement made during this test. A nerve conduction velocity test measures how quickly electrical impulses move along a nerve. It is often done at the same time as an EMG, see: www.ebme.co.uk/arts/emg/

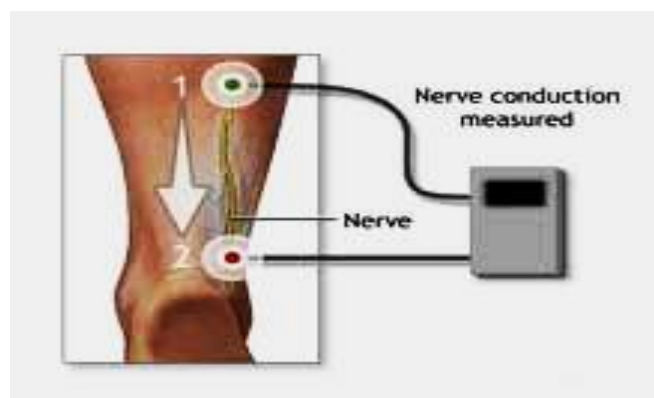

Figure 11.7. Nerve Conduction measured (<http://www.ebme.co.uk/articles/clinical-engineering/68-nerve-conduction-velocity-ncv-test>)

In order to exclude or detect muscle disorders. A healthy nerve conducts signals with greater speed and strength than a damaged nerve. The speed of nerve conduction is influenced by the myelin sheath - the insulating coating that surrounds the nerve. Most neuropathies are caused by damage to the nerve's axon rather than damage to the myelin sheath surrounding the nerve. The nerve conduction velocity test is used to distinguish between true nerve disorders (such as Charcot-Marie-Tooth disease - also known as hereditary motor and sensory neuropathy (HMSN)) and conditions where muscles are affected by nerve injury (such as carpal tunnel syndrome). This test is used to diagnose nerve damage or dysfunction and confirm a particular diagnosis. It can usually differentiate injury to the nerve fibre (axon) from injury to the myelin sheath surrounding the nerve, which is useful in diagnostic and therapeutic strategies. During the test, flat electrodes are placed on the skin at intervals over the nerve that is being examined. A low intensity electric current is introduced to stimulate the nerves thus generating nerve impulses.

The nerve impulse is a wave of cell depolarisation immediately followed by a wave of repolarisation, collectively called an action potential, occurring on the plasma membrane of a nerve fibre. Changes in ion conductances across the nerve fibre membrane are responsible for the initiation and propagation of the action potential. Experimentally, these changes can be the result of electrical current applied through electrodes. Once initiated, an action potential is usually propagated without decrement in amplitude or velocity along the plasma membrane of a nerve fibre.

The velocity or speed of the propagated (conducted) nerve impulse is directly related to the diameter of the nerve fibre and the presence of a myelin sheath. The fastest nerve fibres have large diameters and are myelinated; for example, the motor nerve fibres that supply skeletal muscles. The slowest nerve fibres have small diameters and are unmyelinated; for example, sensory nerve fibre from the stomach.

In the peripheral nervous system, nerve fibres of various diameters and functions (motor and sensory) are bundled together by connective tissue to form nerves. A compound action potential is the sum of all the action potentials occurring in the individual neurons of the whole nerve. The velocity of the compound action potential signal can be a measure and can indicate the state of health of the nerve. Diseases that damage the myelin, destroy neurons, or constrict the whole nerve will decrease the nerve's conduction velocity. However, the nerve conduction velocity may remain normal until late in a disease process as long as a few normal neurons survive. In addition, the nerve conduction velocity reflects conduction of the fastest nerve fibres, usually motor neurons.

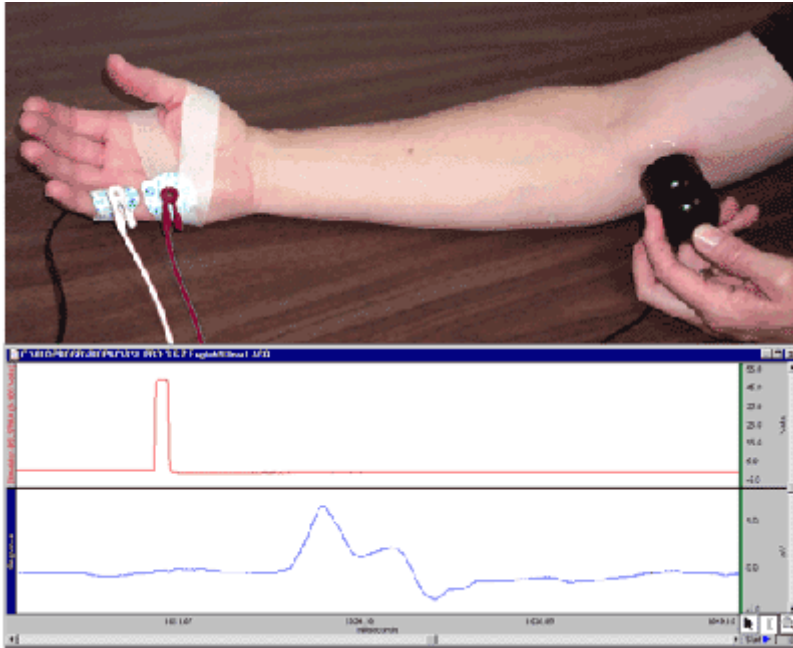

Figure 11.8. The nerve conduction velocity is determined by recording the motor response of a muscle (<http://www.ebme.co.uk/articles/clinical-engineering/68-nerve-conduction-velocity-ncv-test>)

The nerve conduction velocity is determined by recording the motor response of a muscle to the stimulation of its motor nerve at two or more points along the nerve course. The time between stimulation and response is measured and compared to the distance between the point of stimulation and point of response. The velocity at which the resulting electric impulses are transmitted through the nerves is determined when images of the impulses are projected on an oscilloscope or computer screen. If a response is much slower than normal, damage to the myelin sheath is implied. If the nerve's response to stimulation by the current is decreased but with a relatively normal speed of conduction, damage to the nerve axon is implied. The nerve is stimulated, usually with surface electrodes, which are patch-like electrodes (similar to those used for ECG) placed on the skin over the nerve at various locations. One electrode stimulates the nerve with a very mild electrical impulse. The resulting electrical activity is recorded by the other electrodes. The distance between electrodes and the time it takes for electrical impulses to travel between electrodes are used to calculate the nerve conduction velocity. Normal body temperature must be maintained (low body temperature slows nerve conduction). There is generally minimal discomfort with the test because the electrical stimulus is small and usually is minimally felt by the patient. Often the nerve conduction test is followed by electromyography (EMG) which involves needles being placed into the muscle and you contracting that muscle. This can be uncomfortable during the test, and you may feel muscle soreness at the site of the needles afterwards as well.

The interpretation of nerve conduction studies is complex, but in general, different pathological processes result in changes in latencies, motor and/or sensory amplitudes, or slowing of the conduction velocities to differing degrees. For example, slowing of the NCV usually indicates there is damage to the myelin. Another example, slowing across the

wrist for the motor and sensory latencies of the median nerve indicates focal compression of the median nerve at the wrist, called carpal tunnel syndrome. On the other hand, slowing of all nerve conduction in more than one limb indicates generalized sick nerves, or generalized peripheral neuropathy. People with diabetes mellitus often develop generalized peripheral neuropathy (<http://www.ebme.co.uk/articles/clinical-engineering/68-nerve-conduction-velocity-ncv-test>).

B. Electrocardiogram

In the course of a previous study we have studied the heart as a double pump. Heart has four chambers, as shown in Figure 11.9: two upper chamber, the left atrium and the right atrium, aligned to contract simultaneously as two lower chamber, the left ventricle and the right ventricle. Right atrium receives venous blood from the body and pumps it into the right ventricle. The right ventricle pumps blood through the lungs, where the blood get oxygen. Then the blood flows into the left atrium. Contraction of the left atrium the blood moves to the left ventricle, which contracts and pumps blood into the general circulation; blood passes through the capillaries into the venous system and back into the right atrium,

Working heart rhythm is controlled by an electrical signal that is initiated by stimulation of spontaneous specialized muscle cells that are in the right atrium. These cells compose the SA node (sinoatrial), or hyper motion (pacemaker); note Figure 11.9. SA node pulsed at regular intervals of approximately 72 times per minute; however, the pulse rate can be raised or lowered by or external cardiac nerves that respond to the demands of the body's blood and other stimuli. Electrical signals from the SA node depolarization initiated nerves and muscles of the second platform, causing the porch to contract and pump blood into the chambers. Repolarization followed porch. Then the electrical signals that pass into the AV node (atrioventricular), which initiate depolarization right ventricle and left ventricle, causing it to contract and push blood into the pulmonary circulation and general circulation. Then the nerves and muscles of runs booth experience repolarization and start again.

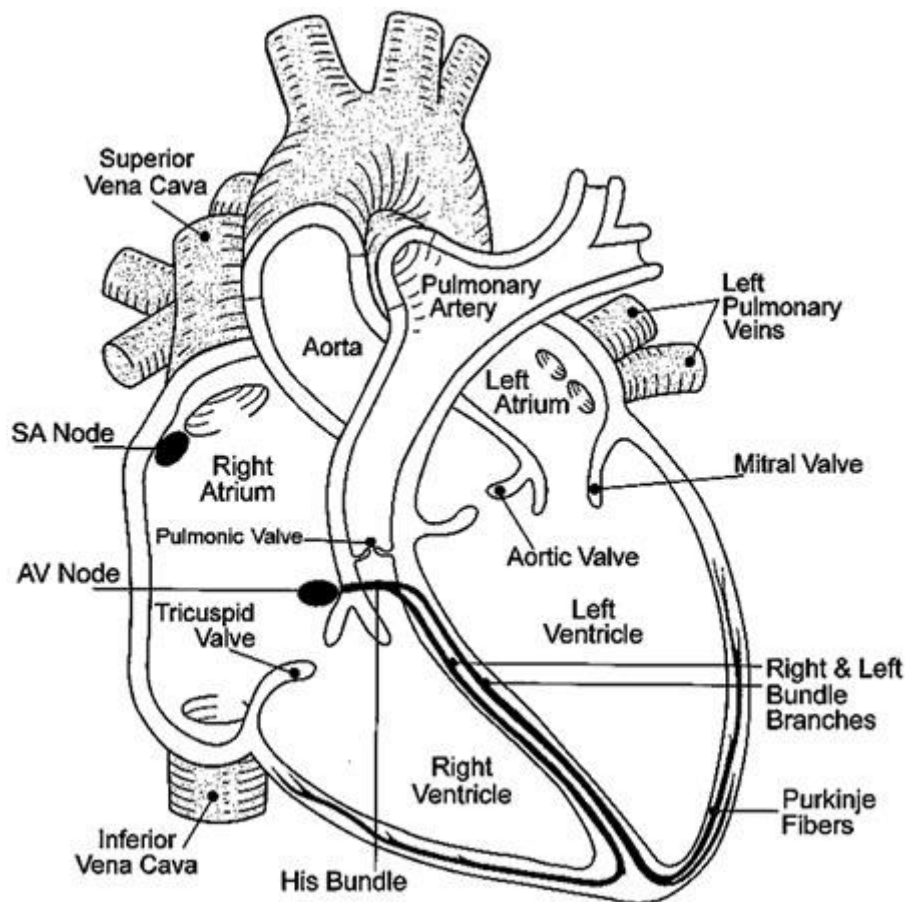

Figure 11.9. Human heart. Note the sinoatrial node, or pacemaker motion, and atrioventricular, ventricular contraction that started ([/wiki.engr.illinois.edu](http://wiki.engr.illinois.edu)).

The nerves and muscles of the heart can be seen as a source of electricity that is enclosed in a conductor, torso. Obviously not practical to perform electrical measurements directly on the heart; diagnostic information is obtained by measuring the electrical potentials generated by the heart in various places on the body surface. Potential recordings in the heart of the skin is called the electrocardiogram.

The relationship between the working heart pumping and electric potentials on the skin can be understood by observing the propagation of an action potential in the heart wall as in Figure 11.10. Current flow in the torso carries the potential drop as shown in the chart on the resistor. Potential distribution for all the chambers of the heart when polarized half indicated by equipotential lines in Figure 11.11. Note that the potentials measured on the surface of the body depends on the location of the electrode.

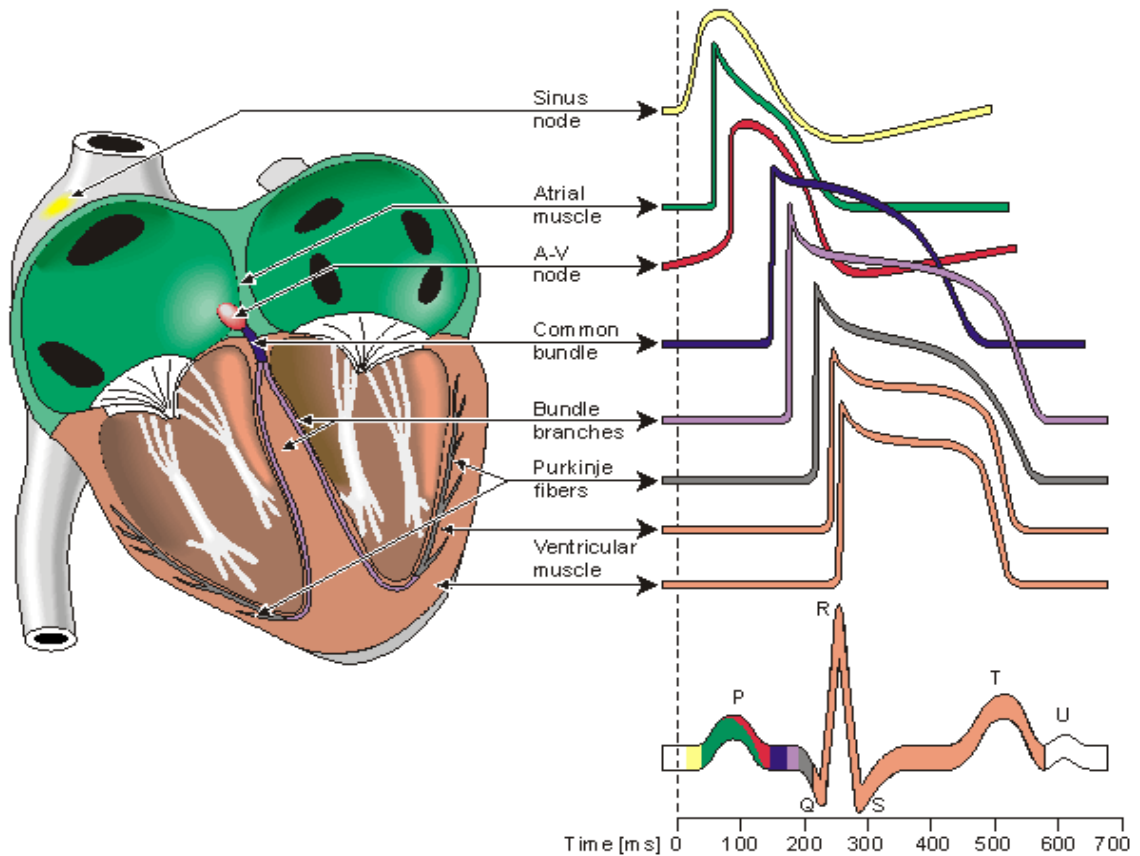

Figure 11.10. Schematic action potential that moves the heart wall. Some of the ion current is shown by the circles, passed torso, indicated by resistor. Potential on the chest wall caused by the current flow through the barrier torso (www.bem.fi).

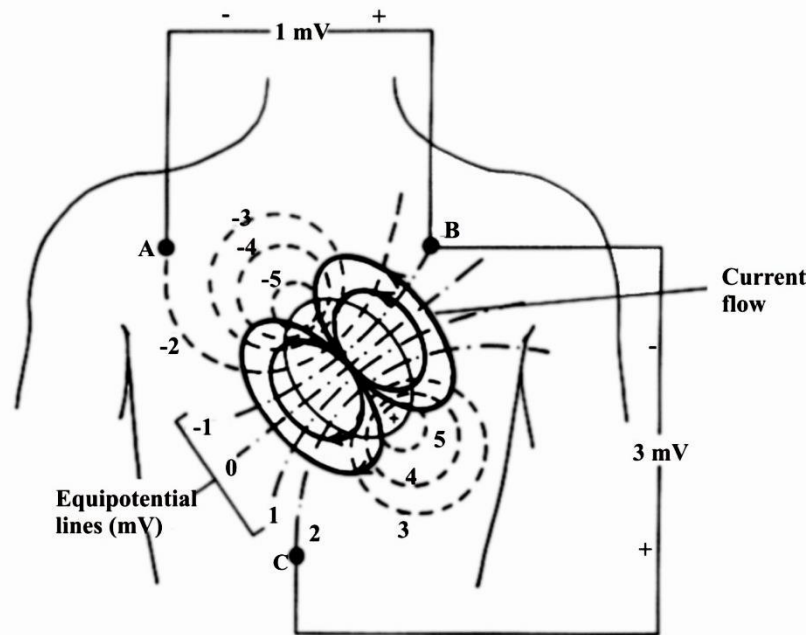

Figure 11.11. Potential distribution on the chest at the time of the ventricles depolarized half. Electrodes located on the A, B, and C will show the potentials at the time. (Cameron, 1978: 199).

Shape of the potential lines are shown in Figure 11.11 is almost equal to the potential lines obtained from an electric dipole. It will be recalled that the electric dipole is generated when a positive charge and a negative charge are separated from each other and the electric dipole can be described by a vector. Equipotential lines at other times in the cardiac cycle can also be described by the electric dipoles; however, dipole- dipole for different times in the cycle will be different size and direction. Electric dipole model of the heart was first put forward by AC Walter in 1889 and has been modified several times by other experts.

Electric potential (heart) that we measured on the body surface is only a projection of the electric dipole moment of the vector in a particular direction. Because the vector change with time, the projected potential is also changed with time. Figure 11.12 shows an electric dipole field along with three electrocardiographic body.

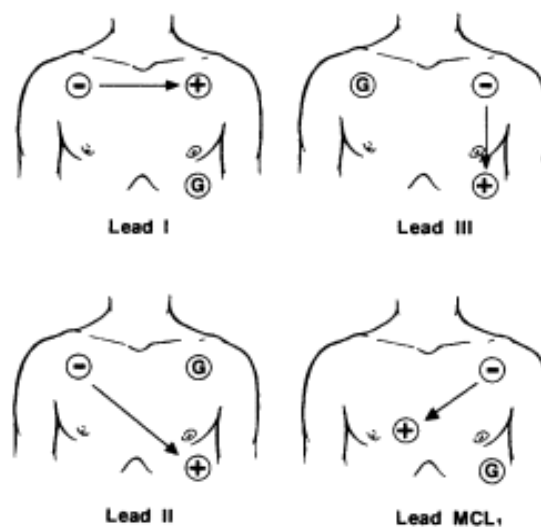

Figure 11.12. Electrocardiographic fields and an electric dipole vector. RA, LA, RL, and LL indicate places electrodes on the arm and left leg and right (rtboardreview.com).

Surface electrodes to obtain the most common ECG placed on the left arm (LA), right arm (RA) and left leg (LL), although the location of the electrode - lektrode it may vary in different clinical situations; sometimes hand or position which is close to the heart are used. Potential measurements between LA and RA are called Lead I, between RA and LL called Lead II, between LA and LL called Lead III (Figure 11.13). This configuration was pioneered by Willem Einthoven, Dutch physiologist, and the three leads is called the standard limb leads. Three raw lead is commonly used in clinical examination all. Potential between the two leads give the relative amplitude and direction of the electric dipole vector in front of the field (Figure 11.14).

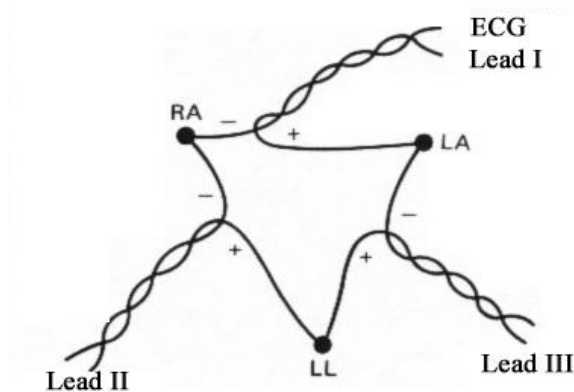

Figure 11.13. Electrical connection for Lead I, Lead II, and Lead III. The polarity of the recording instrument, it is shown for each Lead.(Cameron, 1978: 201).

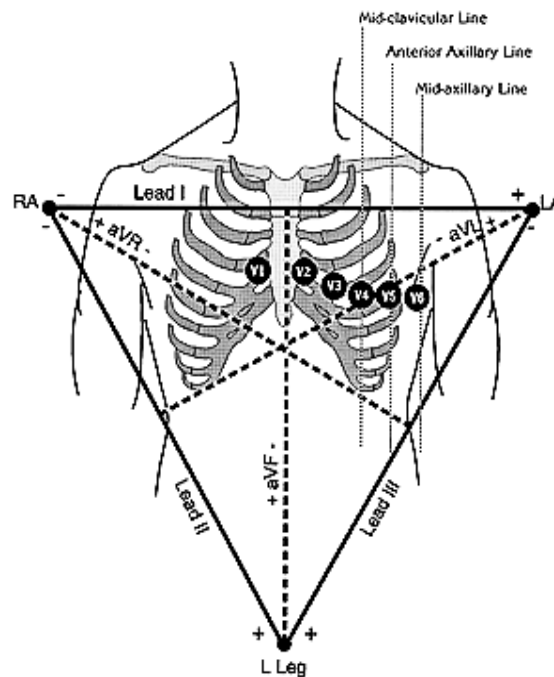

Figure 11.14. Chart cardiac electrical dipole projected on the front. Three electrodes (RA, LA, and LL) can be thought of as points angle triangle, triangle Eintoven. Potential Lead I in a time proportional to the dipole vector projected on the line RA - LA; potential in Lead II and Lead III potential is proportional to the projections on the other sides of the triangle (Cameron, 1978: 201).

Enlarged configuration leads, aVR, aVL, and aVF, also obtained in the next field. To lead aVR, the recorder is connected to the RA side and the other side is connected to the center of the two resistors connected to the LL and LA (Figure 5:27). Enlarged two leads are obtained in a similar way: for lead aVL, the recording electrode attached to the LA and

the resistors connected to the RA and LL; to lead AVF, the recording electrode attached to the LL and resistors connected to the RA and LA.

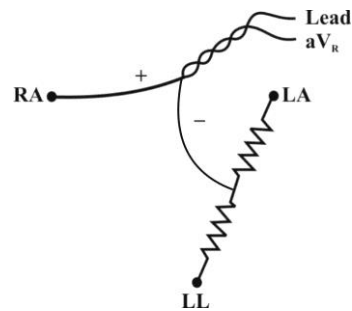

Figure 11.15. Lead enlarged obtained by placing a pair of resistors between the two electrodes. Center resistor pair was used as one electrode connections and the rest is used as a second relationship. Arrangement shown in Fig leads aVR enlarged (Cameron, 1978: 202).

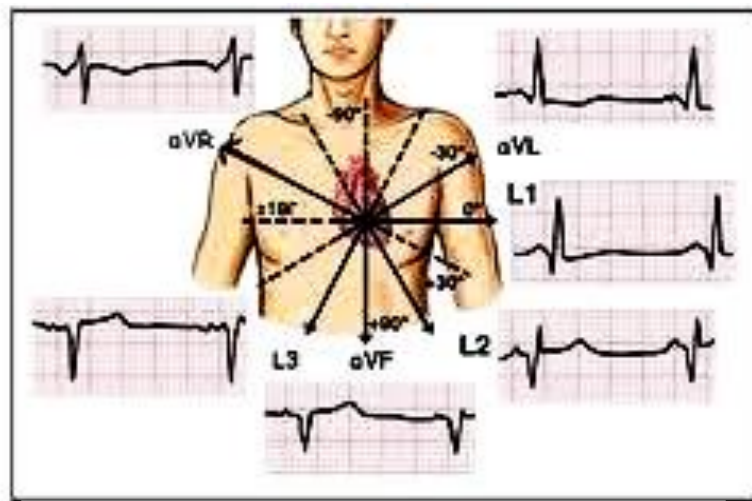

Figure 11.16. Typical ECG Lead II position. P represent depolarization and contraction porch, QRS showed depolarization booths, cubicles contraction occurs between S and T, and T describe repolarization booth. (Cameron, 1978: 202).

Each tracker ECG mapping the electric dipole vector projection, or the electrical activity of the heart, through every part of the cycle. Figure 11.16 shows the schematic output Lead II with standard symbols for parts of the pattern. The events of the main power to the normal cardiac cycle are (1) that produces depolarization porch P wave, (2) repolarization portico rarely seen and not labeled, (3) chamber that produces depolarization QRS complex, (4) repolarization booths that produce T wave, consider Figure 11.16.

Figure 11.17 shows the six ECG field next to normal people. Note that in some cases the waveform is positive and in other cases the waveform is negative; sign depends on the

shape of the wave vector direction and the electric dipole polarity and electrode position measuring instrument.

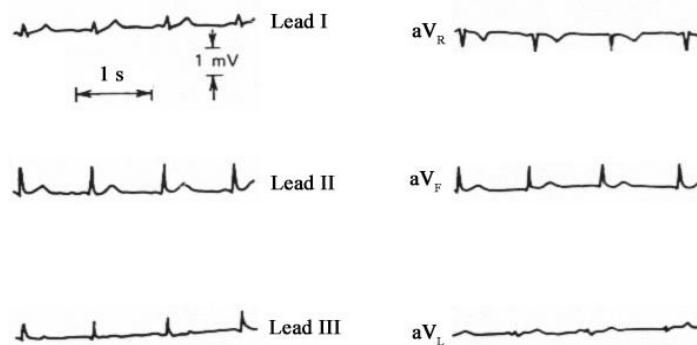

Figure 11.17. Six ECG field next to the normal (Cameron, 1978: 203).

In clinical examination, ECG six transverse field is usually made in addition to the six ECG front field. For measurements of the transverse field the negative end is attached to the electrode ECG recorder free at the center which is connected to three resistors RA, LL, and LA in Figure 11.18 (a), and the other electrode is moved to the chest wall to six different positions are shown in Figure 11.18. Figure 11.19 shows a typical ECG transverse field.

ECG is usually interpreted by a cardiologist, who can quickly determine whether the patterns of normal and whether aritmik. However, the computer can also be used to analyze ECG. In the ICU (Intensive Care Unit) and during surgery usually ECG was monitored continuously and was shown on the screen CRT oscilloscope. ECG showed disturbances in the normal electrical activity of the heart. For example, the ECG may give hint of taknormal state known as heart block. If the signal is normal SA node is not delivered into the chamber, then the pulse will control the rate of AV - heart at a frequency of 30 to 50 beats/min, which is much lower than normal (70 to 80 beats a minute). Such a heart blockage can make a semi - handicapped patients, the pacemaker was implanted allow patients to live like a normal person.

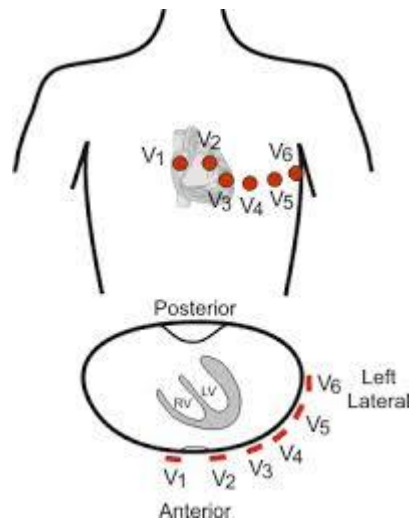

Figure 11.18. ECG positions transverse field (wikis.engrade.com).

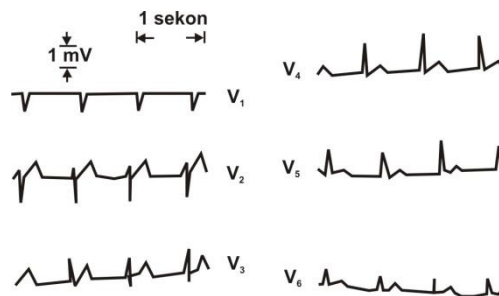

Figure 11.19. Six ECG transverse field for a normal human.(Cameron, 1978: 204).

C. Electroencephalogram

If the electrodes placed on the scalp and the electrical activity is measured, it will obtain some complex electrical signals are weak. These signals are mainly due to the electrical activity of neurons in the cerebral cortex. These signals were first observed by Hans Berger 1929; since then many studies on the application of clinical, physiological, psychological of these signals, but a basic understanding is still lacking. One hypothesis states that the potentials generated by the synchronization process involving dotted neurons in the cortex, with different groups of neurons become tersinkroni - SASI at different times. According to this hypothesis these signals consist of segments of the electrical activity of short successive groups of neurons located at various places in the cortex.

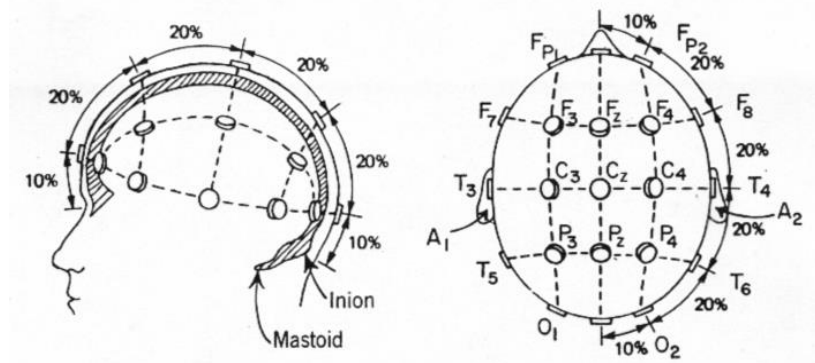

Figure 11.20. 10-20 international system where the raw EEG. Lettered electrodes are placed at intervals of 10 % and 20 % of the distance between specific points on the skull. Protuberans inion is reinforced on the lower back of the skull and mastoid behind the ear is protuberans (Cameron, 1978: 205).

Recording the electrical signals of the brain called the electroencephalogram (EEG). Electrodes for recording signals is often a small silver disc - cakaram berklorida. The electrodes are attached to the head in places depending on the part of the brain studied. Figure 11.20 shows the standard international 10-20 system of electrode place, and Figure 11.21 shows a typical EEG for several pairs of electrodes. Reference electrode is usually attached to the ear (A1 or A2 in Figure 11.20). In routine examinations, 8 to 16 channels simultaneously recorded. Because the activity is often an indication of asymmetric brain disease, right- sided signals are often compared to the left side signals.

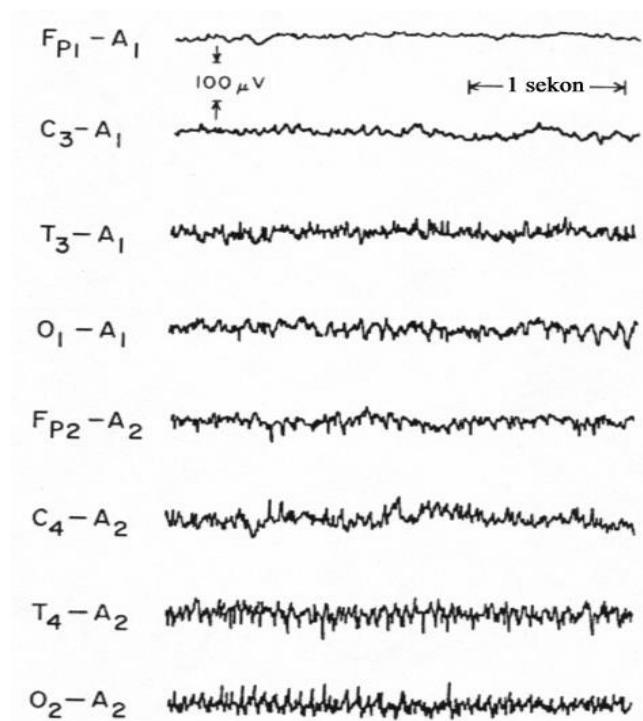

Figure 11.21. Normal EEG. See Figure 11.20 to place electrodes. Reference electrode connected to the ear (A1 or A2) (Cameron, 1978: 206).

EEG signal amplitude is low (about $50 \mu\text{V}$), and interference from external electrical signals often cause serious problems in the EEG signal processing. Although the noise (noise) externally controlled, potentials of muscle activity such as eye movements can cause interference on the recording.

EEG frequencies seem to depend on a person's mental activity. For example, people are relaxed usually have an EEG signal that mainly consists of frequencies from 8 to 13 Hz, or alpha waves. When people are more alert higher frequency range, the beta wave range (above 13 Hz), EEG signals dominate. Several frequency bands are as follows.

Delta (δ), or slowly	0.5 to 3.5 Hz
Theta (θ), or mid slow	4 to 7 Hz
Alpha (α),	8 to 13 Hz
Beta (β), or rapid	greater than 13 Hz

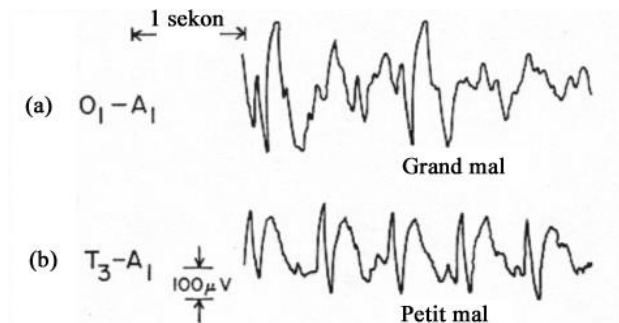

Figure 11.22. Electroencephalogram for two types of epilepsy: (a) grand mal and (b) petit mal. (Cameron, 1978: 207).

EEG is used as a tool for diagnosis of diseases involving the brain. EEG is most useful in the diagnosis of epilepsy and allow classification of epileptic seizures. EEG for severe epileptic attacks with loss of consciousness, called a grand mal attack, showed a rapid surge of high voltage in all leads from the skull. Consider Figure 11.22 (a). EEG for less severe attacks, called petit mal attacks, showed rounded to 3 waves per second, followed or preceded by rapid jumps, as in Figure 11.22 (b). EEG helps in confirming brain tumors because of reduced electrical activity in the tumor area. More quantitative method to determine the location of brain tumors involving x-rays or nuclear medicine techniques. EEG is used as a monitor in the surgery when the ECG can not be used. EEG is also useful in surgical patients to indicate the level of anesthesia. During surgery is usually a single channel to be monitored.

Many studies involving observation of sleep EEG patterns for different levels of sleep, as shown in Figure 11.23. As long as people become sleepy, specifically with his eyes closed, the frequencies of 8 to 13 (alpha waves) dominate the EEG. The amplitude increases and decreases during the switching frequency of sleep " chicken " (sleep onset) to sleep soundly. Sometimes taken for sleep EEG showed a high frequency pattern called paradoxical sleep or rapid eye movement (REM) because the eyes move during this period. Apparently paradoxical sleep associated with dreams.

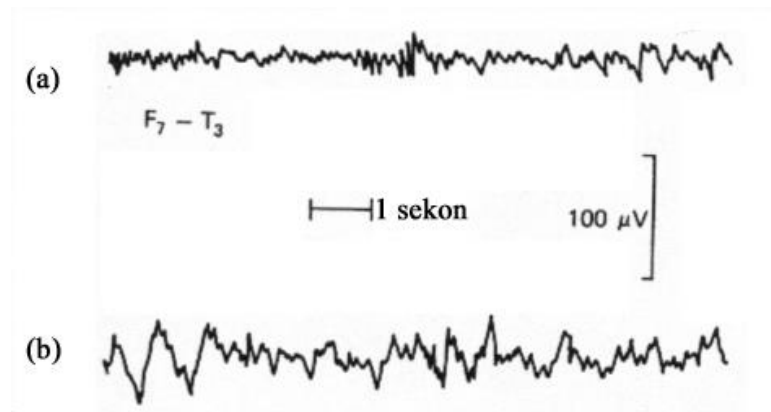

Figure 11.23. Electroencephalogram for two levels of sleep: (a) sleep onset and (b) deep sleep (Cameron, 1978: 207).

In addition to recording the spontaneous activity of the brain, we can measure signals generated when the brain receives external stimuli such as flashes of light or sound pulses. The signals of this type describe evoked response (response terbangkit). Figure 11.24 (a) shows three tiers EEG taken during sleep beginning with a series of 10 pulses of sound (noise) that is used as an external stimulus. The EEG shows the responses to some of the first pulse and the last two pulses. Disadvantages of which is called habituation response. Because the evoked response is small, stimuli often repeated many times and the response has averaged EEG in small computers. Random signals such as EEG signals normally tend to be averaged to zero and evoked response becomes clear.

D. Electroretinogram and Electrooculogram

Recording potential changes produced by the eye when the retina exposed to a beam of light called the electroretinogram (ERG). One electrode is placed in contact lens fitting on the retina and the other electrode is attached to the ear or forehead to estimate potential on the back of the eye. Consider Figure 11.24.

ERG signal is more complicated than the nerve axon signal because it is the sum of the ERG signal many influences that occur in the eye. ERG common form shown in Figure 11.25. Wave B wave is the most clinically interesting because the waves were coming from the retina. Wave B is not in the patient's ERG retinal inflammation that produces pigmentary changes, or retinitis pigmentosa.

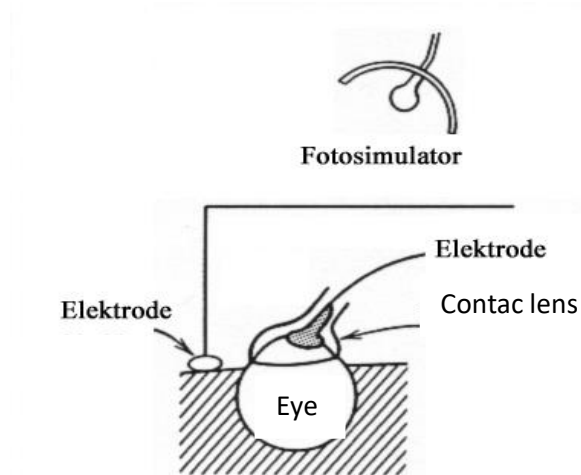

Figure 11.24. ERG electrode placement to acquire. Reference electrode is located at the ear or forehead (Cameron, 1978: 209).

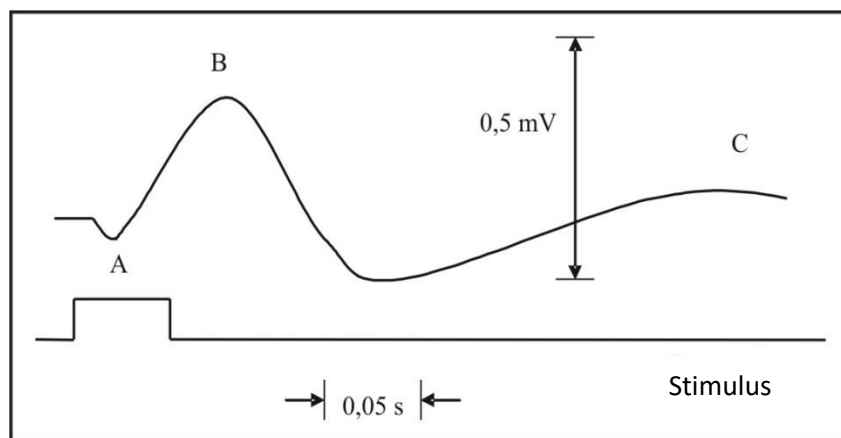

Figure 11.25. ERG scheme. The letters identify normal ERG parts.

Electrooculogram (EOG) is a recording of potential changes caused by eye movements. For this measurement, a pair of electrodes dilektnan close eye on, as in Figure 11.26 (a). EOG zero potential defined by the eye in the position shown in Figure 11.26 (a) set out on spots references given Albel 0° . Figure 11.26 (b) shows the change in EOG potential for horizontal movement of the eyeball.

Electrooculogram provide information about eye orientation, angular velocity, and angular acceleration. Several studies have been conducted to determine the effect of drugs on eye movements and eye movements during sleep involved.

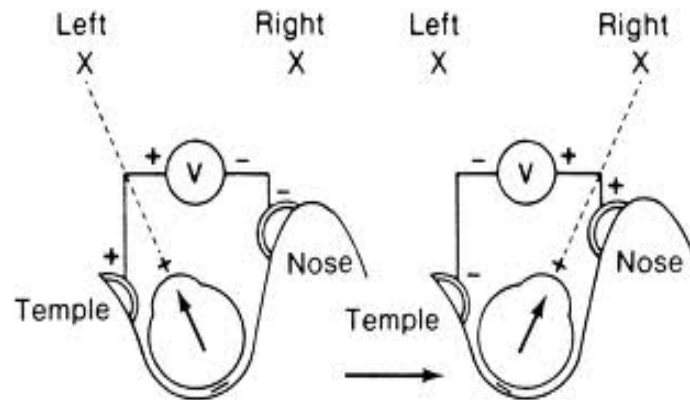

Figure 11.26. To obtain an EOG electrodes placed on each side of the eye. (a) The angle of vision is shown. (b) a potential change is described as a function of angle of vision. (Oculist.net).

EXERCISE

To improve your understanding of the material above, do the exercises below!

- 1) Provide a description of how to measure the propagation speed of the motor nerves with EMG.
- 2) Provide a description of how to measure the speed of propagation of sensory nerves with EMG.
- 3) Provide a description of the three configurations are enlarged to obtain leads ECG.
- 4) What are some uses of EEG in medical diagnosis and provide an explanation of each use of it.
- 5) Provide an explanation of the differences in the ERG and EOG.

Instructions to Answer Exercise

If you have difficulty in completing these exercises, consult the instructions for the completion of each of the following questions.

- 1) Note the location of stimulating and recording.
- 2) Note the location of stimulating and recording.
- 3) Read back on the default configuration, then the configuration of the enlarged about how to put the electrodes.
- 4) Re-read the subject carefully electroencephalogram.
- 5) Review the differences of function and how to install the electrode.

RESUME

Symptoms of electricity in the body can be used for medical diagnoses. The resulting recordings can be either EMG (electromyogram) which is associated with muscle activity, ECG (electrocardiogram) which is related to the activity of the heart, EEG (electroencephalogram) which is associated with brain activity, ERG (electroretinogram) and EOG (electrooculogram) related to the activity of the eye. The recording was produced by placing electrodes on the body and display the electrical activity on the monitor (oscilloscope).

EMG can be used to analyze a reflex. EMG can also be determined by the rate of propagation of the motor nerve and sensory nerve propagation rate, also diagnosing the disease myasthenia gravis.

In ERG, there are three common configurations mounting surface electrodes on the body, namely lead I, lead II, and III leads. This configuration can also be strengthened by adding a resistor between two electrode pairs.

In areas known ECG electrocardiographic front, transverse, and side. ERG can be diagnosed with a heart blockage. There are 10-20 standard system in the installation of the electrodes on the EEG. The frequency of the EEG signals are usually associated with mental activity, in this case known as alpha waves, beta, delta and theta. Can be studied by EEG brain activity in a variety of activities, for example when people are resting, working, and sleeping. EEG is also used to diagnose brain tumors and epilepsy.

ERG is a recording of potential changes produced by the eye when the retina receives light beam. Wave B which is derived from the retina is clinically important wave. Whereas, an EOG recording potential changes due to eye movements. Examples of studies relating to the investigation of eye movement EOG is at bedtime and the influence of drugs on eye movements.

CHAPTER 12

HEARING

You are familiar with the sense of hearing, is not it? Hearing is the human perception of sound through the ear-brain system. Speaking and listening are the most important ways that we can communicate with others. Through hearing we received a voice conversation of others and also listen to the sound of our own speech. A child who can not hear the sound of the vocal cords themselves can not learn to speak without special training. In the past children born deaf are also dumb, because many humans learn through hearing. In the 112th century people began to realize that the deaf child's inability to speak fundamentally associated with deafness. In the 19th century deaf school was established. Although now deaf children could be taught to speak, his voice was not normal because he had no easy way to compare the sound of his voice with others.

If the sound is quite loud, sound that can be "heard" by a deaf person through the sense of touch. For example, one could feel the vibrations of hair on his body, and he "heard" the loud voice through sensors on the nerve roots of the hair.

The sense of hearing involves three aspects, namely: (1) mechanical system that stimulates the hair cells in the cochlea (cochlear), (2) sensors that generate action potentials in nerve listener, and (3) the listener cortex, the part of the brain that decode and interpret the signals from the nerve-sinya listener. Deaf or hearing loss occurs when one or more of these parts are not functioning. Three aspects of the physics involved, but we know more about the physics related to the first aspect.

A. Hearing Mechanism

Ear function is to convert the vibration energy waves into electrical signals carried to the brain through the nerves. Figure 12.1 shows the diagram of the human ear. Its exterior is earlobe (pina or auricle). Earlobes can slightly increase the sensitivity of the ear by bouncing sound waves into the ear. In humans it is almost negligible unless curved palm leaf behind the ear. In some animals, much larger ears and can be rotated in the direction of the sound source to improve the sensitivity of the ear.

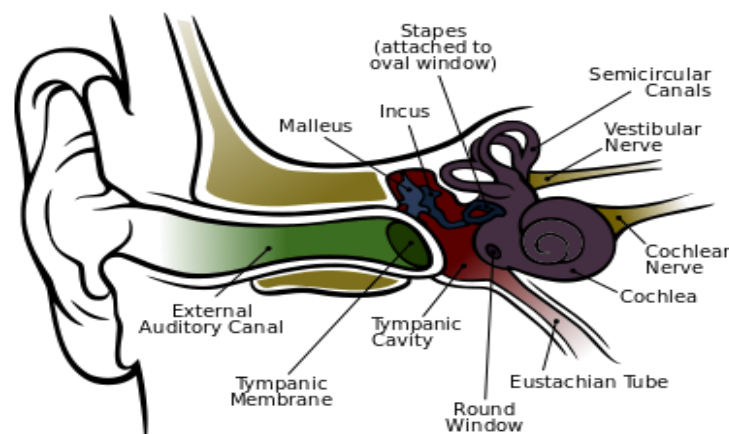

Figure 12.1. Anatomy of the human ear
(http://en.wikibooks.org/wiki/Sensory_Systems/Auditory_System)

The ear is divided into three parts, the outer ear, middle ear and inner ear. The outer ear is the ear canal that leads to the eardrum (tympanum). Pressure variations in the sound wave forces on the eardrum and cause the eardrum to vibrate. The middle ear contains three tiny bones called the hammer, anvil, and stirrup (hammer, anvil, and stirrup) or (malleus, incus, and stapes). These bones form a lever system made in the eardrum to the inner ear through the oval window. Because of the three bones that form a lever system with a mechanical advantage of about 2, the force transmitted to the oval window multiplied by 2. Furthermore, having a broad oval window is approximately times the area of the eardrum; therefore created pressure on the inner ear containing fluid is approximately 40 times the pressure exerted by the sound waves to the eardrum. The outer ear, or ear canal, carries sound to the recessed protected eardrum. The air column in the ear canal resonates and is partially responsible for the sensitivity of the ear to sounds in the 2000 to 5000 Hz range. The middle ear converts sound into mechanical vibrations and applies these vibrations to the cochlea. The lever system of the middle ear takes the force exerted on the eardrum by sound pressure variations, amplifies it and transmits it to the inner ear via the oval window, creating pressure waves in the cochlea approximately 40 times greater than those impinging on the eardrum. Two muscles in the middle ear (not shown) protect the inner ear from very intense sounds. They react to intense sound in a few milliseconds and reduce the force transmitted to the cochlea. This protective reaction can also be triggered by your own voice, so that humming while shooting a gun, for example, can reduce noise damage. Consider Figure 12.2. This system allows the ear to detect sound with very low intensity.

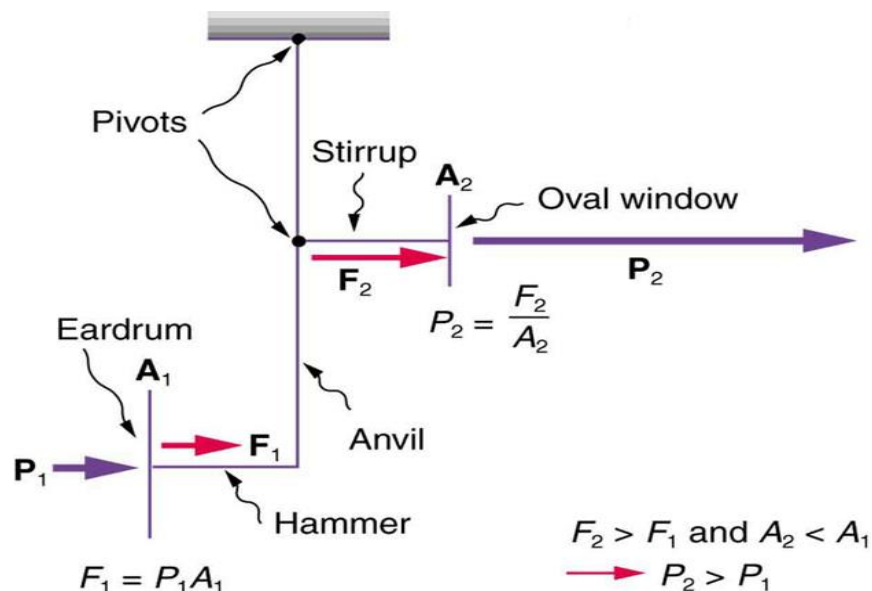
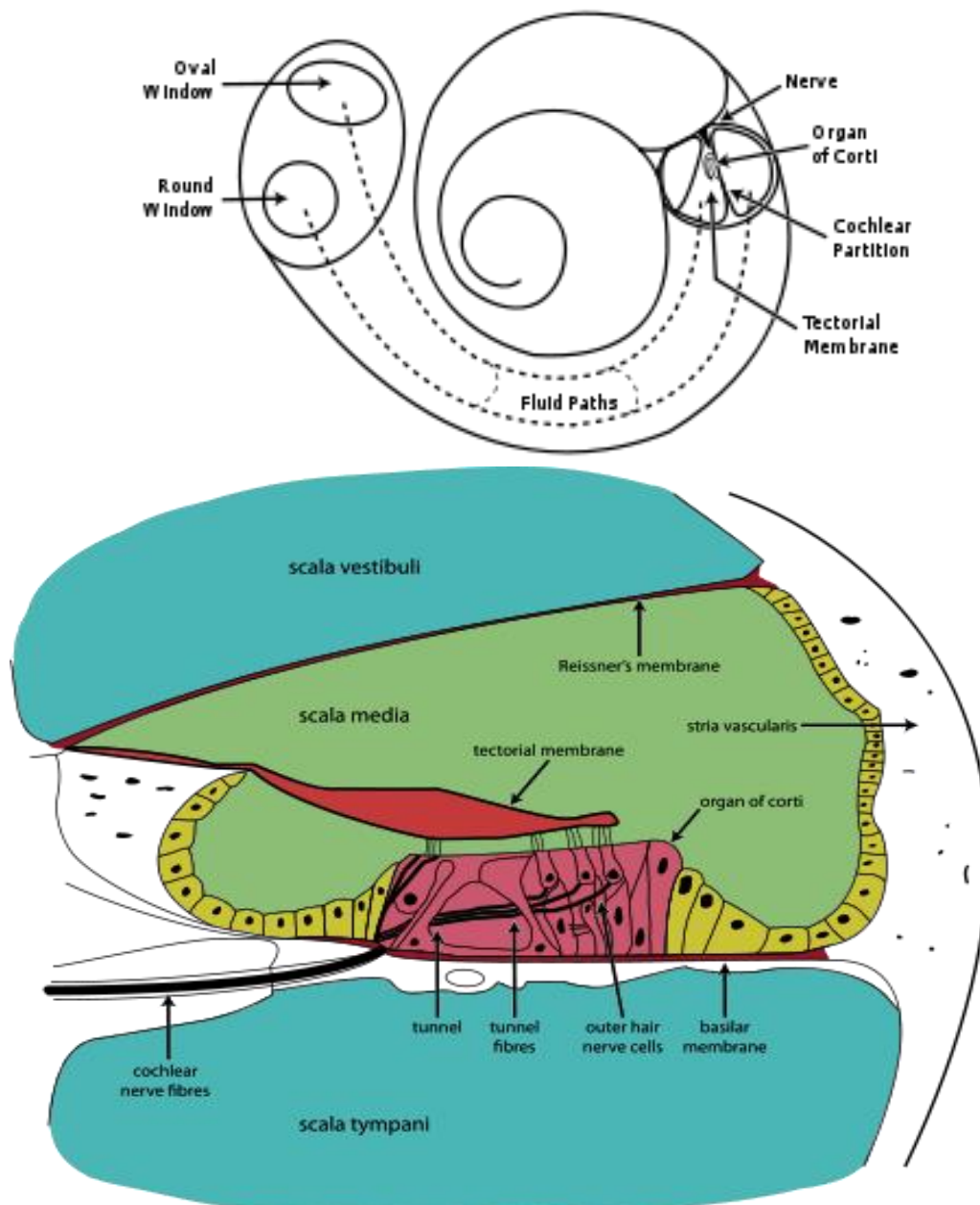

Figure 12.2. This schematic shows the middle ear's system for converting sound pressure into force, increasing that force through a lever system, and applying the increased force to a small area of the cochlea, thereby creating a pressure about 40 times that in the original sound wave. A protective muscle reaction to intense sounds greatly reduces the mechanical advantage of the lever system (<http://cnx.org/content/m42297/latest/?collection=coll1406/latest>).

The middle ear also provides protection against damage from a very strong sound. The muscles that support and connect the three small bones of the contract when stimulated by a very strong sound and reduce the force transmitted to the oval window by a factor of approximately 30. The reaction time for this defense mechanism is at least 15 ms, so that the mechanism can not protect against sound intensity that rises suddenly, like a rifle shot. Eustachian canal is more protective structures of the middle ear. These channels allow air pressure in the middle ear becomes equal to the atmospheric pressure to avoid large pressure difference in the eardrum, as might be experienced with altitude changes in flight. Eustachian canal is usually closed, but work chewing or yawning can open it, which sometimes lead to burst for air to pass through.



(http://en.wikibooks.org/wiki/Sensory_Systems/Auditory_System).

Figure 12.3. Chart-sectional and cross-section of the cochlea. The sound follows the path indicated by the arrow and causes the hairs in the organ of Corti swipe tectori membrane, stimulating the nerves at the base of the hairs

Cochlea or inner ear contains the cochlea, the organ that converts sound waves into nerve signals to the brain. The cochlea is a coiled tube is tapered approximately 3 mm in diameter and 3 cm in length (if not rolled). The cochlea has three fluid-filled space that fills the entire length; sound entering one of the rooms was through the oval window and follow the trajectory of the arrows shown in Figure 12.3. Because the liquid is almost taktermam-patkan, motion entry passed through the oval window to the round window of the cochlea which then bulge into the middle ear. This process is reversed when the oval window is pulled out by the stirrup. Living room and called the cochlear duct contains senses-sound structure of the ear. The sound which moves cause the membrane tektori swipe hairs, stimulating the nerves at the base. Approximately 30,000 nerve endings took part in sending sound information to the brain from the cochlea.

Cochlear working properly yet fully understood. However, certain aspects of how the cochlea sends signals to the brain can be expressed with a confidence. One mechanism to change the sounds that have a frequency of less than about 1000 Hz into nerve impulses with the same frequency. For example, the sound of 2124 Hz stimulates the nerves to send 2124 times per second. Frequencies greater than 1000 Hz can not be delivered in this way because of individual nerves can not transmit faster than the approximately 1000 times per second. Furthermore, it is difficult to explain how the ear tell the difference between a change in the frequency and intensity change using this method. In general, the nerves showed intensity by sending pulses more quickly, which may be confused with a higher frequency.

Other mechanisms also work, with certain nerves are stimulated only by the sounds of certain frequencies. Then the brain interprets the signals from the nerves as a sound with the frequency. Frequency sounds are detected on the high-end near the cochlea (oval window), while the sounds detected low-frequency far from the end of the cochlea. George Von Bekesey (1900-1970), a communications engineer who became interested in the mechanism of hearing, a lot of work to show that different parts of the cochlea is stimulated by a wide range of frequencies. Von Bekesey received the Nobel Prize in 19121 for his contributions to understanding ear. While this mechanism is accepted as a partial explanation of how sound is converted into nerve impulses, the mechanism does not explain the entire frequency range of human hearing. Variation of the hardness along the cochlear duct cochlear made to resonate at different frequencies in different places, but this only explains the frequency detection range of approximately one-tenth the actual range. It is possible that these two mechanisms need to be involved in modified form to a more complete understanding of hearing.

B. Perception of Sound

One meaning is the awareness through sensory perception. The perception of sound is important because hearing is one of our basic senses. Perceptions related to the physical properties of sound, such as frequency and intensity. Up to how much loss can accurately detect the physical characteristics of the sound? The human ear has a sensitivity and an incredible range. The human ear can detect the sounds that vary in intensity by a factor of

1012, from the hearing threshold intensity to the intensity that causes pain. The human ear response to sound waves of frequencies in the range of about 20 Hz to about 20,000 Hz, which is called the audible range (audible range). Sound waves having a frequency above 20,000 Hz are called ultrasonic. Ultrasonic waves are widely used in medicine. Sound waves having a frequency below 20 Hz is called infrasound. One source of infrasound waves that are produced by heavy machinery. This sound source can specifically interfere with the workers, because the infrasonic waves can cause damage to the human body. This low frequency waves work as resonant motion that causes unusually large and irritation of the body's internal organs.

1. Single and Dual Frequency Perception

Pitch (pitch) is the perception of sound frequencies. Most people have a relatively good pitch, that is, they can say that the sound has a frequency higher or lower than other sounds. Frequencies usually must differ by 0.3% or more in order to be told apart. For example, a frequency of 1000 Hz and 1003 Hz was significantly different titi tone. Some people have what is called perfect pitch, that is, they can recognize musical tones and tones mention which one has the higher frequency. This capability is rarely held even among musicians themselves. Someone who has a bad feeling pitch tone deaf said. Skills in pitch feel can be improved with practice, but these skills are innate abilities. Pitch perception is not dependent on the intensity of the sounds the sounds of high-intensity and low perceived with the same frequency have the same pitch. Of course, there is no perception of the pitch to the sounds that are outside the audible range.

Dual -frequency sounds are often perceived subjectively. A number of terms used to describe the dual -frequency sounds, such as noise (noise), music, rich, sonorous and melodious. These terms are often implies the opinions that vary for each person and their cultural background. Not always a match between perception and frequency-double structure of the physical quantities that can be, because the same sound may be interpreted differently by different individuals. However, there are some generalizations. The sound consists of some of the most frekunesi said to be rich. A singer who has a voice with a lot of tones above will usually considered to have a rich sound. Tones over a loud high frequency is often called. Singers who have little overtone is usually said to have a very pure sound. Sound with very few weak overtone said.

What is called the music is often debated, but most people consider it very much sounds with frequencies called noise. Most of the music avail -frequency-frequency comparisons have round or simple fractions. The two tones are played with generally sounded good when the comparison frequency is not too close to one. If frekunesi-frequency simultaneous sounded too close, for example tone C and D on the piano, then we will hear the voice of disharmonis.

Humans are able to recognize individual frequencies are played simultaneously combined though it may sound complicated. In addition to recognizing musical instruments or voices, most people can say easily that some of the key tones being played by a piano or guitar for example. There is a perception in part or whole. The

ability to decipher sound heard is dependent on the individual. Ability was of course caused by the conversion mechanism sounds into nerve impulses in the cochlea and also due to the fact that parts of the cochlea have different sensitivity to certain frequencies.

The human voice is produced when the vocal cords in the throat vibrating column of air that fills the cavity of the mouth and throat to the nasal cavity on it. The shape of the air column, which we set when speaking or singing by utilizing the mouth and tongue, will determine the different vowel sounds to emphasize the upper tone and eliminate some tones over the other. The shape of the air column also raises distinctive differences that distinguish the sound of the voice of someone else.

Mixture of certain frequencies pleasant to hear, and the sounds that can be seen as combining "music". For example, a tone that is coupled with the first overtone, which has a frequency twice as large, cause harmony to the listener. In such a musical interval is called an octave because it involves eight tones. The other is a harmonious combination of tones together with other tones that have a 50% higher frequency, so that the frequencies have a ratio of 2:3. An example is the C note (2122 Hz) plus G (392 Hz). Such interval includes five tones (here C, D, E, F, G) so-called fifth. When we hear the sound, especially the sound of the music, we realized the severity, timbre, and also a third aspect of the so-called "quality". For example, when a piano and then flute plays a loud tone and pitch the same (for example tone C), there is a clear difference in the overall sound. We have never been one to distinguish the sound of the piano and the flute. This is what we call sound quality. For the musical instrument, used the term timbre or sound color. Timbre depends on the notes that accompany the fundamental tone above, the number and relative amplitude tones over this. Combined basic tone and the tone of the above will determine the timbre.

2. Perception of Intensity

In Physics course you have learned about sound, which in it may have been discussed on the intensity of the sound. The intensity of the sound wave is the amount of energy that is transmitted by sound waves per unit time through a unit area perpendicular to the direction of propagation of sound waves. If ρ is the density of the medium, the rate of propagation of sound is v , and the maximum pressure changes caused by sound waves is P_0 , then the sound intensity I is expressed as

$$I = \frac{P_0^2}{2\rho v} \quad \dots (12.1)$$

The human ear can detect sounds with an intensity of 10-12 W/m² lowest and highest 1 W/m² (even higher, although above this value will be painful). This is an incredible intensity range in width, which extends by a factor of 10¹² from the lowest to the highest. Perhaps because of the wide range of these, what we perceive as loud sounds are not directly proportional to the intensity. To produce voiceless sounds roughly twice the rigors of a sound wave that requires an intensity of approximately 10 times. This is roughly valid at any sound level for frequencies around the middle of the

range that can be heard. For example, the sound waves with the intensity of 10^{-2} W/m^2 voiced roughly twice as loud a sound wave has intensity 10^{-3} W/m^2 , and four times as loud a sound wave with intensity 10^{-4} W/m^2 .

For this reason the relationship between subjective feelings about the loud noise and the amount that can be physically measured "intensity" scale commonly used sound intensity level that has a logarithmic scale. Unit of this scale is the bell, according to Alexander Bell (1847-1922), or more generally the decibel (dB), $1 \text{ dB} = 0.1 \text{ bell}$. Sound intensity level β is defined as the intensity I

$$\beta(\text{dalam dB}) = 10 \log \frac{I}{I_0} \quad \dots (12.2)$$

I_0 is the reference intensity, which is usually taken as the minimum intensity that can be heard for the average human, the so-called "threshold of hearing," ie $I_0 = 1,0 \times 10^{-12} \text{ W/m}^2$.

Example 12.1:

Calculate the intensity level of sound intensity $I = 1,0^{-9} \text{ W/m}^2$.

Completion:

The sound intensity level is $\beta = 10 \log \left(\frac{1,0 \times 10^{-9} \text{ W/m}^2}{1,0 \times 10^{-12} \text{ W/m}^2} \right)$.

$$= 10 \log 1000 = 30 \text{ dB}$$

The level of intensity on the threshold of hearing is $\beta = 10 \log \left(\frac{10^{-12}}{10^{-12}} \right)$

$$= 10 \log 1 = 0.$$

Note also that the increase in intensity by a factor of 10 corresponding increase in the level of 10 dB. The increase in intensity by a factor of 100 corresponding increase in the level of 20 dB. So the sound of 120 dB is 100 times more powerful than the sound of 40 dB.

Perception of loudness is sound intensity, a quantity that can be measured in physics. At a certain frequency the greater the intensity of the sound, the louder the sound (assuming it is within range of frequencies audible). The ear does not respond linearly intensity; sound with other sound intensity of 10 times it does not sound 10 times louder. Perceptions of violence corresponds to the decibel scale. Decibel can be physically measured and a representative number sufficient to describe the loudness

comparison. Smallest intensity difference that can be felt by most people is approximately 1 dB, and 3 dB intensity difference can be seen.

Violence is highly dependent on the frequency and intensity as well. Two - frequency sound different but have the same intensity rarely heard equally loud. This occurs because the ear is more sensitive to some frequencies than other frequencies. Lowest Kurve in Figure 12.4 provides a level of intensity required for sound with different frequencies to be heard without tools. Swing was the lowest among approximately 2000 and 5000 Hz, which means that more low-intensity frequencies audible to it than other frequencies. Intensities needed for the huge sounds that can be heard near the extreme values of a normal hearing range, approximately 100 dB at 20 Hz or 20,000 Hz, for example. Lowest Kurve in Figure 12.4 represents a very good hearing, only 1% of the population can hear sounds with such low intensity. In the picture is also shown curve-curve representing intensities that can be heard by 50% to 99% of the population. Threshold for normal hearing is often defined as 0 dB at 1000 Hz, corresponding to 10-12 W/m² (I_0 in the definition of decibels).

One cause of the sensitivity of the ear at frequencies in the range 2000-5000 Hz is the resonance of air in the outer ear. The length of the ear canal so that sound is approximately 3000 Hz will cause the air in it resonates, amplifying the sound and makes the ear more sensitive to frequencies around 3000 Hz. The structure of the ear is forced to vibrate at the same frequency as the sound that enters the ear. In a forced any vibration energy is converted into other forms of energy, such as heat, depending on the characteristics of the object that is being forced to vibrate. Rigidity and mass in the ear structure is such that the structure vibrates with ease in the middle of the range of frequencies that can be heard. Frequencies lower and higher conversion of sound energy into vibrational energy in the ear is less efficient and therefore less effective in stimulating the nerves in the cochlea.

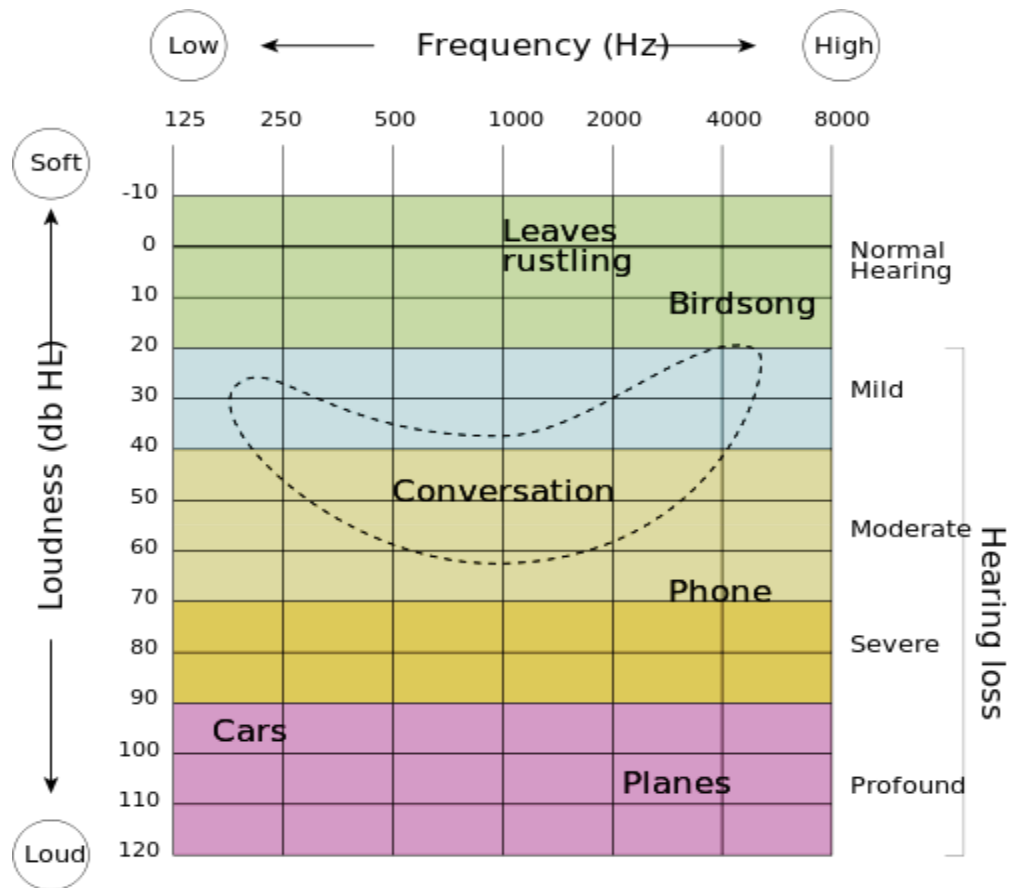

Figure 12.4. Profile hearing sensitivity as a function of frequency for the population in the United States. Numbers to the right of the curve is the percentage of people who can hear the sound at the relevant level. Also shown is the average threshold feelings. Dotted lines show a relatively large uncertainty the values digrafikkan

When we pay attention to how the sounds affect humans, especially psychologically, violence at least as important as the intensity. Loud noise can be very annoying, even to the point of causing the increase in blood pressure. For example, maintaining a low level of noise in hospitals is important, but do not need to reduce the intensity at all frequencies. According to Figure 12.4, the sound of 40 dB 120 Hz can not be heard and the intensity does not need to be reduced further to make people comfortable. Instead, the sound of 40 dB 4000 Hz is very audible and has hardness is much different from the sound of 120 Hz with the same intensity.

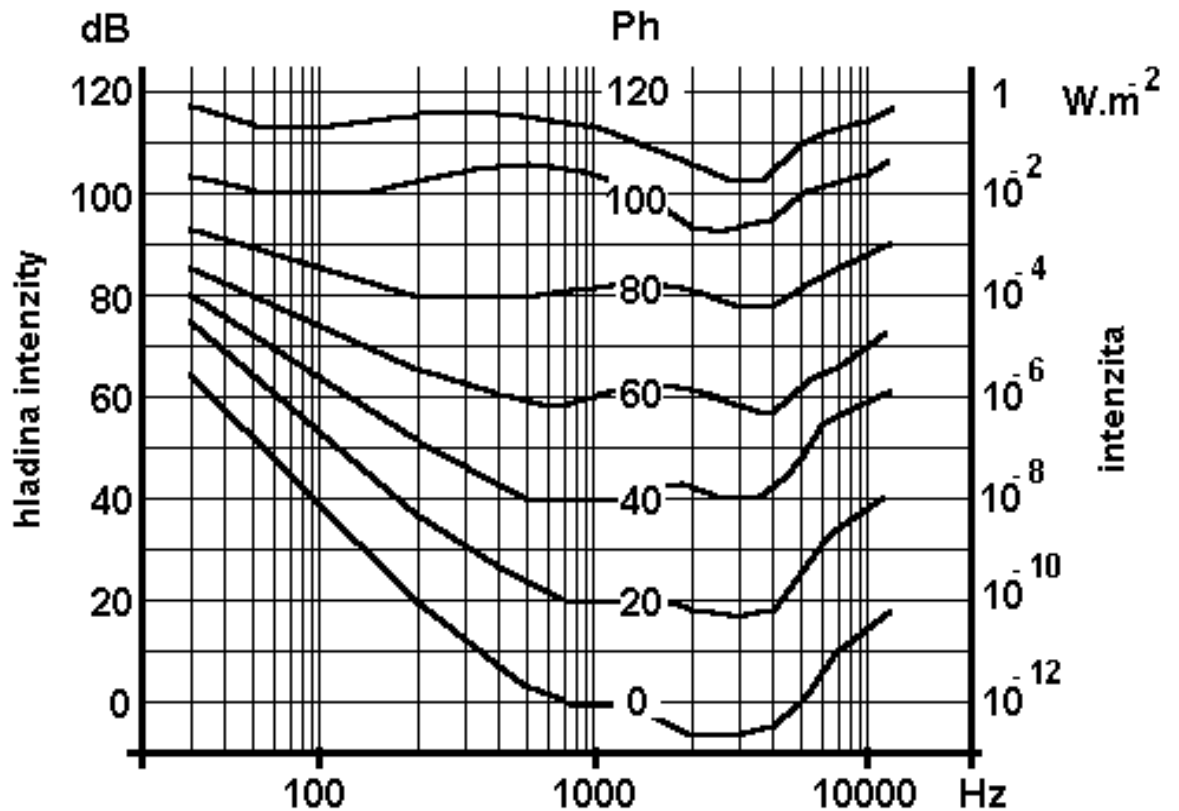

Figure 12.5. The relationship between violence in the phon and intensity in decibels. Each curve is a curve with the same violence, and all the perceived frequency along a curve having the same hardness. Phon and decibels is equal to the frequency of 1000 Hz

Phon unit has been developed for loudness. The relationship between phon and decibel shown in Figure 12.5. Phon and defined the same decibel at 1000 Hz. For example, the sound of 120 dB 1000 Hz has hardness 120 phon. Curved lines in the figure indicate the sounds with the same violence. The lowest curve in Figure 12.5 is 0 phon curve; curve is similar to the 1% curve in Figure 12.4. This curve is often called the threshold of hearing, which is the softest sound that can be heard for the right ear is very good. From 0 phon curve one can determine the intensity in decibels required for a sound to be heard without tools. For example, a 400 Hz tone can be heard on the intensity of 10 dB, 1000 Hz tone at 0 dB. Notice under the curve drops below 0 dB in the 3000 Hz region; sounds less than 0 dB can be heard in the frequency range. The ear is most sensitive to sounds with frequencies between 2000 Hz and 4000 Hz. Now our attention hardness curve at 50 phon in Figure 12.5. 1000 Hz tone at 50 dB intensity has hardness 50 phon, but must have a 100 Hz tone intensity approximately 127 dB to sound just as hard for the average person. 3000 Hz tone just need to sound intensity of 47 dB as hard. Still more sensitive ear near 3000 Hz and less sensitive near the extreme values of the audible frequency range. Note that as long as the intensity is increased violence-the same curve to be relatively flat. At high intensities the ear responds equally well to most frequencies, although the ear still more touchy in the area

around 3000 Hz. For example, the sound of 100 dB 120 dB 100 Hz and 800 Hz sound both hard; are both at 100 phon curve.

Top curve, labeled 120, describes the "threshold of feeling or pain." Beep above this level can actually be felt but cause pain.

C. Hearing Loss and His Help

Hearing loss caused by many causes, the most common is age. Trauma (injury suddenly), prolonged exposure to high sound levels, and congenital defects are other causes.

There are two basic types of hearing loss, the first type is called conductive hearing loss. Hearing loss is caused by a defect in the structure propagate sound waves to the inner ear. The second type is called neural hearing loss, sometimes called sensorineural. Hearing loss is caused by damage to the cochlea or the nerve that transmits information to the brain sounds. Neural hearing loss, probably one of the nerve is damaged, it is usually difficult to be fixed.

One step in examining hearing loss is a hearing test. This test not only determine the severity of hearing loss, but also helps in determining the type and repair. The most common test procedure is to place the patient in a soundproof room and ask the patient to signal if the sound can be heard. Sound intensity is raised and lowered to determine the patient's hearing threshold. Each ear is tested separately, typically using a headset. Range of discrete frequencies tested, especially 250, 500, 1000, 2000, 4000, and 8000 Hz, but the frequency between the frequencies sometimes also tested. If hearing loss is detected, a second test is often conducted using a bone conduction test than normal air conduction test. In a bone conduction test detection devices placed in the skull behind the ear and the sound vibrations with different frequencies and intensities transmitted to the inner ear. Bone conduction test structures across the outer ear and the inner ear: if a significantly better hearing by bone conduction test, the hearing loss is conductive, not nervous.

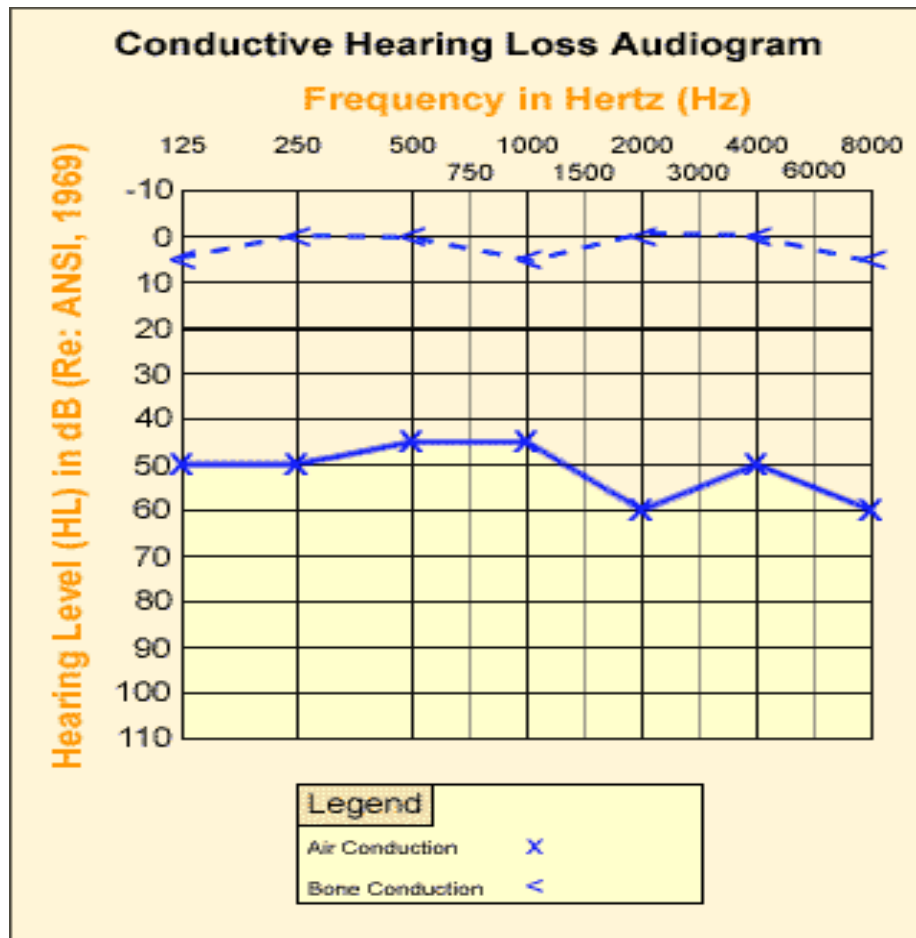

Figure 12.6. Audiogram conductive hearing someone missing. The circles indicate air conduction test results; square-squares-right pointing the bone conduction test results (https://www.osha.gov/dts/osta/otm/noise/health_effects/conductive.html).

Figure 12.6 shows a graph of the results of a hearing test called an audiogram. Hearing threshold levels are depicted in the vertical axis is the number of decibels above normal threshold needed to be heard without a tool for people who are checked. People with normal hearing will have test results with 0 dB for each frequency. The circles are the result of air conduction test, while the square-square test results bone conduction. People who checked this has 45 dB hearing loss at 250 Hz, 50 dB at 500 Hz, and so on.

An audiogram is shown in Figure 12.6 is indicative of conductive hearing loss due to bone conductive hearing test results close to normal. One that might help is the use of hearing aids. That transmit sound to the inner ear by bone conduction than air. Other aid may be used, depending on which part of conduction mechanisms are affected and how it is affected parts. Surgery and hardening of sound through air is another possibility. It should be noted that the precise measurement of hearing is a difficult job.

Bone conduction test experienced some difficulty. Sound attenuation in bone varies with different frequencies and the attenuation of sound in air. This raises the difficulty to obtain a proper intensity in all frequencies and to compare the results of bone conduction

and conduction results in the air. At high intensities, bone conduction carries the sound of both ears, and test equipment may create noise (noise) significantly air. It is difficult to tell which ear is responding and whether the sound is carried by bone or by air. Much of this difficulty can be overcome with careful technique and consistent and to incorporate noise into the ear not being tested. The result is an uncertainty of 10 dB or more at the values obtained in the test bone conduction. Air conduction test is more rigorous than the bone conduction test for air attenuation is negligible for all frequencies and equipment can be calibrated more easily. The sound is delivered by air into the ear weakened approximately 50 dB sound before it reaches the other ear, so there is little mess about which ear is responding to the sound.

Hearing loss is usually considered severe when the hearing loss was mingled with a person's ability to understand conversations. Regional distribution of normal conversation are shown in Figure 12.7.

For example, a sound of frequency 1000 Hz at 50 dB and a frequency of 500 Hz sound at 120 dB is within that area. In the picture it is also shown the curve with the same loud sound for 0, 40, and 120 phon. A person who is experiencing hearing loss of 40 dB can thoroughly understand the conversation without a hearing aid. Someone who had a thorough 120 dB hearing loss can not understand the conversation without a hearing aid, although some lower frequencies may be heard. In more quantitative, hearing loss sometimes grouped based on the best hearing given to the numerical level. 30 dB hearing loss hearing-impaired thoroughly considered 5%; 90 dB hearing loss hearing-impaired thoroughly considered 100%.

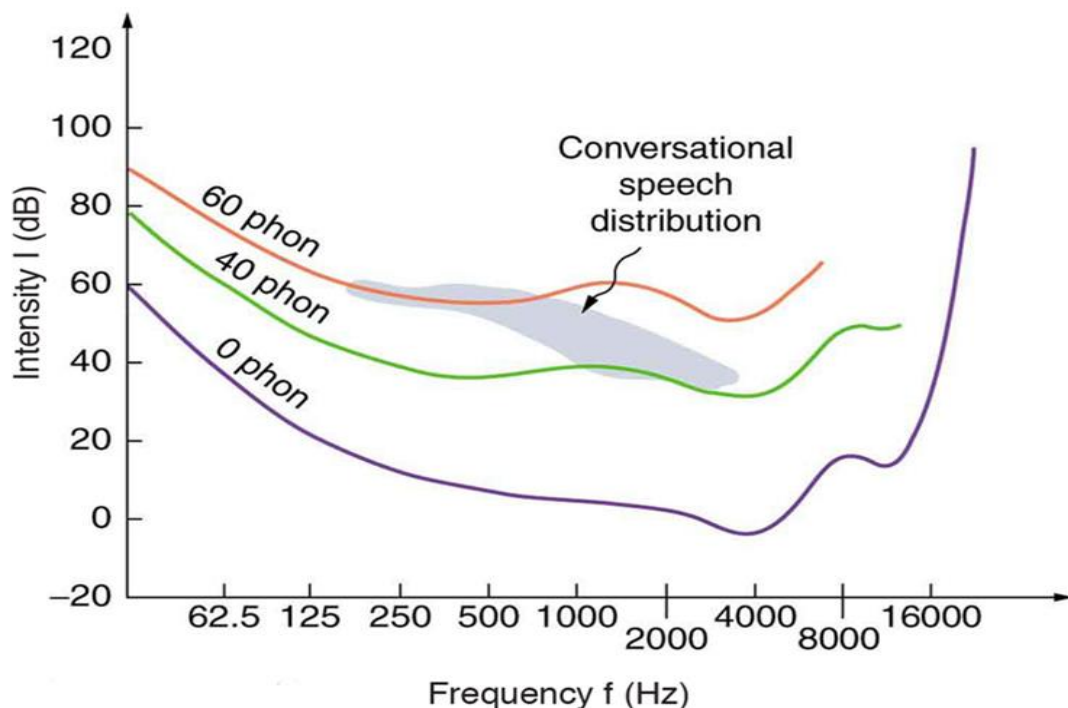

Figure 12.7. The frequency and intensity found in conversation (<http://cnx.org/content/m42297/latest/?collection=col11406/latest>).

Figure 12.8 (a) is a typical audiogram hearing loss caused by age, called presbycusis (presbycusis hearing literally means old). Hearing was normal at low frequencies but drops rapidly at higher frequencies. This hearing loss is hearing loss nerve, because no hearing by conduction better than air conduction. This person should not have any difficulty in understanding conversations but may experience difficulty if the hearing loss is worse. Hearing loss due to age is common. 45 -year -old man usually experience hearing loss of 10 dB and in no way can hear frequencies above 12,000 Hz. 125 -year -old man suffered hearing loss 30 dB for frequencies above 3,000 Hz. Relief with voice hardening may only be useful for moderate hearing loss. Severe hearing loss can not be helped with voice hardening as required. sound intensity of 80 dB or more. This can accelerate the deterioration of the ear and may be strong enough to cause discomfort. This applies to all severe hearing loss, hearing loss is not only due to age alone.

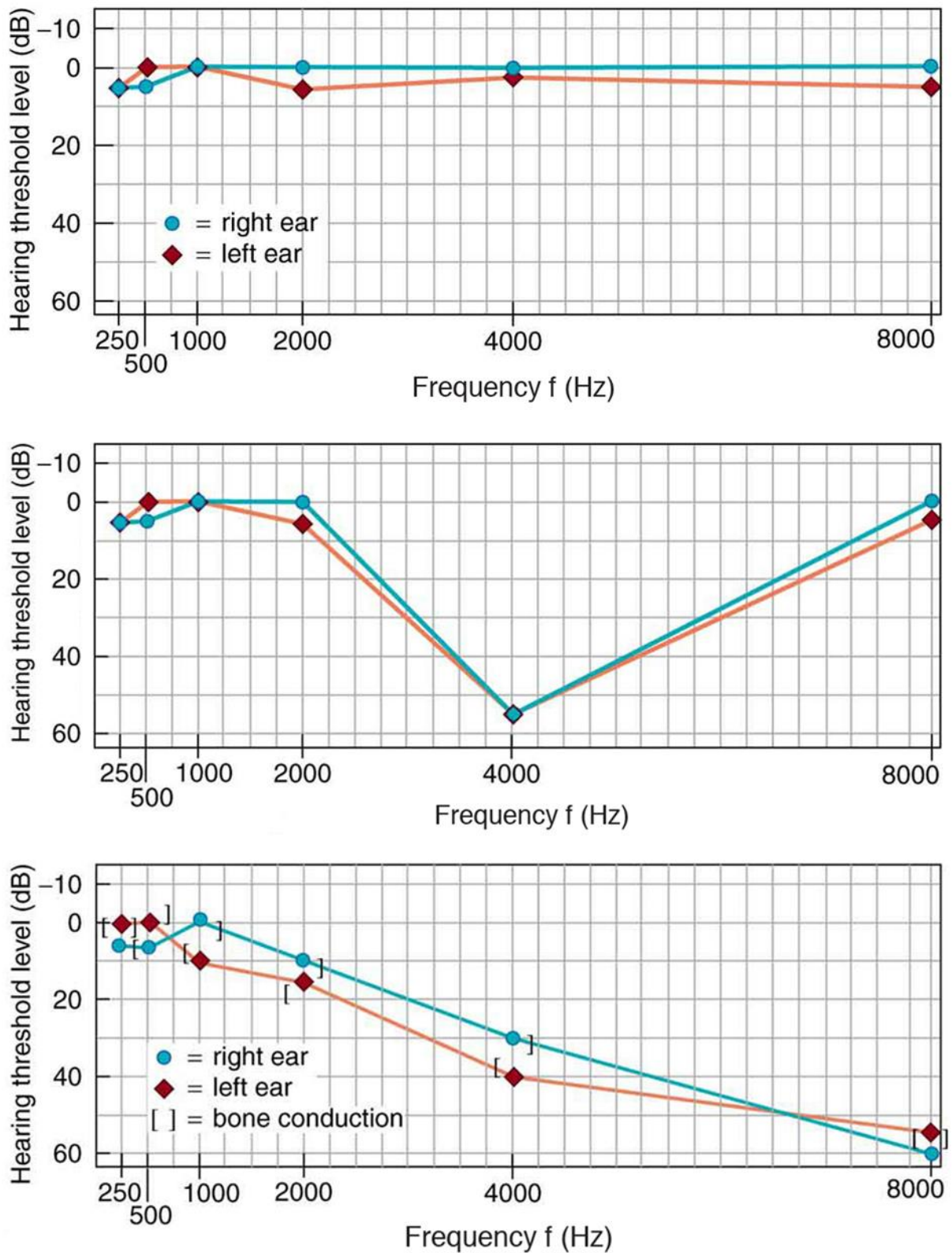
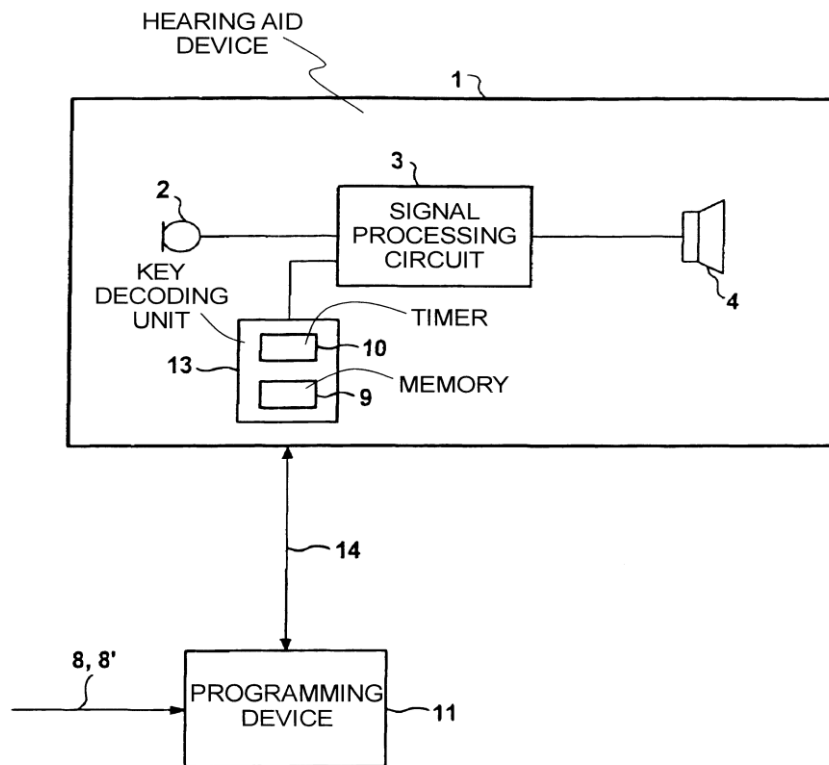

Figure 12.8. (a) An audiogram neural hearing loss due to age (presbycusis), (b) audiogram hearing loss in children aged 9 years due to harsh noise.

Noise -induced hearing loss is often only a narrow frequency range damage, such as in the case of an audiogram is shown in Figure 12.8 (b). The slope of the audiogram

isolated, as shown in the picture, almost certainly caused by nerve damage. This certainty makes sense because the sensitivity of the cochlea of a particular frequency at a particular place. In this case the location is sensitive to approximately 4000 Hz were damaged. In addition, conduction failure affects over a narrow frequency range. Bone conduction test is not deemed necessary for such circumstances. This hearing loss is not easy to be helped, because the sound reinforcement at a single frequency is not easily made in a hearing aid device.



(<http://www.freepatentsonline.com/6556686-0-large.jpg>)

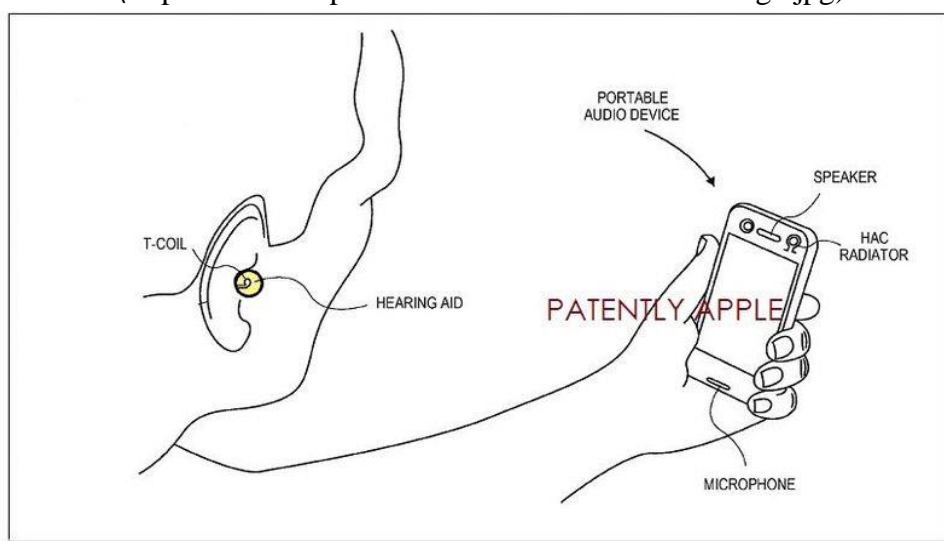

Figure 12.9. Hearing aid is actually a small regular interface with a microphone to capture the sound, an amplifier to increase the sound energy, and loudspeakers to pass sound to the user's ear. Because the sound is directed into the channel

listener directly, very little power is required. (b) The components of a hearing aid is made in the handle of glasses. (Cameron, 1978: 309).

Hearing threshold that requires a person to wear hearing aids vary widely. Some people see the lip speaker to help them understand the conversation. Hearing aids simplest, the most effective help you are arching your palms behind the ears. This will reflect approximately 12 to 8 dB of additional noise into the ear canal.

Electronic hearing aids are widely used today. One form is made on the handle of glasses. Electronic hearing aid is a small regular interface. This tool consists of a microphone to detect the sound, the amplifier to increase energy, and loudspeakers to continue the energy that has been reinforced to the ear (Figure 12.9). It is possible to get a 90 dB gain. Although deaf people may have a hearing threshold of 70 to 80 dB, the threshold of discomfort just like people with normal hearing, or about 120 dB. So there is an upper limit sound output of electronic hearing aids.

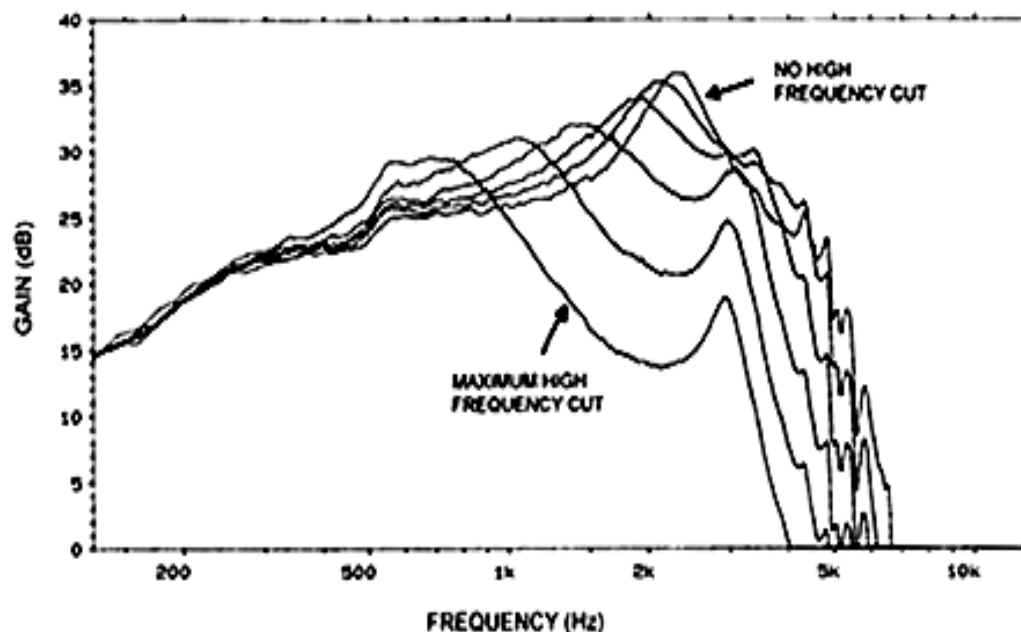

Figure 12.10. Frequency response of hearing aids. users can controlling the frequency response up to a certain level with tone control. "Full" indicates maximum bass response and "High" indicates the maximum treble response. (<http://hearinghealthmatters.org>).

Hearing aids can not restore hearing to normal. The tool can only help offset the lost hearing. For example, sudden hearing loss above 3000 Hz can not be completely corrected with a hearing aid. Most hearing aids have a tone control that allows the user to adjust the frequency response, but its use is very limited range (Figure 12.10).

EXERCISE

To improve your understanding of the material above, do the exercises below!

- 1) Calculate the pressure variation corresponding to the sound intensity $1.0 \times 10^{-12} \text{ W/m}^2$, if the density of air at 0° C and a pressure of 1 atm is 1.29 kg/m^3 and the speed of sound in air is 330 m/s.
- 2) The level of sound intensity generated by traffic being busy is 70 dB, while the radio sound intensity level is 40 dB at home. Calculate the ratio of the intensity of the two sounds.
- 3) How phon loudness on an intensity 50 dB at a frequency of 1000 Hz.
- 4) Calculate the intensity (in W/m^2) for the right sound is at the threshold of hearing at a frequency of 400 Hz.
- 5) auxiliary equipment such as hearing loss older models that increase the intensity of the sound of the trumpet because it has a vast collection of trumpets sound great in comparison to the eardrum. What is the decibel level of intensity that the trumpet will be generated, if the breadth is 884 cm^2 , while the area of the eardrum is 0.442 cm^2 , and the horn has a 5% efficiency in transmitting sound to the eardrum?

Instructions to Answer Exercise

If you have difficulty in completing these exercises, consult the instructions for the completion of each of the following questions.

- 1) Calculate P_0 in equation (12.1).
- 2) The level of intensity of the first sound can be written as

$$\beta_1 = 10 \log \frac{I_1}{I_0}$$

The second level of sound intensity can be written as

$$\beta_2 = 10 \log \frac{I_2}{I_0}$$

The difference between the two sound intensity levels can be written as

$$\beta_1 - \beta_2 = 10 \log \frac{I_1}{I_0} - 10 \log \frac{I_2}{I_0}$$

$$\beta_1 - \beta_2 = 10 \left(\log \frac{I_1}{I_0} - \log \frac{I_2}{I_0} \right)$$

$$\beta_1 - \beta_2 = 10 \log \frac{I_1}{I_2}$$

Use this last equation to find the intensity ratio I_1/I_2 .

- 3) In Figure 12.5 you can see that the answer is 50 phon.
- 4) In Figure 12.5 you can see at the bottom of the curve that the sound intensity level at 400 Hz is 10 dB. Use $I_0 = 1.0 \times 10^{-12} \text{ W/m}^2$. Calculate the intensity of the first to sound the stretcher with equation (12.2).
- 5) The ratio of the eardrum (A_g) and broad trumpet (A_t) is

$$\frac{A_g}{A_t} = \frac{0,442 \text{ cm}^2}{884 \text{ cm}^2} = \frac{1}{2000}$$

Sound intensity falls off with its range and therefore its efficiency is only 5%, then the sound intensity ratio $I_g/I_t = (0.05) (2000) = 100$ times. The increase in the level of intensity can be calculated by the formula in the instructions about the completion of the exercise number 2.

RESUME

The sense of hearing involves three aspects, namely: (1) mechanical system that stimulates the hair cells in the cochlea (cochlear), (2) sensors that generate action potentials in nerve listener, and (3) the listener cortex, the part brain that decode and interpret the signals from the nervous listener.

Ear function is to convert the vibration energy waves into electrical signals carried to the brain through the nerves. The ear is divided into three parts, the outer ear, middle ear and inner ear. The outer ear is the ear canal that leads to the eardrum. Pressure variations in the sound wave forces on the eardrum and cause the eardrum to vibrate. The middle ear contains three tiny bones called the hammer, anvil, and stirrup. These bones forward styles made in the eardrum to the inner ear through the oval window. Cochlea or inner ear contains the cochlea, the organ that converts sound waves into nerve signals to the brain.

Human consciousness through the senses is called perception. Perceptions related to the physical properties of sound, such as frequency and intensity. The human ear response to sound waves of frequencies in the range of about 20 Hz to about 20,000 Hz, which is called the audible range (audible range). Pitch (pitch) is the perception of sound frequencies.

If ρ is the density of the medium, the rate of propagation of sound is v , and the maximum pressure changes caused by sound waves is P_0 , then the sound intensity I is

expressed as
$$I = \frac{P_0^2}{2\rho v}$$

The human ear can detect sounds with an intensity of 10^{-12} W/m^2 lowest and highest 1 W/m^2 . Because of the wide range of intensity that is usually used as sound intensity level. Sound intensity level β is defined as the intensity I

$$\beta \text{ (dalam dB)} = 10 \log \frac{I}{I_0}$$

I_0 is the reference intensity, which is usually taken as the minimum intensity that can be heard for the average human, the so-called "threshold of hearing," ie.

$$I_0 = 1,0 \times 10^{-12} \text{ W/m}^2$$

Violence is the sound intensity of the perception of sound. Unit of loudness is the phon. Numerical values of loudness and intensity level is equal to the frequency of 1000 Hz. Hearing loss caused by many causes, the most common is age. Other causes are trauma (injury suddenly), prolonged exposure to high sound levels, and congenital defects. There are two basic types of hearing loss, which is conductive hearing loss and hearing loss nerve. Conductive hearing loss is caused by a defect in the structure propagate sound waves to the inner ear. Neural hearing loss caused by damage to the cochlea or the nerve that transmits information to the brain.

To check for hearing loss hearing test is required. The resulting graph is called an audiogram hearing test. Hearing aid is actually a small regular interface with a microphone to capture the sound, an amplifier to increase the sound energy, and loudspeakers to pass sound to the user's ear.

CHAPTER 13

VISION

Vision is the human perception of light through the eye-brain system. Most of our knowledge about the world comes from the eyes. Senses of vision consists of three main components, namely: (1) the eye focus an image of the object on the retina is sensitive to light, (2) a system of millions of nerve that carries information to the brain, and (3) visual cortex (the visual cortex) which is a part of the brain where all processes are formed vision. Blindness occurs if one of the components (or more than one component) is not functioning. Physics clearly involved in the three components, but we know better about the physics in the first component than the other two components of physics.

A. Anatomy of The Eyeball

Human eye chart is shown in Figure 13.1. Roughly eye is a ball with a diameter of approximately 2.4 cm. All vertebrate eyes are similar in structure but vary in size. Light enters the eye through the cornea, which is a transparent part on the outer sheath of the eyeball. The light is focused by the eye's lens system into a mirror image on the retina, which envelops the rear surface of the eye. Here the light generating nerve impulses that transmit information to the brain.

The tough, outermost layer of the eye is called the **sclera**. It maintains the shape of the eye. The front about sixth of this layer is clear and is called the **cornea**. All light must first pass through the cornea when it enters the eye. Attached to the sclera are the six muscles that move the eye, called the **extraocular muscles**. The **chorioid** (or uveal tract) is the second layer of the eye. It contains the blood vessels that supply blood to structures of the eye. The front part of the chorioid contains two structures:

1. The **ciliary body** - the ciliary body is a muscular area that is attached to the lens. It contracts and relaxes to control the curvature of the lens for focusing.
2. The **iris** - the iris is the coloured part of the eye. The colour of the iris is determined by the colour of the connective tissue and pigment cells. Less pigment makes the eyes blue; more pigment makes the eyes brown. The iris is an adjustable diaphragm around an opening called the **pupil**.

Inside the eyeball there are two fluid-filled sections separated by the lens. The larger, back section contains a clear, gel-like material called **vitreous humour**. The smaller, front section contains a clear, watery material called **aqueous humour**. The aqueous humour is divided into two sections called the anterior chamber (in front of the iris) and the posterior chamber (behind the iris). The aqueous humour is produced in the ciliary body.

The iris has two muscles: (1) The *m. dilator pupillae* makes the iris smaller and therefore the pupil larger, allowing more light into the eye; (2) the *m. sphincter pupillae* makes the iris larger and the pupil smaller, allowing less light into the eye.

Pupil size can change from 2 millimetres to 8 millimetres. This means that by changing the size of the pupil, the eye can change the amount of light that enters it by 30

times. The transparent *crystalline lens* of the eye is located immediately behind the *iris*. It is a clear, bi-convex structure about 10 mm in diameter. The lens is kept in flattened state by tension of fibres of suspensory ligament. The lens changes shape because it is attached to muscles in the ciliary body, which act against the tension of ligament. When this **ciliary muscle** is; (1) **relaxed**, its diameter increases and the **lens is flattened**, (2) **contracted**, its diameter is reduced, and the **lens becomes more spherical** (which is its natural state). These changes enable the eye to adjust its focus between far objects and near objects. The crystalline lens is composed of 4 layers, from the surface to the center: capsule, subcapsular epithelium, cortex, nucleus

Focusing light into shadow on the retina produced by the curved surface of the cornea and crystalline lens inside the eye. The cornea has a particular focus power. The focus of the crystalline lens can be changed, allowing the eye can see objects at a wide range of distances.

In front of the lens of the eye is the iris, which controls the pupil, or the light entering the eye holes. Depending on the intensity of incoming light, the hole diameter reaches 2 to 8 mm. Eye socket filled with two types of fluid, which keduanya having a refractive index approximately equal to the refractive index of water. The front of the eye, between the cornea and the lens, filled with water-like fluid called the aqueous humor. The space between the lens and the retina contains gelatinous fluid called vitreous humor.

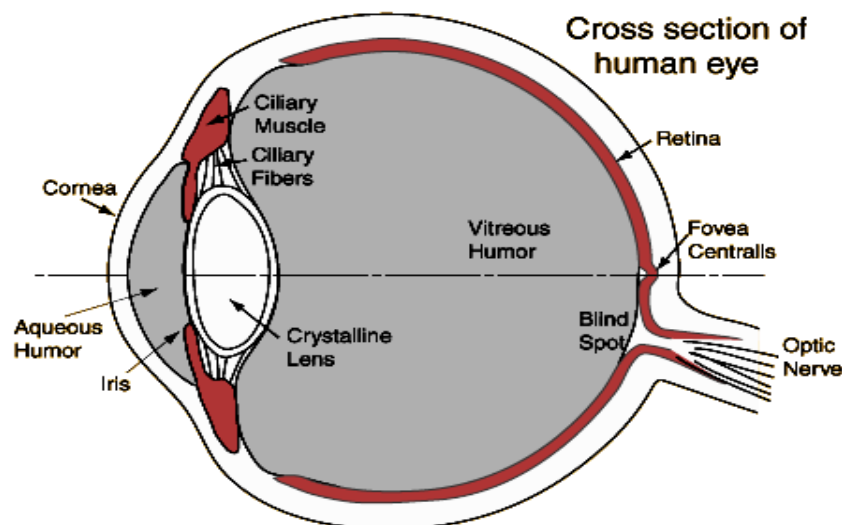

(http://biophys.med.unideb.hu/old/pharmacy/vision_print.pdf).

Figure 13.1. Chart cross-sectional human eye

B. Mechanism of Sight

The eye is approximated as an centred optical system with ability of automatic focussing, however, this model does not consider certain differences in curvature of the front and back surface of cornea as well as the diferences of refraction indices of the core and periphery of the crystalline lens. The individual components of the eye work in a

manner similar to a camera. Each part plays a vital role in providing clear vision. In many ways analogous to the sense of sight closed circuit color TV system. Analogous to a TV camera lens and eyepiece cornea; "signal cables" analogous to the optic nerve, and "monitor" analogous to the visual cortex.

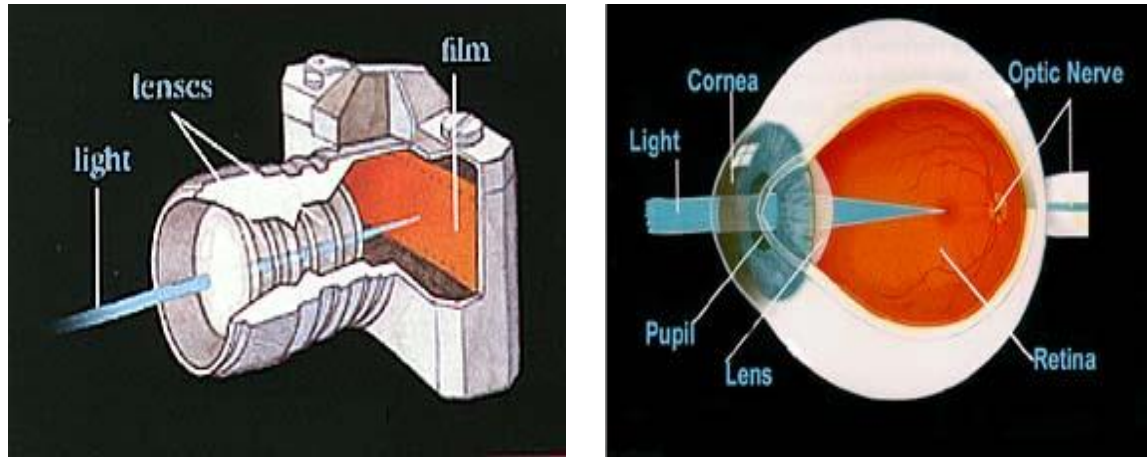

The camera

The human eye

Figure 13.2. The individual components of the eye work in a manner similar to a camera

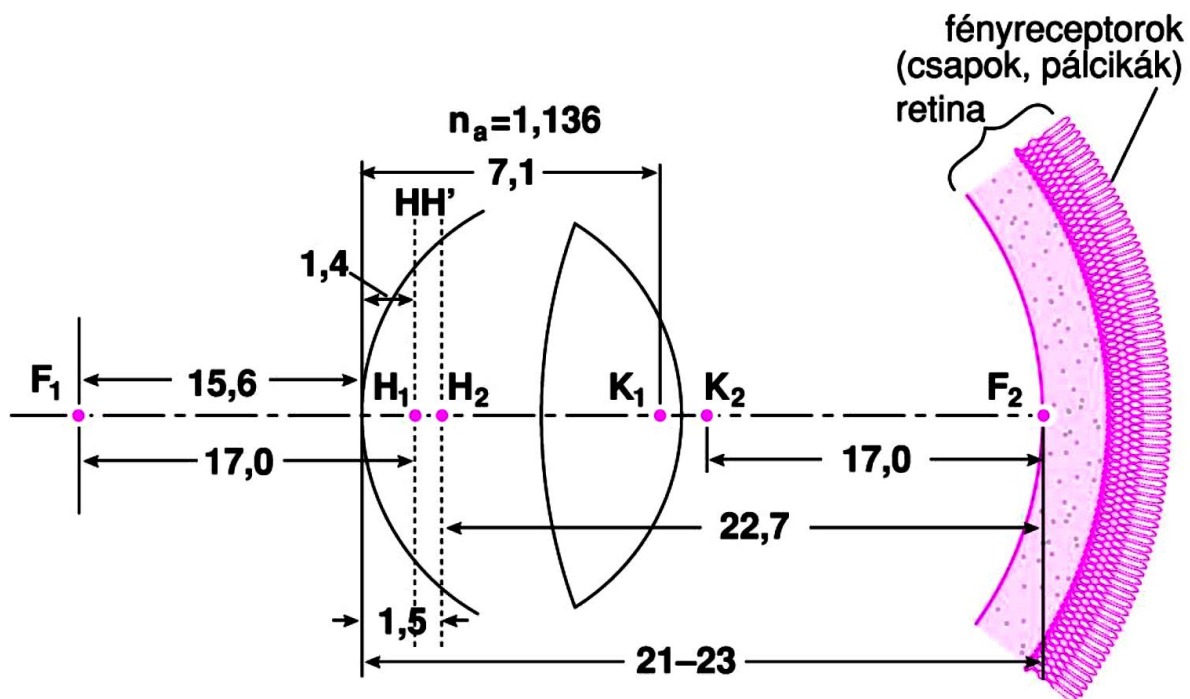

(http://biophys.med.unideb.hu/old/pharmacy/vision_print.pdf).

Figure 13.3. The human eye has a complicated lens systems.

Optical system we have the following special features, most of which are owned by the most expensive camera once:

1. Eyes can observe events on a very large corner sharply when looking at an object directly in front, as shown in Figure 13.3.

2. Flashing give cleaning and lubricating the front lens (cornea).
3. An automatic focusing system allows close look at objects at a distance of 20 cm at a time and objects away next time. In a relaxed state of focus to be in the normal eye”infinitely far away.”
4. Eyes can work effectively in a range of light intensity of approximately 10¹⁰: 1, from noon until very light very dark night.
5. Eye has an automatic hole arrangement, namely the iris.
6. The cornea has an eraser line formed therein; though the cornea does not have blood supplier of the cornea is made from living cells and can repair local damage.
7. Eyes have self-regulating system pressure to maintain the internal pressure of approximately 20 mmHg which maintain the shape of the eye. The eye quickly returns to its original shape.
8. Eyes are in a space that is shielded almost perfectly surrounded by bone, and the eyes are the fat pads that reduce shock strong.
9. Inverted shadow formed on the light-sensitive retina at the back of the eyeball (Figure 13.2) but the brain so that the image looks the same fix as the object upright.
10. Brain processes images from the two eyes, giving good depth perception and the actual three-dimensional view. If the sight of one eye is lost, sight of the other eye is quite adequate for most needs.
11. The muscles of the eye allow flexible movement up and down, left and right side, and diagonally, as shown in Figure 13.4.

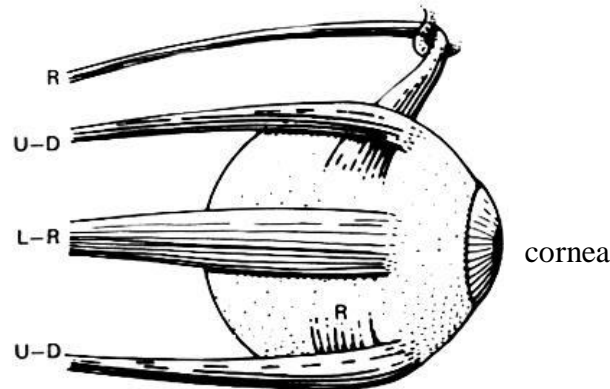

Figure 13.4. Six right eye muscles allowing broad types of movement. Muscle work in pairs: a pair of controlling movements upwards and downwards (UD), a pair of motion control to the left and to the right (LR) and a pair of rotational motion control R. Muscle rotation passes through loop-loop reinforced. Six muscles were all attached to the skull behind the eyes (Cameron, 1978: 340).

Having regard to the sophistication of the eye mechanism, most people have good eyesight. These people are called emmetrope, but we must be careful to use the term. Some people have vision imperfections that need to be considered and called ametropes. If we assume an emmetrope is anyone who needs a correction of less than 0.5 diopters, 25% of young adults were eligible; 135% are within range of ± 1.0 diopters. Many medical specialists associated with the eye. Most physicians require education and

training is an eye doctor (ophthalmologists). They are entitled to diagnose and treat any eye problems. Their treatment including surgery. The most common eye specialist is an optometrist, who specializes in setting and adjusting the auxiliary lens. They were not given permission to treat eye diseases. Optician (optician) is a specialist in making lenses, lenses match the frame, and the frame match with the patient. Orthopist are technicians who deal with eye muscle control and the problems associated with this control as crossed eyes.

C. Eye on The Focused Elements

Eye has two main focused components, namely the cornea and lens. Curvature of the cornea which is the transparent and clear on the front of the eye that do roughly two-thirds of the focusing. The lens is the part of the eye do fine focusing. The cornea is an element fixed focus, while the lens is an element that has the shape can change and have the ability to focus on objects at various distances.

The cornea focuses the light rays refract. Large refraction depends on the curvature of the surface and the speed of light in the lens compared to the speed of light in the surrounding material (relative refractive index). The refractive index of the cornea and other parts of the eye transparent given in Table 13.1. When in the water most of the cornea loses power focused because the refractive index of water (1.33) approach the corneal refractive index (1.37). The divers maintaining the air around the cornea with a mask (mask). The refractive index for all cornea is almost constant, but the curvature varies greatly from one person to another. Curvature of the cornea is what plays a role in visual impairments. If the cornea is too curved, near sighted eyes. If the cornea is less curved, far sighted eyes, and uneven curvature of the cornea produce astigmatism. Almost all by focusing on the front surface of the cornea is done because the aqueous humor in contact with the rear surface has a refractive index similar to the refractive index of the cornea.

Table 13.1.

The refractive index of the cornea and other parts of the eye.

Part Eyes	Refractive index
Cornea	1,37
Aqueous humor	1,33
Sheath lenses	1,38
Lens center	1,41
Vireous humor	1,33

Because of the living cells in the cornea of oxygen supplied by the blood, the cells must obtain oxygen from the air. Blood vessels in the cornea vision will not help us. Nutrients to the cells in the cornea is given by the aqueous humor in contact with the rear surface. Aqueous humor contains all the components of blood except blood cells. If the cornea unstability cornea will heal by itself, but some other kind of damage is more permanent. Some types of radiation include: ultraviolet, neutrons, x-rays can cause

corneal haziness that will thrive in the light blocking. Now it is possible to do using a corneal transplant from a donor who was taken immediately after death. Because corneal cells have a low metabolic rate, rejection is usually not of rejection in organ transplantation most other transparent.

The lens has focused properties and surface to the front surface of the back. The lens is more curved backwards rather than forwards. Changing the focusing power of the lens by changing the curvature. Focus less power than focusing power of the cornea because the lens is surrounded by substances that have a refractive index approaches the refractive index (Table 13.1). Therefore, the effective refractive index is 1.07. The lens is made of layers of the onion -like, and all the layers do not have the same refractive index. The refractive index in Table 13.1 is the average value.

The lens has a flexible sheath which is supported under mounting stress fibers. When muscle tension is loosened focused eye lens is rather flat and set its lowest, and eyes focused on distant objects. The point at which distant objects are focused when the muscle is relaxed focused called distant point. For near-sighted people away point may be quite close to the eye. To focus on nearer objects, the ring of muscle around the lens to contract into a smaller circle and take some or all of the lens voltages. The lens becomes more rounded out, mainly by being more curved in front. Therefore, the lens has a focal power greater; objects closer to the eye is focused on the retina. Nearest point where the objects can be focused when the lens is in a state called the thickest point near. Teenagers have the most flexible lens and can focus on objects that are very close. The ability to change the focal power of the eye is called accommodation. As long as people grow to be older, her eyes los of lens accommodation. Presbiopi (old eyes) produced when the lens of the eye has lost almost all of her accommodation.

Such as the cornea, the eye's lens can be damaged by ultraviolet radiation or other radiation. It can develop into a cataract, which is damaging clarity. It is possible to eliminate damage to the eye lens and adding additional repair surgery with lens.

D. Eye on Some Other Elements

The elements discussed here are the elements that are not directly involved in the focusing image or play a passive role in focusing. The retina plays such a dominant role in the function of the eye and are discussed separately. The components that we are talking about here is the iris and the pupil, the aqueous and vitreous humors, the placement of the eye, the sclera.

The pupil is a hole in the center of the iris in the lens where light enters. The pupil appears black because basically all the incoming light is absorbed in the eye. Under average light conditions, the hole diameter of approximately 4 mm. The diameter of the hole can be changed from approximately 3 mm in bright light until about 8 mm in dim light. This state of physiological reasons are not clear. The maximum changes by a factor of 7 in the opening area can not begin to cover a large range of light intensities that can be taken care of eyes, 1010:1. Iris does not respond instantaneously to changes in light level, approximately 300 second required for the iris to open fully, and approximately 5 second needed to close.

It is believed that the iris helps the eye by raising or lowering the light on the retina to retina has adapted the new lighting conditions. In addition, under bright light conditions the iris plays an important role in reducing lens defects. Camera enthusiasts will realize that the small holes increase the depth of focus, which is the range of distance in which objects are in focus satisfactory.

Aqueous humor fills the space between the lens and the cornea. This fluid, mostly water, is produced continuously, the excess will escape through the discharge vessel, Schlemm's canal. Discharge vessel closure produces an increase in eye pressure; condition is called glaucoma. Aqueous humor contains a lot of blood components and provide nutrients to the cornea and lens. Aqueous humor maintains eye pressure at approximately 20 mm Hg. If you press your eyes, you get a little lumpy; You can not damaged further. The reason is that the fluid in the eye is unpressure on the pressure you use and that the coating of the eyeball does not creep easily. When you are scratching your eyes, you increase the pressure in the eye is quite large.

The vitreous humor is a jelly-like substance that fills most of the clear space between the lens and the retina space. Vitreous humor helps in maintaining the shape of the eye that is basically fixed and permanent. The vitreous humor is sometimes called the vitreous body.

Sclera is the tough membrane, white, and meetings that envelops the entire eye except the cornea. Sclera is protected by a transparent layer called conjunctiva (conjunctiva).

E. Retina

The retina contains photoreceptor cells that is associated with a complex network of neurons and nerve fibers connected to the brain via the optic nerve. Consider Figure 13:5. Light absorbed by photoreceptors generate nerve impulses that propagate along the nerve tissue and then through the optic nerve to the brain. Photoreceptors are behind the neural network, then the light must pass through the cell layers before reaching the photoreceptors.

The retina is the light sensitive part that converts the light image into nerve impulses that send to the brain. While the role of the retina similar to film in a camera, a better analogy is between the retina and the light-sensitive part of a TV camera tube. Unlike the film, the retina does not have to be replaced because of a system in which giving chemicals sensitive to light that converts light into electrical impulses. We do not completely understand the mechanisms involved in the retina, but we know a lot of the characteristics of the photoreceptors in the retina via the physical aspect.

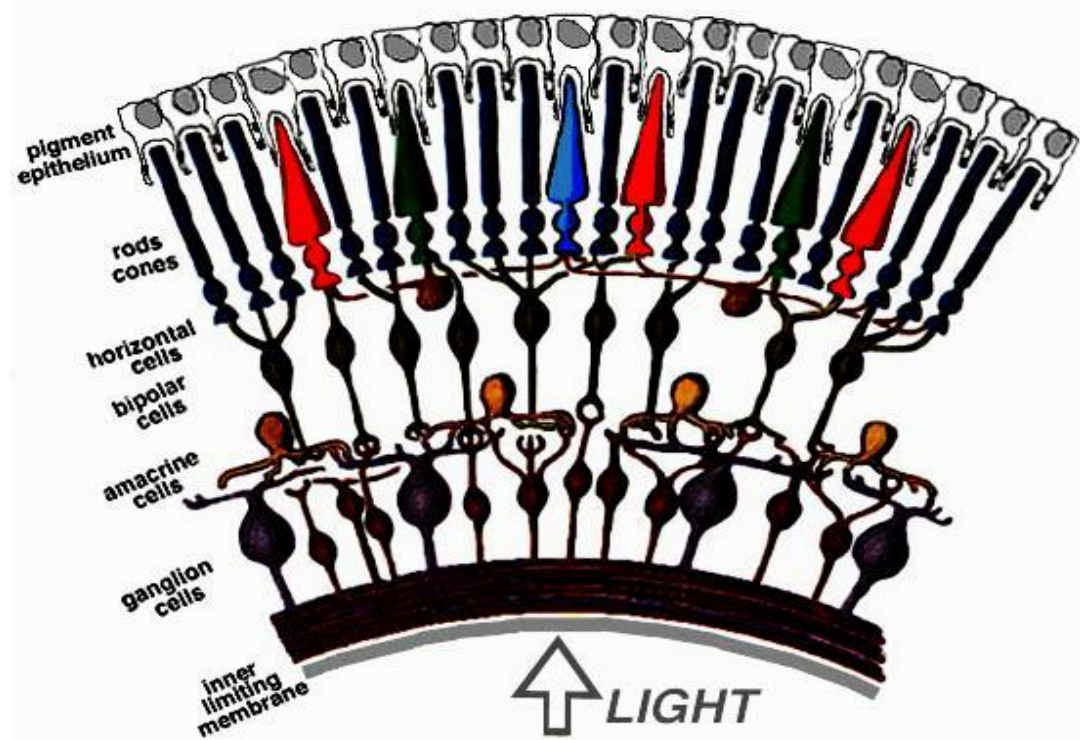

Figure 13:15. Structure of Retina (Davidovits, 2001: 208).

The absorption of a photon of light in photoreceptors triggers electrical signals to the brain, namely the action potential. The photon energy of about 3 eV; action potential energy has millions of times larger. Fotocahaya cause photochemical reactions in a way that photoreceptors initiate an action potential. The photon must be above the minimum energy to cause the reaction. Infrared photons do not have enough energy and not visible. Ultraviolet photons have enough energy, but the photons that are absorbed before reaching the retina and is also not visible.

Retina envelops the back half of the eyeball. Most of vision is limited to a small area called the macula lutea or yellow spots. Vision of the small parts of objects occurs in a very small area in the yellow spots called the fovea centralis (central fovea). Shadows on the retina is very small. In Physics course you have learned about geometric optics discuss the formation of a shadow by the lens. Distance of the object's shadow and distance s' is connected to a thin lens of focal length f by the formula

$$\frac{1}{s'} + \frac{1}{s} = \frac{1}{f} \quad \dots (13.3)$$

For objects or shadows or s' adalah s real positive sign and to mark objects or virtual image s or s' is negative. For convex lenses (including eye) f is a positive sign. Linear magnification m for thin lenses follow the formula

$$m = \frac{h'}{h} = -\frac{s'}{s} \quad \dots (13.4)$$

where h is the height of the shadow and h is the height of the object. Magnification m is positive if the same image with the object upright and negative if inverted image of the object.

Example 13.2:

How tall shadow on the retina a physics teacher students, if the teacher's height is 1.13 m and 4.0 m standing in front of the students in the class? Eyepiece distance to the student retina is 2.0 cm.

Completion:

$$\frac{h'}{1,6 \text{ m}} = -\frac{2,0 \text{ cm}}{4,0 \text{ m}}$$

$$h' = -\frac{(2,0 \text{ cm})(1,6 \text{ m})}{4,0 \text{ m}} = -0,80 \text{ cm}$$

So tall shadow on the retina is 0.80 cm and inverted.

There are two types of photoreceptors in the retina, the cone (cone) and a rod (rod). In the majority of retinal cones and rods are not on the front surface of the retina but is located behind several layers of neural tissue through which light (Figure 13.15). However, in the fovea centralis most of this neural network is pushed to the side and there is a little hole (hole means the fovea). Decreased vision neural network helps us in the specified area. Rods and cones distributed symmetrically in all directions of the axis of vision except in one area, namely the blind spots.

Cone (approximately 13.5 million in each eye), or photopic, mainly used for daytime vision. With the cone we can see the small parts are smooth and recognize different colors. Cones in the fovea centralis mainly found, although there are a few scattered throughout the retina. Each cone in the fovea has a "telephone network" itself to the brain. At some residual retinal cones merge into a single nerve fiber. The cones are not uniformly sensitive to all colors but has a maximum sensitivity at approximately 550 nm in the yellow-green region. It is very consistent to the maximum in the solar spectrum at the earth's surface.

Rod, or scotopic, used for night vision and peripheral vision. Stems much more than cones (about 120 million in each eye) and close most of the retina. Stems are not uniformly distributed on the retina but has a maximum density at an angle of approximately 20°. Thus, if you look into the sky at night, the light of a dim star that shifted 20° from the line of sight you will fall on the most sensitive area of your retina. If you look directly at a dim star, its shadow will fall on the fovea of you who do not have a rod and you will not see it.

Histological studies have shown that hundreds of rods transmit the information to the same nerve fibers. This means that the ability to separate two adjacent light sources in the peripheral vision is poor. In contrast, the sensitivity of a large trunk and a large expansion allows us to recognize objects that approach the object from the side when we look straight ahead.

Rods are most sensitive to blue light (approximately 410 nm), which has a shorter wavelength than the optimum cone (approximately 550 nm). Rods and cones are equally sensitive to red light (650 to 700 nm).

Eyes do not have the greatest sensitivity to light under conditions photopic. If the light level suddenly drops by a factor of 1000 while we were "in the dark," but after a few minutes we were able to see a lot of small parts that do not appear when the first becomes dark. The dark adaptation is the time it takes for the body to increase the supply of chemicals to the photosensitive rods and cones. Cones adapt most quickly, after about 5 minutes the fovea centralis best sensitivity. Rod dark adaptation continued for 30 to 130 minutes, although most of the adaptation occurs in the first 5 minutes. It is possible for dark adaptation by using red goggles that restrict the light coming into the red region of the spectrum. You can adapt the dark with one eye shut; case is useful for example when you enter a dark movie theater.

It should be noted that there was an area of approximately 130 to 180 which has no rods or cones, ie blind spots. This is the point where the optic nerve enters the eye. The blind spot was on the side toward the nose: if a shadow falls on the blind spot in one eye shadow was not caught on the other eye. We are usually not aware of the blind spots, but it is easy to demonstrate.

F. Threshold of Sight

Senses of vision occurs when light is absorbed by the light-sensitive rods and cones. At low light levels, rod photoreceptors are optimum. Light produces chemical changes in the photoreceptors that reduce sensitivity. For maximum sensitivity of the eye must be maintained for approximately 30 minutes to restore photoreceptor.

In optimum conditions, the eye is a very sensitive light detector. For example, the human eye respond to light of a candle as far as 20 miles. On the threshold of vision, the light intensity is so small that we have to describe the photon. Experiments showed that the photoreceptors (rods) the individual is sensitive to 1 quantum of light. However, this does not mean that the eye can see a single photon that comes on the cornea. At such low light levels, the process of vision is a statistic.

Measurements showed that approximately 130 quanta should come to the cornea for the eye to feel a glint. Approximately half of the light is absorbed or reflected by the medium of the eye. Therefore, approximately 30 photons that reach the retina scattered throughout the area that contains approximately 50 stems. Estimated only 5 of these photons are completely absorbed by the rods. Therefore, at least 5 must be stimulated photoreceptors to sense light.

Single photon energy is very small. For green light with a wavelength of 500 nm, energy is

$$E = hf = \frac{hc}{\lambda} = \frac{6,63 \times 10^{-34} \text{ J}\cdot\text{s}(3,0 \times 10^8 \text{ m/s})}{5,0 \times 10^{-7} \text{ m}} = 3,98 \times 10^{-19} \text{ J}$$

However, the amount of energy is enough to initiate chemical changes within a single molecule which then triggers rangkaian events that lead to the generation of nerve impulses.

In 1942, Hecht, Schlaer, and Pienne published important experimental results on the sensitivity of the rod. The initial question posed initially Hecht, et al. Is: What is the minimum number of photons that would produce the feeling of vision of at least 130 % of the time? To obtain the minimum amount, they have to optimize their experimental conditions. They must determine (1) the optimum color to use in a flash test, (2) the location of the most sensitive in the eye, (3) the best diameter used in the flash, and (4) the length of time that is best used in a flash it. They obtained the following answers: (1) the rod is most sensitive at 510 nm, (2) the most abundant stem at approximately 20o from the axis of vision, (3) does not depend keterdeteksi flashes diameter to 10'arc, while above this size more much light is needed for detection, and (4) for a flash of time up to approximately 0.1 s length does not affect keterdeteksiannya flashes, but for a longer time is needed more light.

The final results of their experiments showed that if about 90 photons entering the eye under the terms of the optimum, the flash seems 130 % of the time. When these investigators noticed all of the light is lost in the eyes, they estimate that only 10 % were completely absorbed in the trunk. Because the light is distributed to approximately 350 rods, they feel it is unlikely that a single rod receiving more than one photon. Therefore, they established that a single photon can activate a single trunk. The next experiment shows that as many as two photons are absorbed in the rods can provide visual signals. For comparison, a flashlight emits approximately 1018 photons per second.

You may be surprised to know that if 90 photons entering the eye, 10 photons or less is actually absorbed in the photoreceptors. What happened to the other photon? Approximately 3 % is reflected to the corneal surface, and approximately 50 % is absorbed in the various structures (cornea, lens, humor). Of the photons that reach the trunk area, only approximately 20 % (approximately 10 % of the original amount) is absorbed in the trunk. Photons that are not absorbed in the rods caught"anchoring."Some animals, like cats, have a reflective layer behind the stem which gives an opportunity to the other rod to absorb photons. These animals have eyes that"glow in the dark"if the light shone.

G. EYE ON THE EFFECT OF DIFFRACTION

All the diffraction of light experienced during the light passes through a small hole. In this case the spread of light around the edges of the hole. As a result, the light is not focused on a sharp point but become the diffraction pattern consists of a central bright maximum disc (called the diffraction spots or Airy disc) surrounded by bright rings with diminishing intensity and interspersed with dark rings. Because the lens has a rim, the lens

also works as a hole. When the lens to form the image of a point object, the shadow of that point is actually a small diffraction pattern. Center has a maximum width of half- angle θ

$$\theta = \frac{1,22\lambda}{d} \quad \dots (13.5)$$

with λ is the wavelength of light and d is the diameter of the hole. Stretch of the angle θ is expressed in radians ($1 \text{ rad} = 57.3^\circ$). Consider figure 13.6. Factor of 1.22 comes from the fact that the width of the circle hole is not uniform but varies from zero to its diameter d . Careful analysis shows that the average width is $\frac{d}{1,22}$.

Iris also produce a diffraction pattern on the retina (Figure 13.7). In normal pupillary aperture (about 4 mm) of these symptoms do not have practical effect on the activities of daily vision. However, if the pupil becomes much smaller, for example 1.0 mm, diffraction produces an effect on visual acuity (visual aquity).

All lenses have a disability (aberration). The influence of such an aberration is reduced if the lens aperture is made smaller. In the eye, the pupil small repair visual acuity. However, if the pupil is made very small acuity becomes worse due to diffraction effect. There is an optimum size for the pupil; acuity obtained best for emmetropic eye with pupil size of 3 to 4 mm below the normal size good lighting.

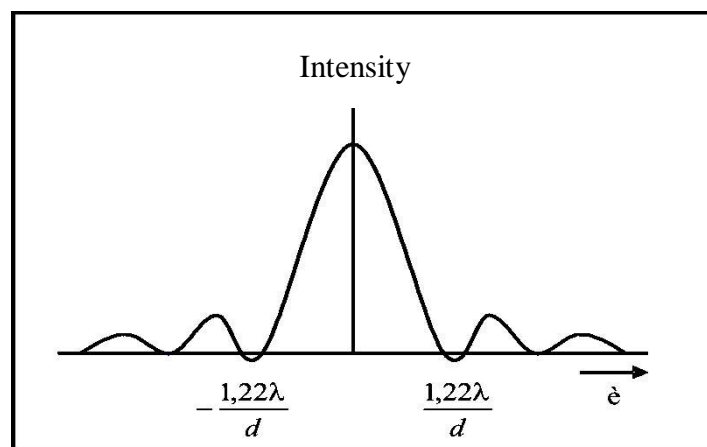

Figure 13.113. The light intensity at the diffraction pattern of a round hole.

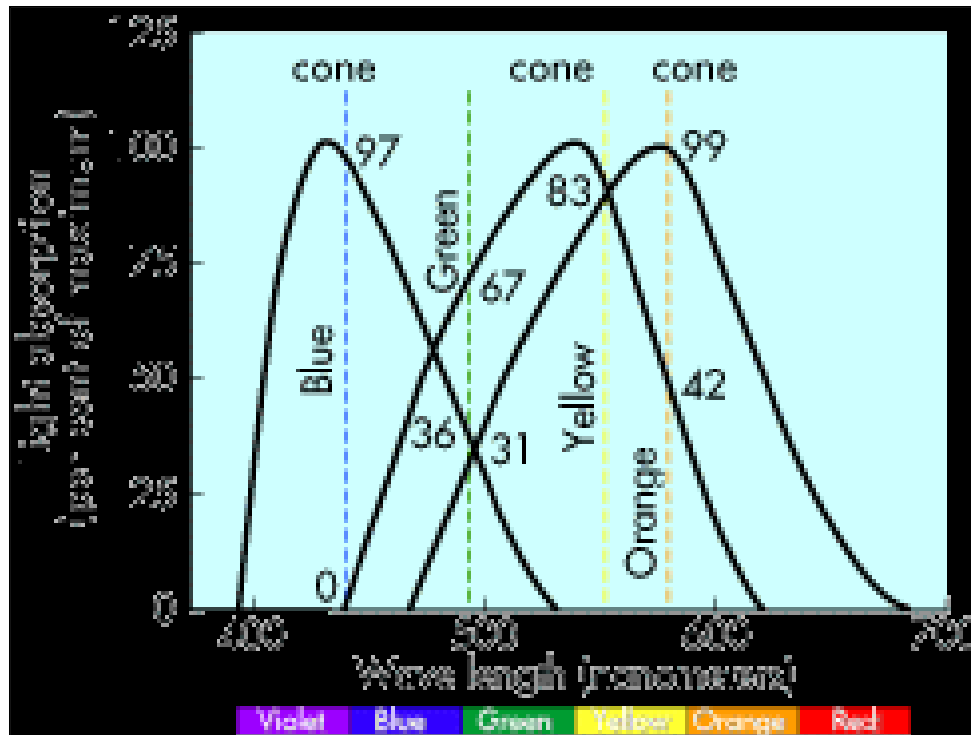

Figure 13.17. Diffraction in the eye. (a) monochromatic light from a distant point source brought to a focus on the fovea centralis in the retina. (b) The diffraction pattern on the retina produced by the pupil diameter of 3.0 mm consists of a central bright spots 8 μm in diameter surrounded by a ring of light with reduced intensity (Cameron, 1978: 351).

Example 13.3:

Calculate the angle and diameter stretch of bright spots in the center of the retina to light with $\lambda = 555 \text{ nm}$, if the pupil has a diameter of 3.0 mm.

Completion:

Using equation (13.5) we obtain

$$2\theta = \frac{2(1,22)(555 \times 10^{-9})\text{m}}{3,0 \times 10^{-3}\text{m}} = 4,5 \times 10^{-4} \text{radian}$$

For small angles, the diameter of the central bright spots is the product of the stretch of the angle and the distance between the pupil and the retina (17 mm) or $(4.5 \times 10^{-4})(17 \text{ mm}) = 7.135 \times 10^{-3} \text{ mm}$.

H. Acumen Eye

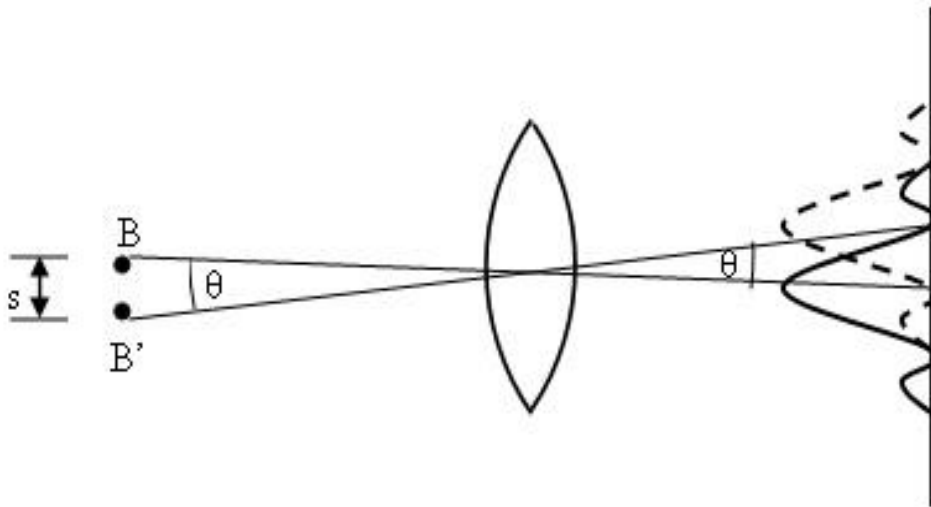

Figure 13.8. Rayleigh criterion. Two point objects B and B' form angle θ on the lens: for each point of the object depicted only to indicate the central ray diffraction patterns of shadow.

Two points can be separated if the object right corner $\theta = \frac{1,22\lambda}{d}$.

If the light comes from two point objects adjacent to one another, reflection diffraction discs overlap, making it impossible to distinguish the two point objects. Lord Rayleigh (1842-1919) suggested criterion which states that two right shadow can be separated when the central maximum of the diffraction pattern from one image directly above the first minimum in the diffraction pattern of the second shadow. 13:18 Look at the picture. Since the first minimum is at a maximum angle $\theta = \frac{1,22\lambda}{d}$ of diffraction pattern center, then two things can be said right can be separated if they are separated at an angle

$$\theta = \frac{1,22\lambda}{d} \quad \dots (13.13)$$

It is a separation of the boundary formed by the wave nature of light due to diffraction. Usually simpler expressed in distance between the two objects or two shadows of the angle formed by it, namely image distance s in 13:18. This distance is often called a split lens power is concerned. For small angles, the separation of power is equal to the angle multiplied by the distance of two objects or two shadows into the lens. Separation power of the human eye is limited by several factors. The separation power of the best in the fovea, where the cone is the smallest separator, approximately 3 lm. Pupil diameter varies from 3 mm to 8 mm. For $\lambda = 550$ nm, diffraction limit of up to approx.

Eye length is approximately 2.0 cm, so that the angle corresponding to the power split up. Spherical aberration and chromatic eye also limit the power split is approximately 10 lm. Eyes can separate objects that have a separation angle of approximately radians.

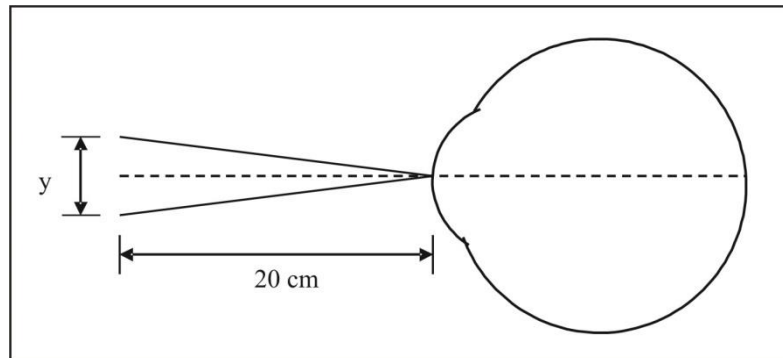

Figure 13.19. Power split eye.

Let us now calculate the size of the smallest object that can be separated by eye without the aid of tools. To observe the smallest part, the object must be taken to the nearest point where the eye can focus it. Suppose that the distance is 20 cm from the eye, the angle formed by two separate points at a distance y (see Figure 13:19) is determined by

$$\tan^{-1} \frac{\theta}{2} = \frac{y/2}{20} \quad \dots (13.7)$$

If the angle θ is very small, then the tangent of the angle approaches the angle itself (in radians) so that we can write

$$\theta = \frac{y}{20} \quad \dots (13.8)$$

Due to the separation of the smallest angle of the eye is radians, then the power split is the smallest part of the object

$$y = 5,0 \times 10^{-4} \times 20 \text{ cm} = 0,01 \text{ cm} = 0,1 \text{ mm}$$

Eye chart, which is commonly used to determine whether we need the auxiliary lens, can be used to test the properties of our eyes called visual acuity. Physicists refer to this as the separation of visual acuity (resolution) of the eye. Visual acuity is the sharpness of the small parts of objects that can be detected by eye. Test vision, such as reading the rows of letters on the chart, assume that a particular acuity is normal. Eye patients were tested against these norms to determine whether vision correction is necessary.

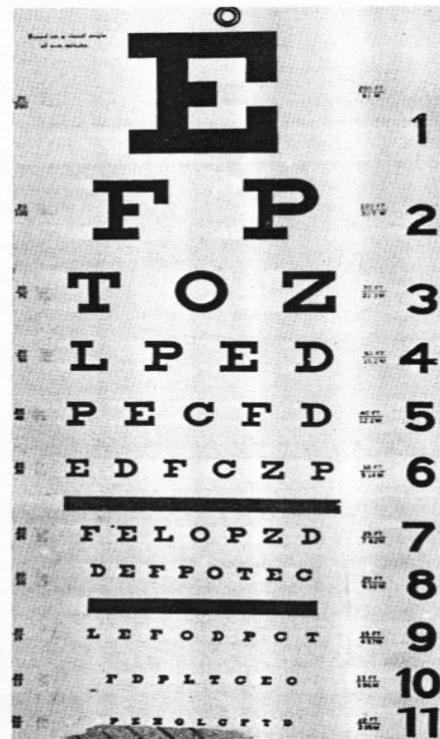

Figure 13.20. Snellen chart for vision testing is typically viewed from 20 ft. Line 20/20 is the number 8. The rows that form the letters have a wide angle of 1° arc at 20 ft. Some letters, such as L, it is easier to remember than the other letters, such as B and H (Cameron, 1978: 353).

To test acuity Snellen eye chart is usually used (Figure 13.20). If the test results stating that your normal eye test at 20/20, meaning that you can read in detail from 20 ft sighted people who can read well from 20 ft. If your eye test on 20/40, you can only read from 20 ft. line that sighted people can read better than 40 ft.

Acuity or eye separation is mainly determined by the cones in the fovea karaketristik. The common way to test the power split is a pattern of alternating black and white are becoming increasingly narrow. Combined the white line and a black line called the line pair (lp = a line pair). Under optimum conditions, the eye can separate as separate lines of a pattern of about 30 lp / mm, if the eye is at a distance twice as far away, the eyes can only separate the 15 lp / mm. Separation is also often expressed in the angle formed by the eye. This angle is approximately independent of viewing distance. The minimum angle between two black lines that can be seen separately is approximately 0.3 milliradian. To be seen separately, the two lines must occur in rows of alternating cones so that the space between the pylons visible white strip (Figure 13:21). The smallest black dots that you can see under optimum conditions is 2.3×10^{-13} radians. Separation quickly becomes worse during the shadow moves away from the fovea centralis. At 10° of the fovea acuity becomes worse by a factor of 10. If the lighting is not optimum separation is also reduced.

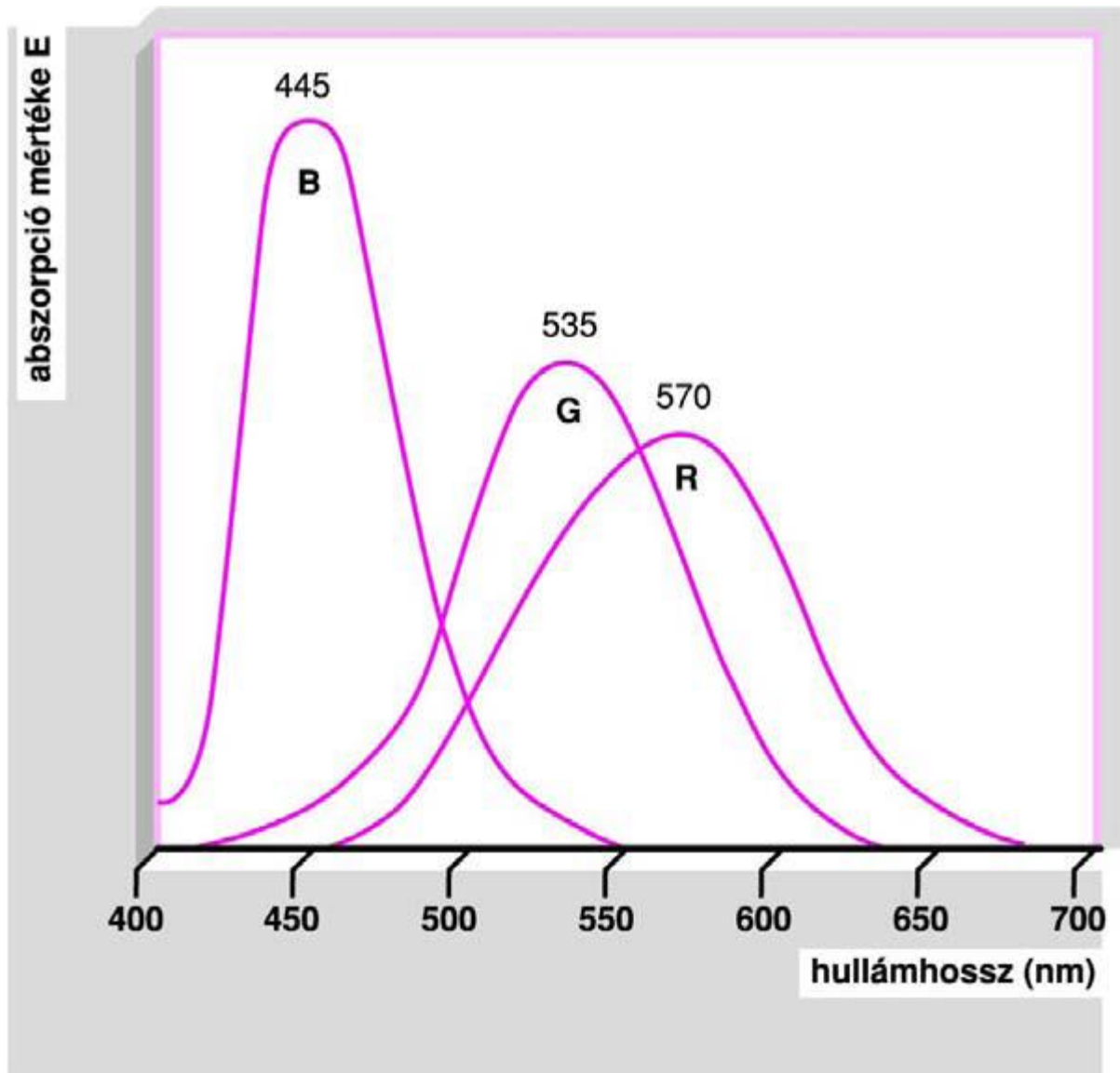

Figure 13:21. To look closely spaced lines (a) separately, shadow lines that need to fall on lines alternately from the pylons as shown in the chart in (b). All cones that receive light (c), but more that falls on a cone-cone corresponding to the rows of white (Cameron, 1978: 354).

Separation of light over darkness is about 10^{-3} radians the arc, while the separation of the light is dark above about 3.9×10^{-4} radians. This means that both eyes will only read 20/130 on the Snellen chart if the chart was created in light-on-dark-over. This fact is of practical importance in the manufacture of projection slides for lectures; bright letters on a dark background is not easy to read as dark letters on a light background. The ability of the eye to recognize the separate lines also depends on the "black" or "whiteness" is relatively the lines. Separation much worse if the lines are two shadows adjacent gray than if the line is black and one is white line. The contrast between the two regions C is defined as

$$C = \frac{I_1 - I_2}{I_1 + I_2} \quad \dots (13.9)$$

I_1 and I_2 are the light intensities of the two regions. Low contrast between the two areas noted on the x-rays are often severely limits the usefulness of x-rays. We need to define a unit for measuring the "darkness" x-ray films or other optical absorber. Meetings optical (OD = optical density) is defined as

$$OD = \log \frac{I_0}{I} \quad \dots (13:10)$$

with I_0 is the intensity of light without absorbing light and I is the intensity of the absorber. For example, a piece of film that 19 % continue to have meetings optical light coming $OD = \log (1 / 0, 1) = \log 10 = 1.0$. The film which absorbs 99 % of light having optical meeting $OD = \log (1 / 0, 01) = \log 100 = 2.0$.

I. Sight and Disability His Help

Before we talk about eye defects we consider again equation (13.3). If the focus distance is expressed in meters, then the power of the lens

$$P = \frac{1}{f} \quad \dots (13:11)$$

expressed in D (diopters). If a positive lens (convex) which has a focal distance of 0.1 m, then the lens has a power of $P = 1 / (0.1 \text{ m}) = 10 \text{ D}$. If a negative lens (concave) which has a focal distance of 0.5 m, then the lens has a power of $P = 1 / (-0.5 \text{ m}) = -2 \text{ D}$. Focal distance f from the combination of a thin lens with focal distance f_1 , f_2 , f_3 , and so on. determined by

$$\frac{1}{f} = \frac{1}{f_1} + \frac{1}{f_2} + \frac{1}{f_3} + \dots \quad \dots (13:12)$$

If each of these lenses have the power P_1 , P_2 , P_3 , and so on and expressed in diopters, the lens power P of the lens combination can be expressed as

$$P = P_1 + P_2 + P_3 + \dots \quad \dots (13:13)$$

Most of the refraction performed on the front surface of the cornea which has a refractive index of 1.3713. Worked as a regulator of smooth lens to focus at different distances. This is done by the ciliary muscles, which changes the completeness of the support so that the lens focus distance changes. To focus a distant object, it loosens the muscles and flattened lens, image 13.22 (a), and collects parallel rays at the focal point on the retina. To focus objects within close, the muscles contract which causes the center of the lens is thicker, picture 13:22 (b), shorten the focal distance so that shadows of objects within close can be focused on the retina at the back focal point. Setting the focus is called accommodation.

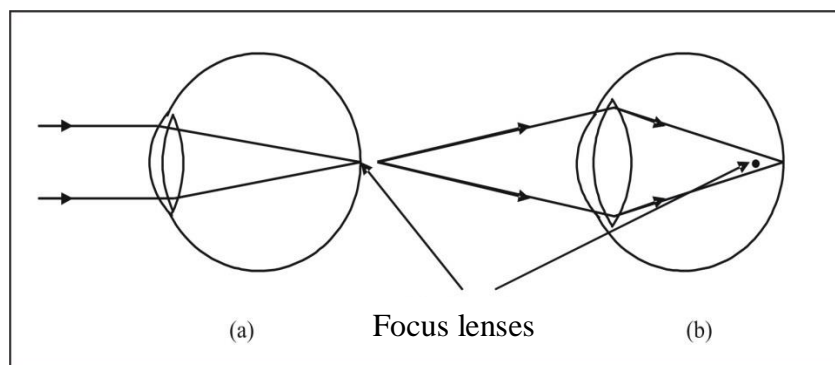

Figure 13.22. Accommodation normal eyes: (a) The lens of the eye 'relaxed' (eyes not accommodated), focused on infinity, and (b) thickened eyepiece (eye accommodation maximum), focusing on close objects.

The shortest distance at which objects can still be seen clearly eye called the near point. For adults it is typically near point is 25 cm. As long as humans grow older, the ability to accommodate reduced and a point near the eye increases. Point was the furthest away one that allows objects to be seen clearly. For some specific purpose we use the term normal eye, which is defined as having the eye near the point of 25 cm and an infinitely distant point.

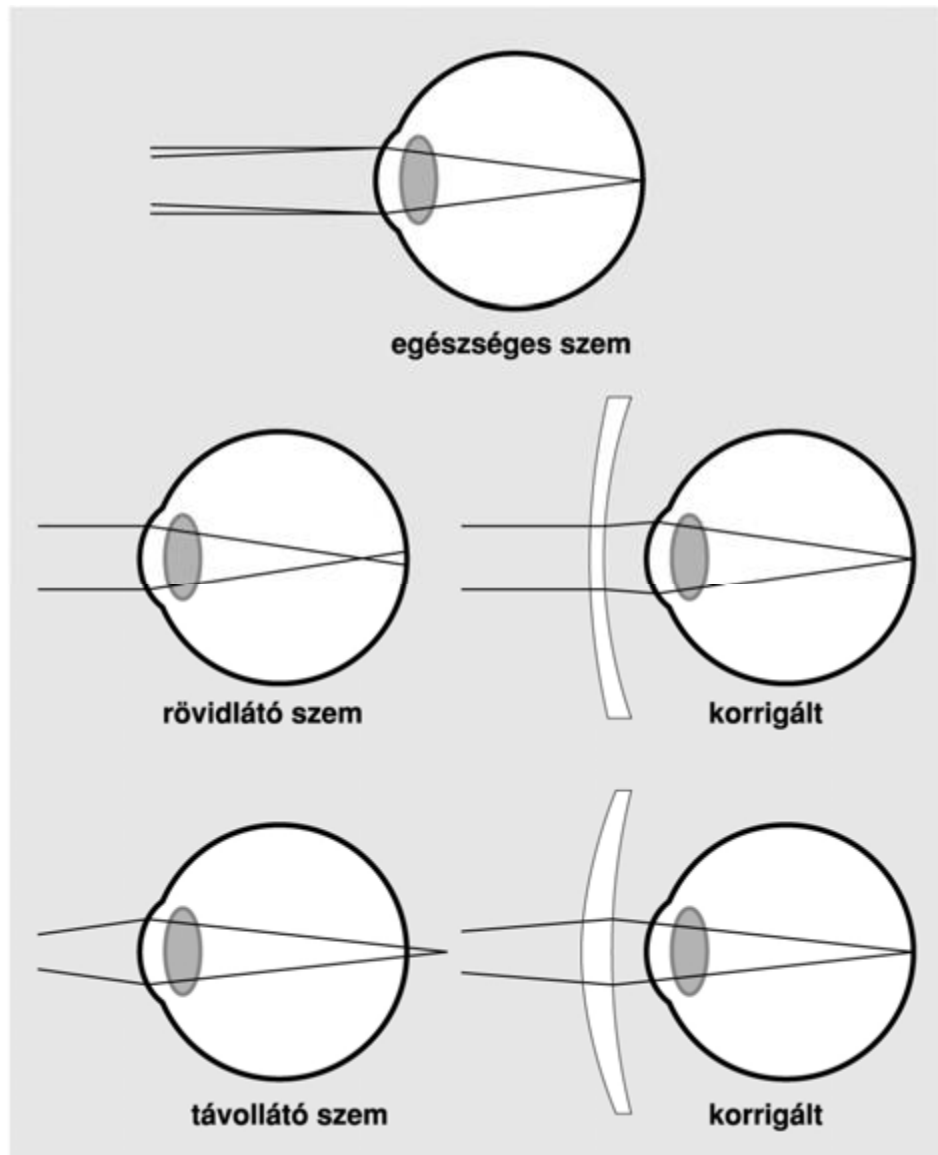

Figure 13:23. Chart of normal and defective focusing. The wavy lines indicate a blurred image on the retina (Cameron, 1978: 3135).

Eyes'normal'is an ideal. Most of the human population who do not have eyes berakomodasi within the normal range of 25 cm to infinity; otherwise handicapped person is said to have a vision. Defect of vision caused by the focusing lens of the eye is called ametropi. There are four types of ametropi, namely myopia (near vision), hiperopi or hipermetropi (far sight), astigmatism (asymmetry focusing), and presbiopi (old eyes). Figure 13:13. Various problems focusing and its characteristics are shown in Table 13.2. Near sighted person, or myopia usually have the eyeball is too long or the cornea is too curved. Distant objects are focused in front of the retina and spreads rays that will cause a blurred image on the retina. This visual impairments can be helped with a diverging lens, because the lens causes parallel rays spread, allowing the rays focused on the retina, as shown in Figure 13:14 (a).

Table 13.2. Summary of various problems focusing and its characteristics.

Focusing Issues	General name	Causes Commonly	Helped by
Myopia	Vision near	the eyeball is too long or the cornea curved	Negatively lens
hipermetropi or hiperopi	Vision far	short eyeball or cornea is not curved enough	positive lens
Astigmatism	-	the cornea curvature is not the same	cylindrical lens
Presbiopi	Vision old age	accommodation	Bifocus

Far sighted persons, or hiperopi, has a near point is more distant than the normal eye and need berakomodasi to see distant objects clearly. Although the objects within remote can be seen clearly, the nearby point somewhat larger than normal eyes of 25 cm, which makes it difficult to read the eye. This defect is usually caused by the eyeball is too short or the cornea is sometimes due to insufficient arch. This eye defect can be remedied with a converging lens, as shown in Figure 13:14 (b).

In the uneven curvature of the cornea astigmatism. Test astigmatism is seeing patterns of radial lines, as shown in Figure 13.15. Astigmatic eye will see the lines more clearly in the direction of the lines in the other direction. Astigmatism helped by using an asymmetric lens (cylindrical) with force in one direction is greater than the power in the direction perpendicular to it (Figure 13.16). Berpengelitan eye lens for near or far sighted and astigmatic also honed with the incorporation of spherical and cylindrical surfaces, so that the radius of curvature of the lens is different helper-objects in different places.

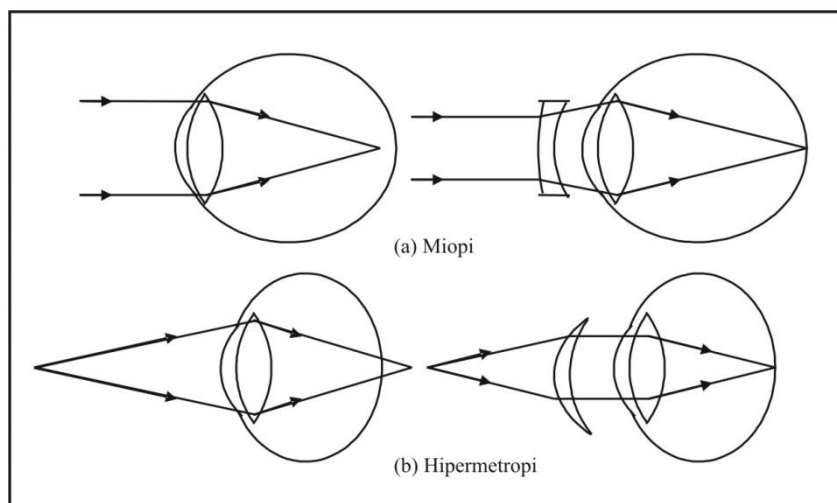

Figure 13:14. Helping with visual impairments: (a) a diverging lens for myopia eye, which can not focus clearly on distant objects, (b) converging lens to the eye hipermetropi, which can not focus clearly on near objects.

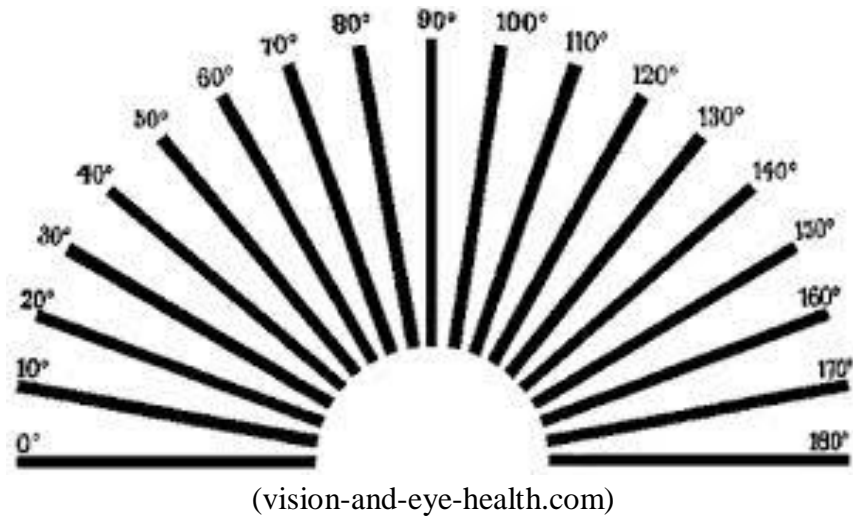

Figure 13.15. Simple test for astigmatism. Eye with astigmatism see the lines in one direction more clearly than lines in the other direction (Cameron, 1978: 3138).

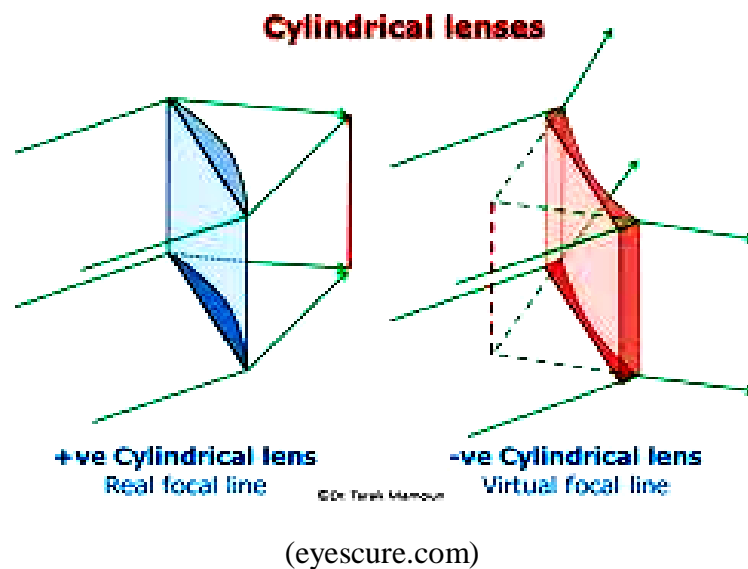

Figure 13.16. Astigmatism helped by adding a cylindrical lens on a spherical lens. The cylindrical lens may (a) converges, ie cylinder plus, or (b) diverges, ie minus cylinder (Cameron, 1978: 3139).

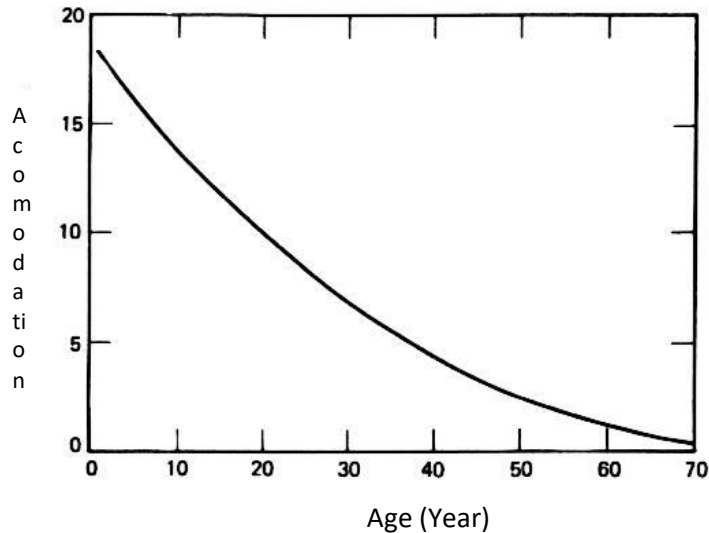

Figure 13.17. Loss of accommodation due to age. The decrease in accommodation usually become more observable after age 40 (Cameron, 1978: 3139).

Often parents have problems reading the small print when he distanced writing books of eyes look more vivid because the mold was too small for him to separate the letters. These people need reading glasses. If he has used to help handicapped vision goggles, he need glasses bifocus. The vision defects occur due to loss of accommodation for age (Figure 13:18). The lens becomes less flexible, and when the voltage on the eyes loosened, its size is only changed slightly.

If we want to wear glasses helper, we should bring the recipe. One recipe reads as follows.

	Sphere	Cylinder	Axis	Add
O.D.	-4,25	-1,25	180	+1,50
O.S	-4,50	-1,75	160	+1,50

This means that the right eye (OD) -4.25 D spherical lens needs to be added to the cylindrical lens-1, 25 in the horizontal plane (180o). Bifocus read in part, +1.50 spherical lens is added to the recipe. Recipes for the left eye (OD) is interpreted in a similar way.

Because technology is developing rapidly, glasses can be replaced with contact lenses made of plastic. Contact lenses are mounted on a thin layer of tears on the cornea at the front, one of the most sensitive parts of the body. Even teenagers use contact lenses for cosmetic reasons. In the world of sports like sebakbola, there are players who use contact lenses due to safety reasons. Disadvantages of contact lenses, among others, (a) more expensive than glasses, (b) require routine cleaning procedures, and (3) is not used to help astigmatism.

From the point of view of physics, contact lenses perform the same function as glasses. However, the combination of the lens focusing power depends on the separation distance between lenses combined. Separation distance between the spectacles and the

cornea can be determined rather well with the construction of the handle glasses. Contact lens and cornea in direct contact, thus affecting the recipe. An original myopia using the glasses and contact lenses to peindah will require a weaker negative lens, and eye hiperopi require stronger positive lens. The size of the resulting image on the retina of different contact lens with image size produced by the glasses; shadow was greater in myopia and smaller in hiperopi. The use of contact lenses require more accommodation on myopia and fewer accommodations on hiperopi.

Example 13.4:

Suppose the object distance $s = +15$ cm for the converging lens of $f = 20$ cm. Then the thin lens equation becomes

$$1/(+15) + 1/s' = 1/20 \rightarrow 1/s' = 1/20 - 1/15 = -1/60 \text{ and } s' = -60 \text{ cm.}$$

The - sign for s' means that the image is *virtual* (on the same side of the lens as the object, impossible to view or measure on a screen). The magnification is $m = -s'/s = -(-60)/(+20) = +3$. The + sign for m here means that the image is upright. We see that converging lens can give both real and virtual images, depending on the location of the object relative to the focal point.

Example 13.5

Suppose $f = (+) 20$ centimeters for the converging lens of figure 1 above. Then, if the object distance $s = + 30$ cm, the thin lens formula is

$$1/s + 1/s' = 1/f \quad 1/(+30) + 1/s' = 1/(+20),$$

$1/s' = 1/20 - 1/30 = 1/60$ and $s' = +60$ cm, where the plus sign for s' means the image is real and on the other side of the lens from the object.

The lateral magnification is $m = (\text{height of image}/\text{height of object}) = (h_i/h_o)$. In this case it is equal to $-(s'/s) = -60/30 = -2$, indicating an enlarged image. The minus sign for m means that the image is inverted. For a real image it is possible to place a screen at the focal plane and directly measure the height of the image.

J. Colour Vision

We already know that the visible light part of the spectrum of electromagnetic waves. Of long wavelength (low frequency) to the short wavelength (high frequency), visible light consists of red, orange, yellow, green, blue, and purple.

As has been discussed earlier that the light sensitive cells in the retina are rods and cones. Rods are more sensitive than cones and plays an important role in vision in extremely dark environments and peripheral vision. Rods scattered throughout the retina except the fovea centralis. Trunk does not produce the color information.

Cones are concentrated in the fovea and associated with color vision. There are three types of cones, each type is sensitive to a different wavelength range. Direct evidence of these three types of cone obtained from experiments difficult. Figure 13.29 shows the

absorption characteristics of the cone pigments. Indirect evidence includes the studies on the butawarna. Approximately 8 % of men and 1 % of women have partially color blind. Most of them only lose one type of cone, and various types of color blindness associated with the absence of cone types are different. There are very few people who lack the three types of cones and total color blindness.

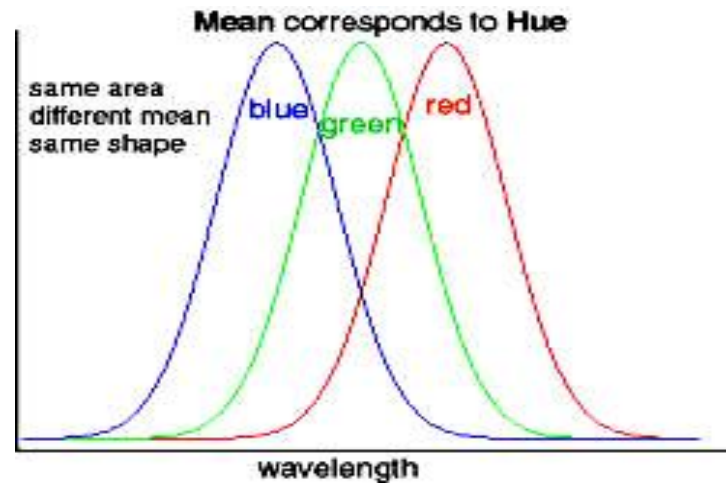

Figure 13.28. The relative sensitivity of the three types of cone indicated by the relative absorption as a function of frequency. The leftmost curve has been magnified by a factor of 8 in order to have the same height as the two curves to the right. Eye is less sensitive to short wavelengths than long wavelengths. Sensitivity curve similar to the trunks peaking at approximately 500 nm. Trunk is approximately 1,000 times more sensitive than cones.

Simple theory of color vision evolved initially assume that there are three main colors associated with the maximum sensitivity of the three types of cones. Hundreds of shades of colors that can be distinguished eye created by various stimuli in two or three types of cones. All shades of color can be generated by summing the three primary colors together with a variety of comparisons.

Such patterns are used in color televisions. The TV screen was covered with a colored phosphor dots of red, green, and blue with the same amount. These three colors associated with the maximum sensitivity of the three types of cones. A wide range of shades of color perceived by the audience, as the combination of dots of red, green, and blue lit. This range includes yellow, orange, purple, and many shades of other colors that are not in the rainbow, like the color of the meat tender and brown. No need to use dots of red, green, and blue colors to stimulate vision. Due to the sensitivity of the three types of cones are broad and overlapping, many sets of three different colors can be used to give the impression of hundreds of shades of color.

Characteristic cone proves that color vision associated with the wavelength of light, but it also proves that the characteristics of the relationship is not a simple relationship. Aspects of the three-color is set properly; theory more sophisticated does not reject, but rather extend it.

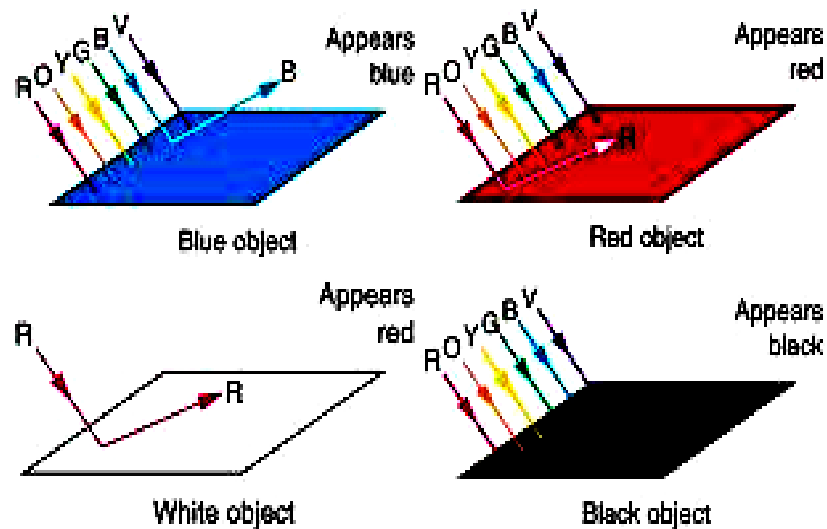

Figure 13.29. Absorption characteristics determine the actual color of an object (inkling.com).

Why objects and light sources exhibit color? This relates to three things, namely objects, light, and color constants. Absorption and reflection characteristics of a variety of different substances. Figure 13.30 shows the white light that falls on four different substances, one pure blue, a pure red, one pure white and one black. All wavelengths except blue light is absorbed by the blue substance, and all wavelengths except red is absorbed by the red substance. More complex color patterns created by various degrees of absorption. White objects reflect all wavelengths equally well and the black object absorbs all wavelengths. Gray is the absorption of most of all wavelengths. The actual color (true color) may be defined in more detail as the reflection characteristics of a substance.

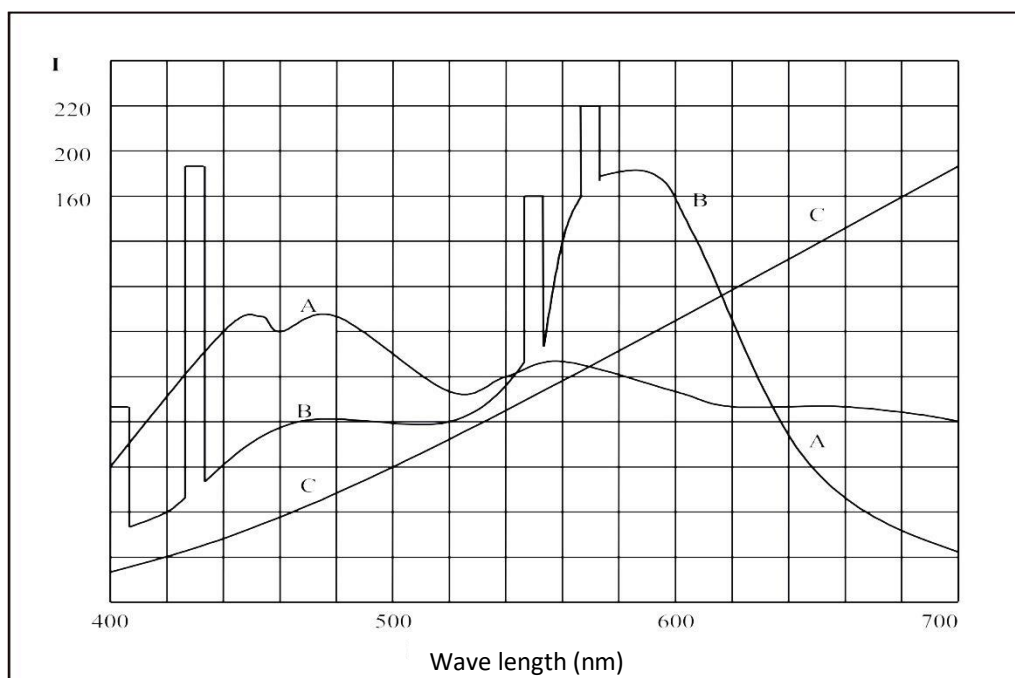

Figure 13.30. Graph of intensity against wavelength for three different light sources. A curve is the average sun light, curve B is the light of the lamp berfluor, and curve C is the light of incandescent bulbs. Eye is able to distinguish the true color of objects when irradiated with one of these sources. Sharp peaks of the curve B is the spectral lines of mercury.

The light source can be different colors if the light source emits only certain wavelengths of light. The sun emits a wavelength spectrum is broad, whereas incandescent lamps and light emitting berfluor different spectra can be observed. Consider Figure 13.30. We can estimate the objects appear different colors when illuminated by different light sources. For example, a white object will appear red when illuminated with red light. One thing that is remarkable about color vision is that one is able to see the true color of an object within a wide range of lighting conditions. For example, white tablecloths illuminated by the sun, incandescent, berfluor, or even light a candle that still looks yellowish white. This capability is called constant color (color constancy). Eye-brain system is the sense of the wavelength of the light it receives; system that compares the light of various objects and to the relative absorption of different wavelengths of light. The system was sensitive to the actual colors of objects compared to the wavelength and intensity just received.

Edwin H. Land did a lot of experimentation superior color vision. It helps quantify the color constant observation. Land looked at the color constants are important fundamental and forward the theory that takes into account the color constants corresponding to the unknown nature of color vision. Land theory, known as retineks theory, suggests that the cones do not operate completely independently but rather organized into three independent systems, one for each cone. The system is called retineks to indicate that the system involves the retina and cerebral cortex. Each retineks establish an independent picture of the field of view. Therefore, comparisons between retineks provide information needed to determine the actual color of the object. Striking experiments conducted by Land indicates retineksnya theory and filter existing theories. Two pictures taken in view of the black-and- white films, one with a red filter and a blue filter. Then slide the black -and-white photography results were projected and overlaid on the screen. It turns out that the black -and-white image generated. Then the red filter placed in front of the slides were taken with a red filter, and the shadow of the two overlapped on the screen. In place of the shadow of red, pink, and white, shadow suddenly appeared to the observer into full color. This demonstration gives confidence in the existence of red retineks system: we can surmise that retineks system is able to make sufficient comparisons of black-and- white images that overlap with the red -and-white picture to see the actual color. If the cones only respond to the wavelength and intensity of the receipt, the image will appear red, pink, and white, because red wavelengths are the most dominant.

EXERCISE

To improve your understanding of the material above, do the exercises below!

- 1) Calculate the power of the lens to see objects that are at a point close to the normal eye, which is 25 cm. Suppose it has eye-to-lens distance of 2.0 cm of normal retinal
- 2) A point has a far sighted near 2.0 m. What power lens is needed to help these people to be able to read comfortably at a distance of 25 cm. Suppose it has eye-to-lens distance retina is 2.0 cm
- 3) A patient is diagnosed to have a point close to 0.5 m, and he wants to be able to read at a distance of 25 cm. What is the accommodation and how the power of reading glasses lenses that should be used? Suppose it has eye-to-lens distance retina is 2.0 cm
- 4) The point of smallest black eye visible emmetrope is 2.3 10⁻¹³ radians. How cm this size when viewed at a distance of 25 cm?
- 5) Eye emmetrope accommodation has 3 D. If the distance of the lens-to-retina is 2.0 cm, what is the point of him?

Instructions to Answer Exercise

If you have difficulty in completing these exercises, consult the instructions for the completion of each of the following questions.

- 1) Use the equation (13.3) with $s = 25$ cm and $s' = 2.0$ cm.
- 2) Follow the steps in the completion of Example 13.4.
- 3) Once again follow the completion of the steps in Example 13.4.
- 4) Use the equation (13.8) by replacing the near point distance of 20 cm to 25 cm.
- 5) For long-distance power of the eye lens is

$$P_{\text{rileks}} = \frac{1}{\infty} + \frac{1}{0,02 \text{ m}} = 50 \text{ D}$$

3 D accommodation gives strength $P_{\text{acm}} = 53 \text{ D}$ lens on a nearby point. Use equation (13.3) to find a nearby point, with $s' = 0.02$ m and $1/f_{\text{acm}} = P_{\text{acm}}$.

RESUME

Vision is the human perception of light through the eye-brain system. Senses of vision consists of three main components, namely: (1) the eye focus an image of the object on the retina is sensitive to light, (2) a system of millions of nerve that carries information to the brain, and (3) visual cortex (the visual cortex) which is a part of the brain where all processes are formed vision.

The sense of sight is often analogous to a closed circuit color TV system. Analogous to a TV camera lens and eyepiece cornea; "signal cables" analogous to the optic nerve, and "monitor" analogous to the visual cortex.

Eye has two main focused components, namely the cornea and lens. Curvature of the cornea which is the transparent and clear on the front of the eye that do roughly two-thirds of the focusing. The lens is the part of the eye do fine focusing, which can change its shape so as to have the ability to focus objects at various distances. Two main focused produces an inverted image and scaled objects on the retina. Passive components focused others are iris and the pupil, the aqueous and vitreous humors, and sclera.

The retina contains photoreceptor cells that is associated with a complex network of neurons and nerve fibers connected to the brain via the optic nerve. Light absorbed by photoreceptors generate nerve impulses that propagate along the nerve tissue and then through the optic nerve to the brain. Photoreceptors in the retina are the rods and cones. Rods are used for night vision and peripheral vision. Cones used for vision during the day. Formulas shadow formation in thin lenses are usually used to analyze the formation of a shadow on the eyes. Distance of the object's shadow and distance s' associated with focal distance f by the formula

$$\frac{1}{s'} + \frac{1}{s} = \frac{1}{f}$$

Linear magnification m following the formula

$$m = \frac{h'}{h} = -\frac{s'}{s}$$

where h' is the image height and h is the height of objects. If the focus distance is expressed in meters, then the power of the lens

$$P = \frac{1}{f}$$

expressed in D (diopters). Focal distance f from the combination of a thin lens with focal distance f_1, f_2, f_3 , etc.. determined by

$$\frac{1}{f} = \frac{1}{f_1} + \frac{1}{f_2} + \frac{1}{f_3} + \dots$$

If each of these lenses have the power P_1, P_2, P_3 , and so on and expressed in diopters, the lens power P of the lens combination can be expressed as

$$P = P_1 + P_2 + P_3 + \dots$$

Light passes through the hole, including the pupil of the iris undergo diffraction. The diffraction pattern consists of a central maximum disc (called the Airy disc) surrounded by bright rings with diminishing intensity and interspersed with dark rings. Because the lens has a rim, the lens also works as a hole. Center has a maximum width of half- angle θ

$$\theta = \frac{1,22\lambda}{d}$$

with λ is the wavelength of light and d is the diameter of the hole. Power split eye with regard to the diffraction of light by the eye. Lord Rayleigh criterion suggests that states that two right shadow can be separated when the central maximum of the diffraction pattern from one image directly above the first minimum in the diffraction pattern of the second shadow. Power is also called a split eye eye acuity. Eye acuity was tested with Snellen chart. Two objects (or shadow) can be said right can be separated if

both separated at an angle $\theta = \frac{1,22\lambda}{d}$

Usually simpler expressed in distance between the two objects or two shadows than the angle formed by it. This distance is called the split lens power is concerned. For small angles, the separation of power is equal to the angle multiplied by the distance of two objects or two shadows into the lens.

The ability of the eye to recognize the separate lines also depends on the "black" or "whiteness" is relatively the lines. The contrast between the two regions C is defined as

$$C = \frac{I_1 - I_2}{I_1 + I_2}$$

I_1 and I_2 are the light intensities of the two regions.

Defect of vision caused by the focusing lens of the eye is called ametropi. There are four types of ametropi, namely myopia (near vision), hiperopi or hipermetropi (far sight), astigmatism (asymmetry focusing), and presbiopi (old eyes).

Myopia is generally caused by the eyeball is too long or the cornea curvature, which can be helped with a negative lens. Hiperopi usually caused short eyeball or cornea is not curved enough and helped by a positive lens. Astigmatism is caused by the curvature of the cornea that is not the same and helped with a cylindrical lens. Presbiopi caused by accommodation decreases with age added and helped with a cylindrical lens. The color of objects and sources related to three things, namely objects, light, and color constants. Determined by the cone color vision in the retina. Simple theory of color vision evolved initially assume that there are three main colors associated with the maximum sensitivity of the three types of cones. The three primary colors are red, green, and blue. All shades of color can be generated by summing the three primary colors together with a variety of comparisons.

Land theory, known as retineks theory, suggests that the cones do not operate completely independently, but rather organized into three independent systems, one for each cone. The system is called retineks to indicate that the system involves the retina and cerebral cortex. Each retineks establish an independent picture of the field of view. Therefore, comparisons between retineks provide information needed to determine the actual color.

REFERENCE

- Abercrombie, M. et al. (1993). *Kamus Lengkap Biologi*, Edisi ke-8, Terjemahan. Jakarta: Penerbit Erlangga.
- Ackerman, E., Ellis, L.B.M, Williams, L. E. (1998). *Ilmu Biofisika*. Penerjemah: Redjani dan Abdulbasir. Surabaya: Universitas Airlangga.
- Cameron, J. R., J.G. Skofronick. (1978). *Medical Physics*. New York: John Wiley & Sons, Inc.
- Cotterill, R. (2002). *Biophysics*. New York: John Wiley & Sons, Inc.
- Davidovits. (2001). *Physics in Biology and Medicine*, Second Edition. San Diego: A Harcourt Science and Technology.
- Dennis Kunkel. (2004). <http://rabi.phvs.virainia.edu/HTW/book.html>. www.Cellsbio.com
- Freeman. (2004). *The Science of Biology*, 4th Edition, by Sinauer Associates (www.sinauer.com) and (www.whfreeman.com).
- Giancoli, D. C. (1998). *Physics*, Fifth Edition. London: Prentice-Hall International (UK) Limited.
- Glaser, R. (2001). *Biophysics*. Berlin: Springer-Verlag.
- Hughes, W. (1979). *Aspects of Biophysics*. New York: John Wiley & Sons, Inc. http://www.biosci.uga.edu/ahnanac/bio_103/notes/may_15.htm.
- <http://www.cellsalive.com/cells>
- _____, (2004), *The Science of Biology*, 4th Edition, by Sinauer Associates (www.sinauer.com)
- Kimbal, J. W. (1983). *Biologi*, Jilid 2, Edisi ke-5, Terjemahan. Jakarta: Erlangga.
- Lubert, Styer. (2000). *Biokomia*. Vol I. Edisi 4. Penerbit Buku Kedokteran EGC. Jakarta.
- _____, (2001), *How things work: the physics of everyday life* (2nded), (Versi Elektronik). <http://rabi.nhys.vireiniaedu/HTW/book.html>
- Urone, P. P. (1986). *Physics with Health Science Application*. New York: John Wiley & Sons, Inc.
- Webster, J. G. (Ed.). (1998). *Medical Instrumentation*, Third Edition. New York: John Wiley & Sons, Inc.

Ralph Nossal & Harold Leccar. (1991). *Molecular & Cell Biophysics*. Canada. Addison-Wesley Publishing Company.

William Hughes. (1979). *Aspect of Biophysics*. Canada. John & Sons, Inc.

GLOSSARY

Barometer: to measure air pressure tool

Diastolic: minimum blood pressure.

Extensor: muscles that causes the bones to move away from each other.

Flexor: muscles that causes the bones to move closer to each other.

Fluid: Substances that have the ability to flow, liquids and gases ie.

Inersio: Section muscle movement.

Pressure gauge: manometer fluid.

Origo :Section muscle movement.

Resultant vector: resulting from the addition or subtraction of two or more vectors.

Sphygmomanometer: Tools for mengukur blood pressure.

Systolic: maximum pressure in blood.

Pressure measurement (gauge pressure): Pressure melibihi atmospheric pressure.

Tendons: stringy fibers in the muscle system that forwards styles performed by the muscles of the body to another.

Viscosity: friction in a fluid that prevents fluid moving freely and a friction force between the fluid layers adjacent: layers during the moving of one another.

Laminar flow: flow is smooth, so that the fluid layers adjacent to one another glide gently. In this flow of each fluid particles follow a smooth trajectory and particle trajectories do not intersect.

Turbulent floe: flow characterized by small circles resemble whirlpools irregular and called eddy currents.

Axons (nerve fibers): A kind of long tail that propagate signals from the cell body. Axons carry signals biolistrik or nerve impulses from the cell body to the muscles, glands, or other neurons.

Dendrites: input nerve ends are attached to the cell body. Dendrites carry signals from the sensor into the body's cells.

Depolarization: temporary reversal of the membrane potential of neurons.

ECG (electrocardiogram): potential recordings of heart on the skin.

EEG (electroencephalogram): Recording electrical signals from the brain.

EMG (electromyogram): potential recordings muscles during movement.

EOG (Electrooculogram): Recording potential changes caused by eye movements.

ERG (electroretinogram): Recording potential changes produced by the retina of the eye when exposed to a beam of light.

The disease: myasthenia gravis muscle weakness when it perform repetitive tasks.

Myelin: Sheath jointed containing fatty substances and embungkus axons.

Neurons: Nerve cells that form a complex network in the body that receive, process and forward information from one part of the body to other body parts.

Sodium-potassium pump: pumping process that transports sodium ions out of the cell and bring potassium ions enter the same amount.

Action potential of nerve: impulses in the form voltage pulse formed by the cell potential changes from negative to positive and back again during depolarization-repolarization.

Resting potential: when the membrane potential at the axon does not conduct electrical pulses.

The propagation of jumps (saltatory): propagation of action potentials in axons that seems to jump from gap to gap sat next as the pace of the action potential in the axon wrapped in myelin so large compared to the cracks.

Repolarization: Back to the rest of the state of polarity reversal potential.

The nodes of Ranvier: The gaps separating the axon segments of the myelin sheath.

Synapses: Connections between neurons.

Paradoxical sleep or rapid eye movement (REM): high frequency pattern in the EEG during the sleep, the eyes move in this period.

Grand mal: seizures great.

Petit mal seizures that are not so great.

Visual acuity: Sharpness small parts of objects that can be detected by eye.

Ametrope: People who have less than perfect vision.

Aqueous humor: fluid-like water that fills the front of the eye between the lens and the cornea.

Rod (rod): photoreceptors in the retina that is used for night vision and peripheral vision.

Audiogram: Graph generated hearing test.

Emmetrope: People who have good vision.

Infrasonic: sound waves having a frequency below 20 Hz.

Intensity: energy per unit time carried by a wave passing through a unit area perpendicular to the direction of energy flow. The amount related to the level of intensity of sound waves is expressed in decibels (dB).

Iris :Diaphragm muscular reflexes which regulate the light entering the eye.

Reach sounds (audible range): frequency range of sound waves that can be addressed human ear, between 20 Hz and 20,000 Hz.

Cone: photoreceptors in the retina used for daytime vision. Conjunctiva. Transparent: coating that protects the sclera.

The cornea: is transparent and crystal clear arch at the front of the eye that focuses light rays entering the eye.

Hearing cortex: part of the brain which is where the hearing process is formed.

Vision cortex: part of the brain which is where the vision is formed.

Eyepiece: The eyes are doing fine focusing, which can change its shape so as to have the ability to focus objects at various distances.

Auditory: perception of sound by the human ear-brain system.

Perception: of human vision to light through the eye-brain system. Perception consciousness through the senses.

Pupil: small hole in the center of the iris where light enters the eye.

Missing: presbycusis hearing caused by age.

The light-sensitive: retina half of the eyeball that covers the rear. Most of vision is limited to a small area called the macula lutea or yellow spots. Vision of the small parts of objects occurs in a very small area in the yellow spots called the fovea centralis (central fovea).

Land Retineks: theory that suggests that the cones do not operate completely independently, but rather organized into three independent systems, one for each cone.

Sclera: tough membrane, white, and meetings that envelops the entire eye except the cornea.

Snellen: chart Chart used to test the acuity of the eye.

Pitch (pitch): Perception of sound frequencies are determined by Titi tone frequency; higher the frequency, the higher the pitch titi.

Ultrasonic: sound waves having a frequency above 20,000 Hz.

Vitreous humor: gelatinous fluid that fills the eyeball between the lens and the retina.